

SERVICE MANUAL RA-3A CHASSIS

<u>MODEL</u>	<u>COMMANDER</u>	<u>DEST.</u>	<u>CHASSIS NO.</u>	<u>MODEL</u>	<u>COMMANDER</u>	<u>DEST.</u>	<u>CHASSIS NO.</u>
KP-43T75	RM-Y906	US	SCC-P43CA	KP-53N77	RM-Y906	US	SCC-P43DA
KP-43T75	RM-Y906	Canadian	SCC-P43CA	KP-53N77	RM-Y906	Canadian	SCC-P43DA
KP-48S75	RM-Y906	US	SCC-P43BA	KP-53S75	RM-Y906	US	SCC-P43AA
KP-48S75	RM-Y906	Canadian	SCC-P43BA	KP-53S75	RM-Y906	Canadian	SCC-P43AA
				KP-61S75	RM-Y906	US	SCC-P43EA
				KP-61S75	RM-Y906	Canadian	SCC-P43EA

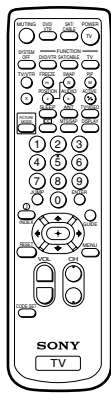

RM-Y906

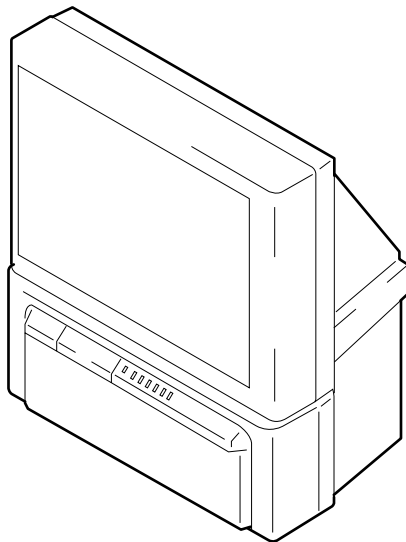

KP-43T75

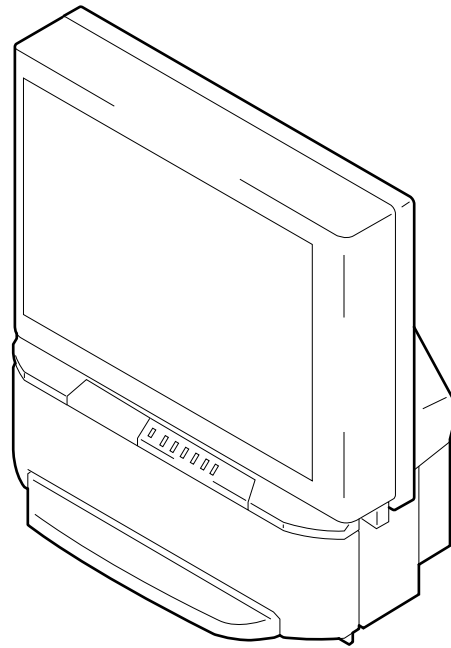

EXCEPT KP-43T75

* Please file according to model size.

43 48 53 61

COLOR REAR VIDEO PROJECTOR
SONY®

SPECIFICATIONS

Projection system

3 picture tubes, 3 lenses, horizontal in-line system

Picture tube

7-inch high-brightness monochrome tubes (6.3 raster size),
with optical coupling and liquid cooling system

Projection lenses

High performance, large diameter hybrid lens F1.05

Television system

American TV standard

Channel coverage

VHF: 2–13/UHF: 14–69/CATV: 1–125

Antenna

75 ohm external terminal for VHF/UHF

Screen size (measured diagonally)

43 inches (KP-43T75)

48 inches (KP-48S75)

53 inches (KP-53S75/53N77)

61 inches (KP-61S75)

Inputs/outputs

VIDEO 1 IN

VIDEO 2 INPUT

S VIDEO IN (4-pin mini DIN):

Y: 1 Vp-p, 75-ohms unbalanced, sync negative

C: 0.286 Vp-p (Burst signal), 75 ohms

VIDEO (phono jack): 1 Vp-p, 75-ohms unbalanced, sync
negative

AUDIO (phono jacks): 500 mVrms (100% modulation),

Impedance: 47 kilohms

VIDEO 3 IN

S VIDEO IN (4-pin mini DIN):

Y: 1 Vp-p, 75-ohms unbalanced, sync negative

C: 0.286 Vp-p (Burst signal), 75 ohms

VIDEO (phono jack): 1 Vp-p, 75-ohms unbalanced, sync
negative

Y: 1 Vp-p, 75 ohms, sync negative

PB: 0.7 Vp-p, 75 ohms

PR: 0.7 Vp-p, 75 ohms

AUDIO (phono jacks): 500 mVrms (100% modulation),

Impedance: 47 kilohms

MONITOR OUT

VIDEO (phono jack): 1 Vp-p, 75-ohms unbalanced, sync
negative

AUDIO (phono jacks): 470 mVrms (100% modulation),

Impedance: 470 ohms

AUDIO (VAR/FIX) OUT (phono jacks): 500 mVrms

(100% modulation), Impedance: 470 ohms

CONTROL S OUT: minijack

Speaker

For KP-53N77

Tweeter: 66 mm (2 5/8") x 2

Woofer: 130 mm (5 1/8") x 2

Except for KP-53N77

100 mm (4") x 2

Speaker output

15W x 2 (Except for KP-53N77)

20 W x 2 (KP-53N77)

Power requirement

120 V AC, 60 Hz

Power consumption

In use (Max.): 160 W

In standby: 1 W

Dimensions (W/H/D)

965 x 1,058 x 510 mm (38 x 41 5/8 x 20 1/8 inches)
(KP-43T75)

1,105 x 1,338 x 579 mm (43 1/2 x 52 5/8 x 22 3/4 inches)
(KP-48S75)

1,216 x 1,417 x 632 mm (47 7/8 x 55 3/4 x 24 7/8 inches)
(KP-53S75)

1,216 x 1,417 x 632 mm (47 7/8 x 55 3/4 x 24 7/8 inches)
(KP-53N77)

1,370 x 1,560 x 670 mm (54 x 61 3/8 x 26 3/8 inches)
(KP-61S75)

Mass

64.6 kg (141 lbs 10 oz) (KP-43T75)

64 kg (141 lbs 2 oz) (KP-48S75)

67.6 kg (149 lbs) (KP-53S75)

75.2 kg (165 lbs 13 oz) (KP-53N77)

84.6 kg (186 lbs 8 oz) (KP-61S75)

Supplied accessories

Remote control RM-Y906 (1)

Batteries (2) size AA (R6)

Optional accessories

Connecting cables

RK-G34, RK-74A, RK-G69HG, VMC-10HG,

VMC-720M, VMC-810S/820S, YC-15V/30V

U/V mixer EAC-66

Design and specifications are subject to change without notice.

SAFETY CHECK-OUT

(US model only)

After correcting the original service problem, perform the following safety checks before releasing the set to the customer:

1. Check the area of your repair for unsoldered or poorly-soldered connections. Check the entire board surface for solder splashes and bridges.
2. Check the interboard wiring to ensure that no wires are "pinched" or contact high-wattage resistors.
3. Check that all control knobs, shields, covers, ground straps, and mounting hardware have been replaced. Be absolutely certain that you have replaced all the insulators.
4. Look for unauthorized replacement parts, particularly transistors, that were installed during a previous repair. Point them out to the customer and recommend their replacement.
5. Look for parts which, through functioning, show obvious signs of deterioration. Point them out to the customer and recommend their replacement.
6. Check the line cords for cracks and abrasion. Recommend the replacement of any such line cord to the customer.
7. Check the condition of the monopole antenna (if any). Make sure the end is not broken off, and has the plastic cap on it. Point out the danger of impalement on a broken antenna to the customer, and recommend the antenna's replacement.
8. Check the B+ and HV to see they are at the values specified. Make sure your instruments are accurate; be suspicious of your HV meter if sets always have low HV.
9. Check the antenna terminals, metal trim, "metallized" knobs, screws, and all other exposed metal parts for AC leakage. Check leakage as described below.

LEAKAGE TEST

The AC leakage from any exposed metal part to earth ground and from all exposed metal parts to any exposed metal part having a return to chassis, must not exceed 0.5mA (500 microampers). Leakage current can be measured by any one of three methods.

1. A commercial leakage tester, such as the Simpson 229 or RCA WT-540A. Follow the manufacturers' instructions to use these instruments.
2. A battery-operated AC milliammeter. The Data Precision 245 digital multimeter is suitable for this job.
3. Measuring the voltage drop across a resistor by means of a VOM or battery-operated AC voltmeter. The "limit" indication is 0.75V, so analog meters must have an accurate low-voltage scale. The Simpson 250 and Sanwa SH-63Trd are examples of a passive VOM that is suitable. Nearly all battery operated digital multimeters that have a 2V AC range are suitable. (See Fig. A)

HOW TO FIND A GOOD EARTH GROUND

A cold-water pipe is guaranteed earth ground; the cover-plate retaining screw on most AC outlet boxes is also at earth ground. If the retaining screw is to be used as your earth-ground, verify that it is at ground by measuring the resistance between it and a cold-water pipe with an ohmmeter. The reading should be zero ohms. If a cold-water pipe is not accessible, connect a 60-100 watts trouble light (not a neon lamp) between the hot side of the receptacle and the retaining screw. Try both slots, if necessary, to locate the hot side of the line, the lamp should light at normal brilliance if the screw is at ground potential. (See Fig. B)

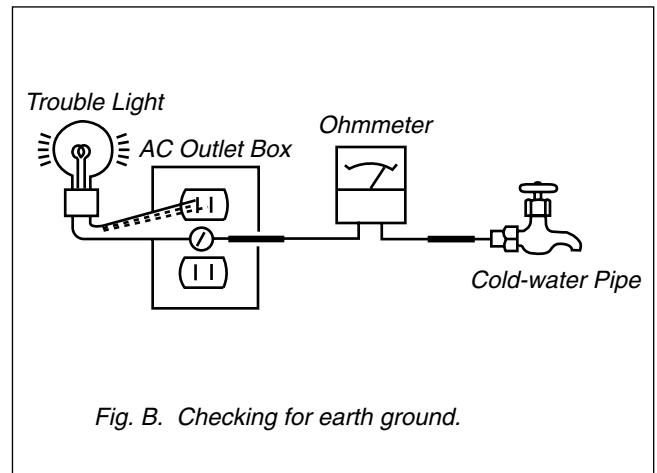
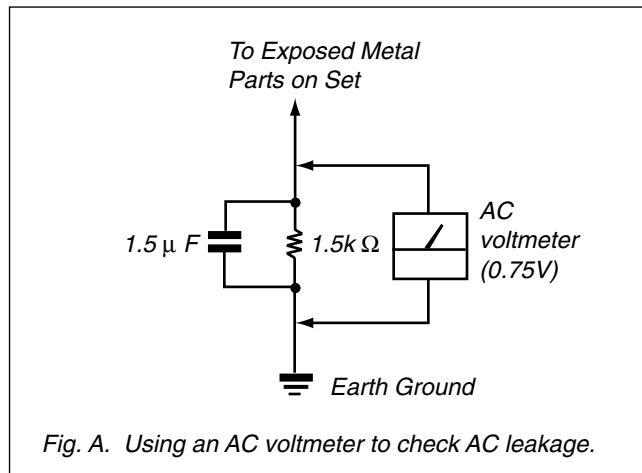

SELF DIAGNOSIS FUNCTION

1. Summary of Self-Diagnosis Function

- This device includes a self-diagnosis function.
- In case of abnormalities, the TIMER/STANDBY indicator automatically blinks. It is possible to predict the abnormality location by the number of blinks. The Instruction Manual describes blinking of the TIMER/STANDBY indicator.
- If the symptom is not reproduced sometimes in case of a malfunction, there is recording of whether a malfunction was generated or not. Operate the remote command to confirm the matter on the screen and to predict the location of the abnormality.

2. Diagnosis Items and Prediction of Malfunction Location

- When a malfunction occurs the TIMER/STANDBY indicator only blinks for one of the following diagnosis items. In case of two or more malfunctions, the item which first occurred blinks. If the malfunctions occurred simultaneously, the item with the lower blink count blinks first.
- The screen display displays the results regarding all the diagnosis items listed below. The display “0” means that no malfunctions occurred.

Diagnosis item	TIMER/STANDBY Indicator Number of blinks	Supposed malfunction	Condition	Self-diagnosis screen display, Diagnosis item: Results
• Power not ON	0	[Standby Power Supply System] F601 open. R607 open. Q601 short circuit [Main Power Supply System] IC601 and R612 are broken. VDR601 short-circuit	Cannot turn on the power. LED doesn't blink.	
+B OCP detection	2 times	Short circuit of power supply system in each circuit.	Goes to the standby mode Short circuit of +B line	2 : +B OCP 000
+B OVP detection	3 times	T603 pin 78 open. R672 open.	Goes to the standby mode Malfunction of power supply circuit	3 : +B OVP 000
Vertical deflection stop	4 times	IC1509(V out) is broken. Q1505(V Pulse Buffer) is broken.	Raster goes to one line horizontally, A and then video signal is muted.	4 : V Stop 000
Video out abnormality detection	5 times	Video out, Q705, 732, 761 and others in C board circuit. Q218, 219, 220 (A board)	TIMER/STANDBY LED blinks approx. 30 seconds, and then blinks for the self diagnosis.	5 : AKB 000
Horizontal deflection stop	6 times	C515, 516 open. IC206(YC Jungle) is broken.	Raster doesn't appear.	6 : H Stop 000
Audio abnormality detection	8 times	IC406(Audio amp.) is broken. PS401, 402 open.	The sound is not out. Goes to the standby mode	8 : Audio 000

* : 000 the range of values for number of operations is 000-255. For 256 or higher there is no count up and the number remains at 255.

3. Blinking count display of TIMER/STANDBY indicator

* One blink is not used for self-diagnosis.

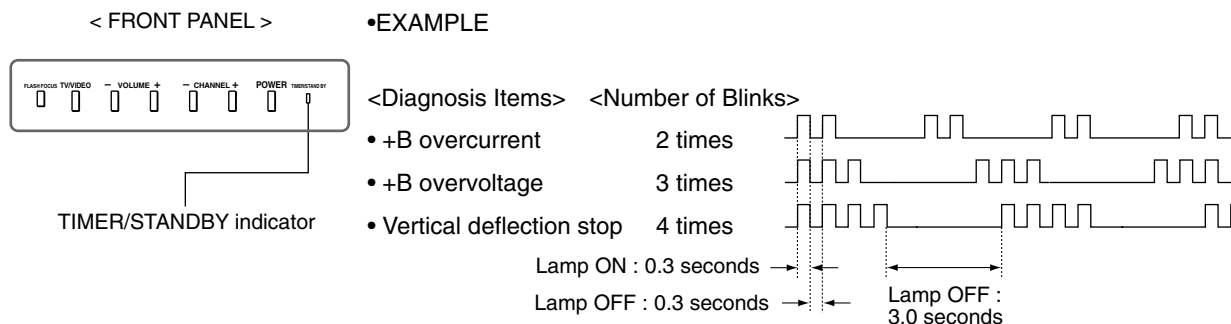

Release of TIMER/STANDBY indicator blinking.

- The TIMER/STANDBY indicator blinking display is released by turning OFF the power switch on the TV main unit or removing the plug from the power.

6. Self-diagnosis function operation

- OCP** Low B and +B line detect DET SHORT, and shut-down POWER ON RELAY.
Reset by turning power on/off.
In case of +B is loaded approx. 1.3A or more, microcomputer detects it via IC651.
- OVP** In case of +B becomes approx. 150V or more, POWER ON RELAY shuts down and microcomputer detects it via IC651.
Reset by turning power on/off just the same as OCP.
- V Stop** In case of microcomputer detects 2 seconds or more interval of V Pulse, Reference Pulse turns off by turning off the picture signal in YC Jungle IC (IC206).
After the picture signal turns off, V Pulse is regenerated 2 seconds or more, the picture signal turns on.
- AKB** IK detection. Makes LED blinking in case of microcomputer doesn't detect IK returns of IC206 CXA2147Q 30 seconds or more.
- H Stop** In case of HV becomes 33kV or more, IC502 detects it and shut-down H Drive Pulse.
Microcomputer receives H Stop data from IC206 and makes LED blinking.
- Audio** In case of DC component overlaps the output of Audio Amp., microcomputer detects it and makes LED blinking.
Microcomputer forces to shut down the power.

Self-diagnosis block diagram

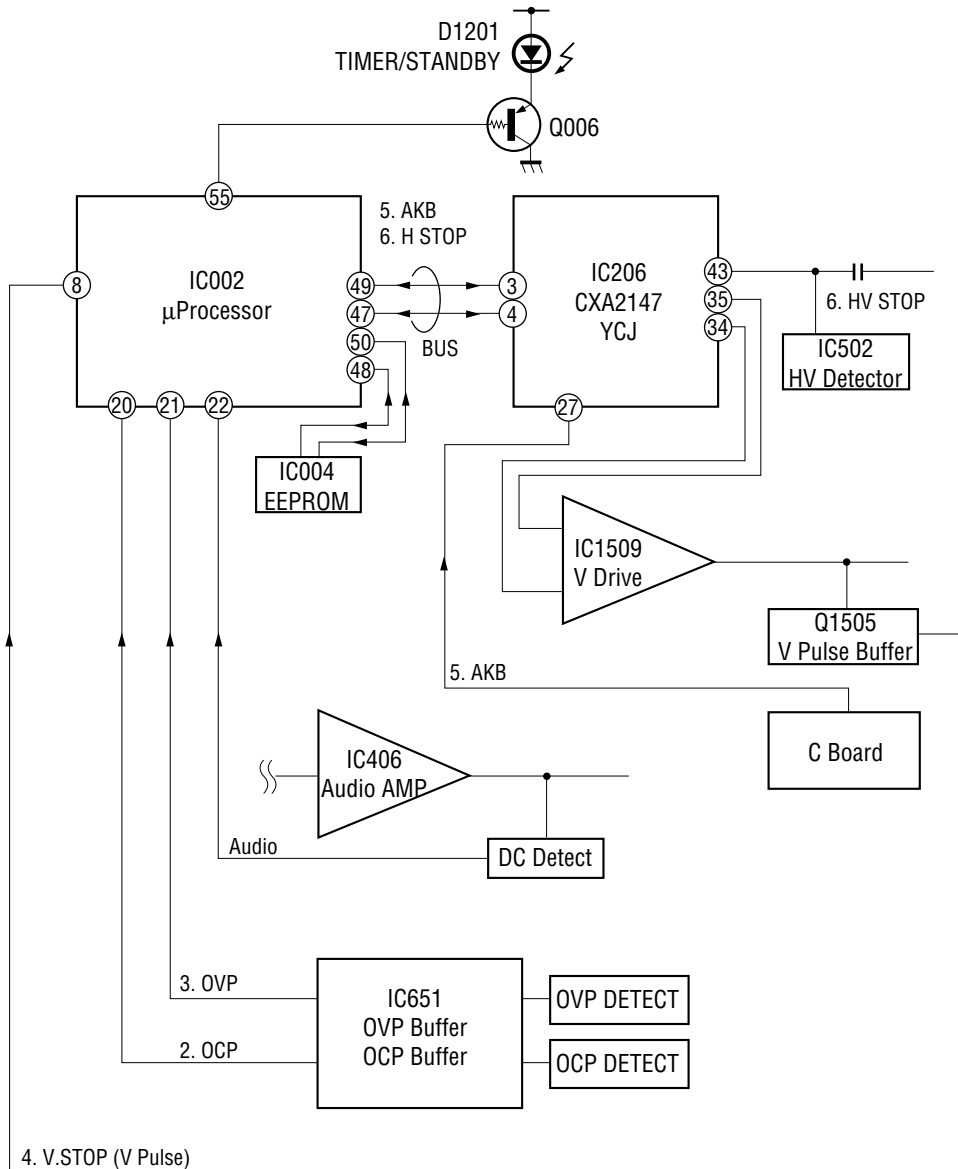

TABLE OF CONTENTS

<u>Section</u>	<u>Title</u>	<u>Page</u>	<u>Section</u>	<u>Title</u>	<u>Page</u>
	SELF DIAGNOSIS FUNCTION	4	5. CIRCUIT ADJUSTMENTS		
1. GENERAL			5-1.	TV Input Sub Contrast Adjustment (VPNT-SCON)	49
	Remote Control	9	5-2.	Video Input Sub-HUE and Sub-Color Adjustment (VPNT-SHUE, SCOL)	49
	Precautions	9	5-3.	Component Input Sub-HUE and SubColorAdjustment (DAC-UVSH, UVSC)	49
	Installing and Connecting the Projection TV	10	5-4.	P & P Sub Contrast Adjustment (SC-SYDR)	49
	Basic Set Up	15	5-5.	Sub-HUE, Sub-Color and Main Contrast Adjustment (MC-MYDR, MSHU, MSCL, SC-SSHU, SSCL)	50
	Using Your New Projection TV	16	5-6.	Bar Display Position Adjustment (OP-DISP)	50
	Adjusting Your SET UP (menus)	19	5-7.	PIP Position Adjustment (PI-PIPH, PIPV)	50
	Operating Video Equipment	30			
	Operating a Cable Box or Satellite Receiver (SAT)	31	6. DIAGRAMS		
	Troubleshooting	31	6-1.	Block Diagram (1)	51
2. DISASSEMBLY				Block Diagram (2)	53
	2-1. Rear Board Removal	33		Block Diagram (3)	59
	2-2. Chassis Assy Removal	33		Block Diagram (4)	63
	2-3. Service Position	33		Block Diagram (5)	65
	2-4. HA Board and HB Board Removal (Except KP-43T75)	33	6-2.	Frame Schematic Diagram	67
	2-5. HA Board and HB Board Removal(KP-43T75)	34	6-3.	Circuit Boards Location	70
	2-6. Mirror Cover Removal	34	6-4.	Printed Wiring Boards and Schematic Diagrams	70
	2-7. Beznets Assy Removal	34		• A (1/3)Board	71
	2-8. HC Board and S Board Removal	34		• A (2/3)Board	75
	2-9. A Board and G Board Removal	35		• A (3/3)Board	79
	2-10. Picture Tube Removal	35		• G Board	87
	2-11. High-Voltage Cable Installation and Removal	35		• CG Board	94
3. SET-UP ADJUSTMENTS				• CR Board	95
	3-1. Screen Voltage Adjustment (Coarse Adjustment)	36		• CB Board	95
	3-2. Screen (G2) Adjustment (Fine Adjustment)	36		• HA Board	97
	3-3. Deflection York Tilt Adjustment	36		• HC Board	97
	3-4. Focus Lens Adjustment	36		• HB Board	98
	3-5. Focus VR Adjustment	37	6-5.	Semiconductors	99
	3-6. 2-Pole Magnet Adjustment (Green, Red)	37	7. EXPLODED VIEWS		
	3-7. 4-Pole Magnet Adjustment	37	7-1.	Cover (KP-43T75)	101
	3-8. Defocus Adjustment (Blue)	37	7-2.	Cover (KP-48S75)	102
	3-9. Electrical Adjustment by Remote Commander	38	7-3.	Cover (KP-53N77/53S75/61S75)	103
	3-10. Registration Adjustment (PJE)	43	7-4.	Chassis (KP-43T75)	104
	3-11. Auto Registration Error Code List	46	7-5.	Chassis (Except KP-43T75)	105
4. SAFETY RELATED ADJUSTMENTS			7-6.	Picture Tube	106
	4-1. HV Regulation Circuit Check and Adjustment	47	8. ELECTRICAL PARTS LIST		107
	4-2. HV Hold Down Circuit Operation and Adjustment ..	47			
	4-3. +B Max Voltage Confirmation	47			
	4-4. +B OVP Confirmation	48			

(CAUTION)

SHORT CIRCUIT THE ANODE OF THE PICTURE TUBE AND THE ANODE CAP TO THE METAL CHASSIS, CRT SHIELD, OR CARBON PAINTED ON THE CRT, AFTER REMOVING THE ANODE.

WARNING!!

AN ISOLATION TRANSFORMER SHOULD BE USED DURING ANY SERVICE TO AVOID POSSIBLE SHOCK HAZARD, BECAUSE OF LIVE CHASSIS. THE CHASSIS OF THIS RECEIVER IS DIRECTLY CONNECTED TO THE AC POWER LINE.

SAFETY-RELATED COMPONENT WARNING!!

COMPONENTS IDENTIFIED BY SHADING AND MARK \triangle ON THE SCHEMATIC DIAGRAMS, EXPLODED VIEWS AND IN THE PARTS LIST ARE CRITICAL TO SAFE OPERATION. REPLACE THESE COMPONENTS WITH SONY PARTS WHOSE PART NUMBERS APPEAR AS SHOWN IN THIS MANUAL OR IN SUPPLEMENTS PUBLISHED BY SONY. CIRCUIT ADJUSTMENTS THAT ARE CRITICAL TO SAFE OPERATION ARE IDENTIFIED IN THIS MANUAL. FOLLOW THESE PROCEDURES WHENEVER CRITICAL COMPONENTS ARE REPLACED OR IMPROPER OPERATION IS SUSPECTED.

(ATTENTION)

APRES AVOIR DECONNECTE LE CAP DE L'ANODE, COURT-CIRCUITER L'ANODE DU TUBE CATHODIQUE ET CELUI DE L'ANODE DU CAP AU CHASSIS METALLIQUE DE L'APPAREIL, OU AU COUCHE DE CARBONE PEINTE SUR LE TUBE CATHODIQUE OU AU BLINDAGE DU TUBE CATHODIQUE.

ATTENTION!!

AFIN D'EVITER TOUT RISQUE DE ELECTROCUTION PROVENANT D'UN CHASSIS SOUS TENSION, UN TRANSFORMATEUR D'ISOLEMENT DOIT ETRE UTILISE LORS DE TOUT DEPANAGE. LE CHASSIS DE CE RECEPTEUR EST DIRECTEMENT RACCORDE A L'ALIMENTATION SECTEUR.

ATTENTION AUX COMPOSANTS RELATIFS A LA
SECURITE!!

LES COMPOSANTS IDENTIFIES PAR UNE TRAME ET PAR UNE MAPQUE \triangle SUR LES SCHEMAS DE PRINCIPE, LES VUES EXPLOSEES ET LES LISTES DE PIECES CONT D'UNE IMPORTANCE CRITIQUE POUR LA SECURITE DU FONCTIONNEMENT. NE LES REMPLACER QUE PAR DES COMPOSANTS SONY DONT LE NUMERO DE PIECE EST INDIQUE DANS LE PRESENT MANUEL OU DANS DES SUPPLEMENTS PUBLIES PAR SONY. LES REGLAGES DE CIRCUIT DONT L'IMPORTANCE EST CRITIQUE POUR LA SECURITE DU FONCTIONNEMENT SONT IDENTIFIES DANS LE PRESENT MANUEL. SUIVRE CES PROCEDURES LORS DE CHAQUE REMPLACEMENT DE COMPOSANTS CRITIQUES, OU LORSQU'UN MAUVAIS FONCTIONNEMENT EST SUSPECTE.

SECTION 1

GENERAL

The operating instructions mentioned here are partial abstracts from the Operating Instructions Manual. The page numbers of the Operating Instruction Manual remain as in the manual. (Part no : 4-077-171-11)

Remote Control

In the instructions that follow, we will refer to the buttons on your remote control. Keep this flap unfolded and use this page for reference.

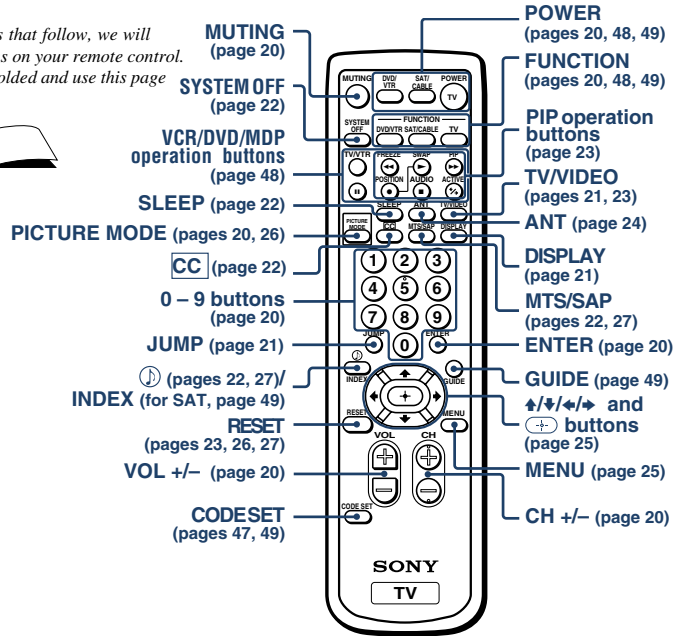
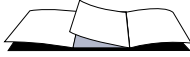

Getting to know the buttons on the remote control

Names of the buttons on the remote control are presented in different colors to represent the available functions.

Button color

- Transparent Press to select the component you want to control; e.g. VTR (VCR)/MDP/DVD Player, SAT (satellite receiver)/CABLE, or projection TV.
- Green Buttons relevant to power operations, like turning the projection TV, SAT/CABLE, or VTR (VCR)/MDP/DVD Player on or off

Label color

- White TV/VTR (VCR)/MDP/DVD Player/SAT (satellite receiver)/CABLE operation buttons
- Yellow PIP operation buttons
- Blue SAT operation buttons
- Green S-Link operation buttons
- Pink DVD Player operation buttons

For a detailed explanation of most buttons, see "Watching the TV" on page 20.

Precautions

Safety

- Operate the projection TV only on 120 V AC.
- The plug is designed, for safety purposes, to fit into the wall outlet only one way. If you are unable to insert the plug fully into the outlet, contact your dealer.
- If any liquid or solid object should fall inside the cabinet, unplug the projection TV immediately and have it checked by qualified service personnel before operating it further.
- If you will not be using the projection TV for several days, disconnect the power by pulling the plug itself. Never pull on the cord.

Note on cleaning

Clean the cabinet of the projection TV with a dry soft cloth. To remove dust from the screen, wipe it gently with a soft cloth. Stubborn stains may be removed with a cloth slightly dampened with solution of mild soap and warm water. Never use strong solvents such as thinner or benzine for cleaning.

If the picture becomes dark after using the projection TV for a long period of time, it may be necessary to clean the inside of the projection TV. Consult qualified service personnel.

Installing

- To prevent internal heat buildup, do not block the ventilation openings.
- Do not install the projection TV in a hot or humid place, or in a place subject to excessive dust or mechanical vibration.
- Avoid operating the projection TV at temperatures below 5° C (41° F).
- If the projection TV is transported directly from a cold to a warm location, or if the room temperature changes suddenly, the picture may be blurred or show poor color. In this case, please wait a few hours to let the moisture evaporate before turning on the projection TV.
- To obtain the best picture, do not expose the screen to direct illumination or direct sunlight. It is recommended to use spot lighting directed down from the ceiling or to cover the windows that face the screen with opaque drapery. It is desirable to install the projection TV in a room where the floor and walls are not of a reflective material.

Installing and Connecting the Projection TV

Carrying Your Projection TV

Carrying the projection TV requires three or more people.

For KP-48S75/53S75/53N77/61S75

The projection TV has been equipped with casters for easy movement on a hard surface. Please move your projection TV using the casters.

Installing the Projection TV

Recommended viewing area (Horizontal)

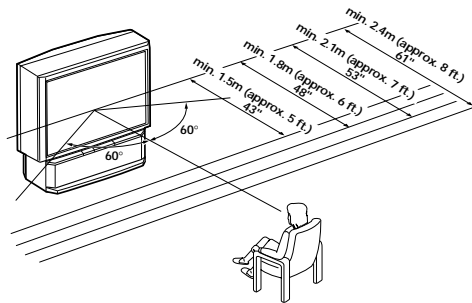

Recommended viewing area (Vertical)

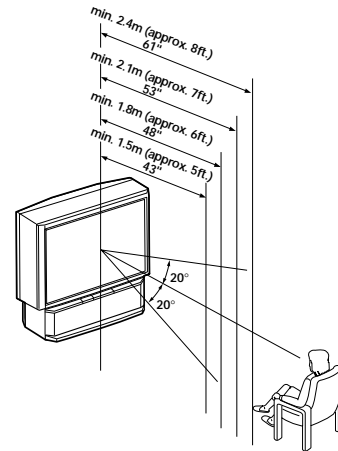

7

Installing and Connecting the Projection TV (continued)

Connector Types

You may find it necessary to use some of the following connector types during set up.

Coaxial cable

Standard TV cable and antenna cable

Plug Type



Screw-on Type



S Video cable

High quality video cable for enhanced picture quality



Audio/Video cable



Video - Yellow
Audio (Left) - White
Audio (Right) - Red

Some DVD Players and DTV Receivers are equipped with the following three video connectors.

Y - Green
PB (Cb, Cb or B-Y) - Blue
PR (Cr, Cr or R-Y) - Red

CONTROL S cable

Sony cable for CONTROL S connection. This feature is exclusive to Sony products and allow greater control of all Sony equipment.

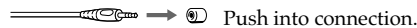

About the CONTROL S OUT jack

To control other Sony equipment with the projection TV's remote control, connect the CONTROL S IN jack of the equipment to the CONTROL S OUT jack on the projection TV with the CONTROL S cable.

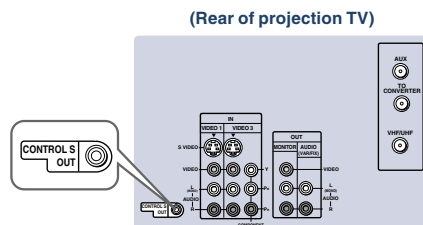

Making Connections

Connecting directly to a cable or an antenna

The connection you choose will depend on the cable found in your home. Newer homes will be equipped with standard coaxial cable (see **A**); older homes will probably have 300-ohm twin lead cable (see **B**); still other homes may contain both (see **C**). Use 75-ohm coaxial cable for improved picture quality (see **A**).

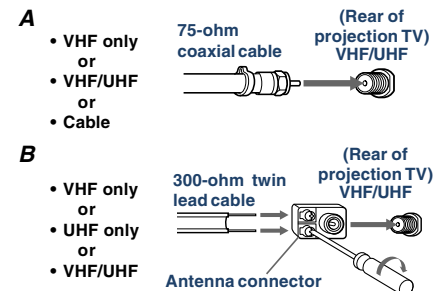

8

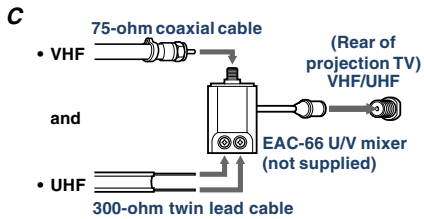

Cable or antenna

This is the simplest connection. Connection is made directly from the cable or antenna to the projection TV.

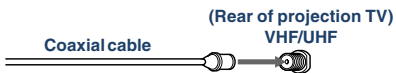

Cable and antenna

You may find it convenient to use the following set up if your cable provider does not feature local channels that you are able to receive using an antenna.

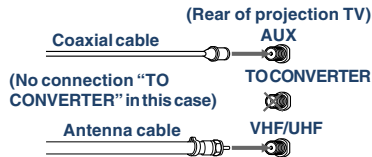

Select Cable or ANT mode by pressing ANT on the remote control.

Connecting a cable box

Some pay cable TV systems use scrambled or encoded signals that require a cable box* to view all channels.

Also, set "Cable" to "On" in the Channel Set Up menu (page 31).

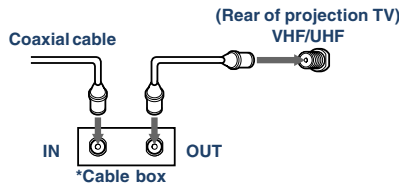

Cable box and cable

Some pay cable TV systems use scrambled or encoded signals requiring a cable box* only for certain channels (e.g. HBO, SHOWTIME, etc.)

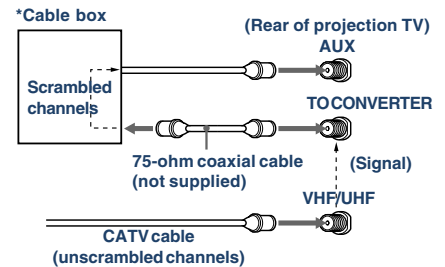

For this set up, you can switch between scrambled channels (through your cable box), and normal (CATV) channels by pressing ANT on your remote control.

Notes:

- You may be able to program your Sony remote control to operate your cable box. (see "Operating a Cable Box or Satellite Receiver (SAT)" on page 49)
- During PIP or Favorite Channel viewing, the AUX input can only be viewed in the main picture.

9

Installing and Connecting the Projection TV (continued)

Connecting a cable TV system/ antenna to a VCR

- Attach the coaxial cable from the incoming cable connection or antenna to VHF/UHF IN on the VCR.
- Using a coaxial cable, connect VHF/UHF OUT on the VCR to VHF/UHF on the projection TV.
- Using AUDIO and S VIDEO* cables, connect AUDIO and S VIDEO OUT on the VCR to AUDIO and S VIDEO IN on the projection TV (White-AUDIO Left, Red-AUDIO Right**).

Connecting a VCR and projection TV to a cable box

- Connect the single (input) jack of the splitter to the incoming cable connection, and connect the other two (output) jacks (using the coaxial cable) to IN on the cable box and VHF/UHF on the projection TV.
- Using a coaxial cable, connect OUT on the cable box to VHF/UHF IN on the VCR.
- Using AUDIO and S VIDEO* cables, connect AUDIO and S VIDEO OUT on the VCR to AUDIO and S VIDEO IN on the projection TV (White-AUDIO Left, Red-AUDIO Right**).

Disconnect all power sources before making any connections.

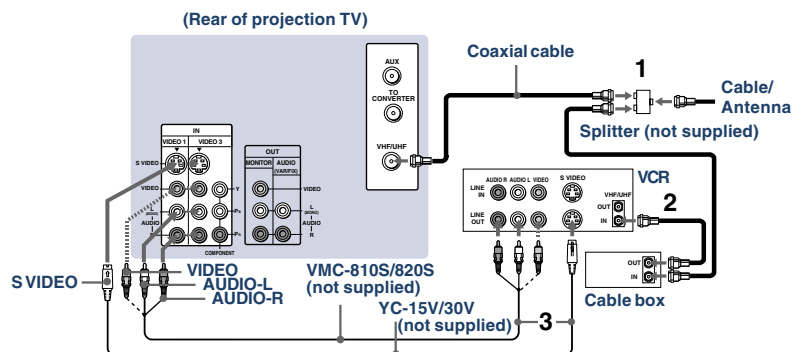
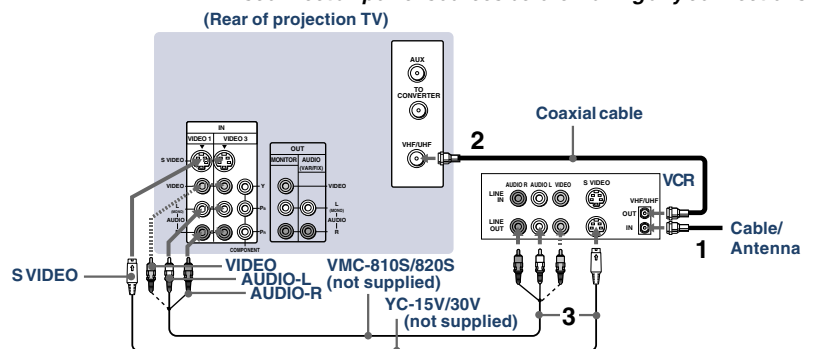

Disconnect all power sources before making any connections.

Note:

- To view scrambled channels through the cable box, select the video input which the cable box is connected to by pressing TV / VIDEO.
- If your VCR is not equipped with S VIDEO, use a VIDEO cable (yellow) instead of the S VIDEO cable.
- If you are connecting a monaural VCR, connect only the single audio output to the left (MONO) input on the projection TV.

Connecting a satellite receiver (SAT)

- 1 Connect the cable from the satellite antenna to the satellite receiver.
- 2 Attach the coaxial cable from the incoming cable connection or antenna to VHF / UHF on the projection TV.
- 3 Using AUDIO and S VIDEO cables, connect AUDIO and S VIDEO OUT on the satellite receiver to AUDIO and S VIDEO IN on the projection TV (White-AUDIO Left, Red-AUDIO Right).

Note:

- To view input from the satellite receiver, select the video input which the satellite receiver is connected to by pressing TV / VIDEO on the remote control.

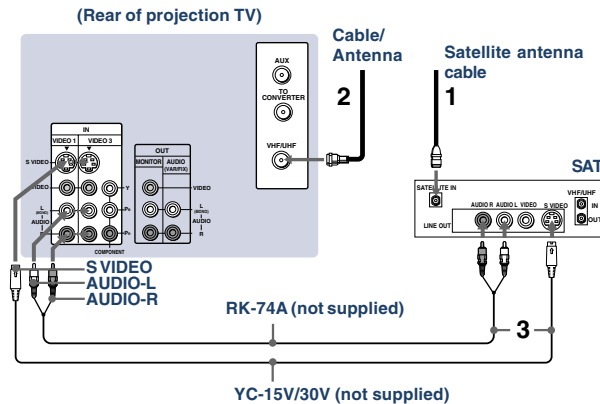

Installing and Connecting the Projection TV (continued)

Disconnect all power sources before making any connections.

Connecting a satellite receiver (SAT) and a VCR

- 1 Connect the cable from the satellite antenna to the satellite receiver.
- 2 Attach the coaxial cable from the incoming cable connection or antenna to VHF / UHF IN on the VCR.
- 3 Using a coaxial cable, connect VHF / UHF OUT on the VCR to VHF / UHF on the projection TV.
- 4 Using AUDIO and S VIDEO* cables, connect AUDIO and S VIDEO OUT on the satellite receiver to AUDIO and S VIDEO IN on the VCR.
- 5 Using AUDIO and S VIDEO* cables, connect AUDIO and S VIDEO OUT on the VCR to AUDIO and S VIDEO IN on the projection TV (White-AUDIO Left, Red-AUDIO Right).

*If your VCR is not equipped with S VIDEO, use a VIDEO cable (yellow) instead of the S VIDEO cable.

Note:

- To view input from the satellite receiver or VCR, select the video input which your satellite receiver or VCR is connected to by pressing TV / VIDEO on the remote control.

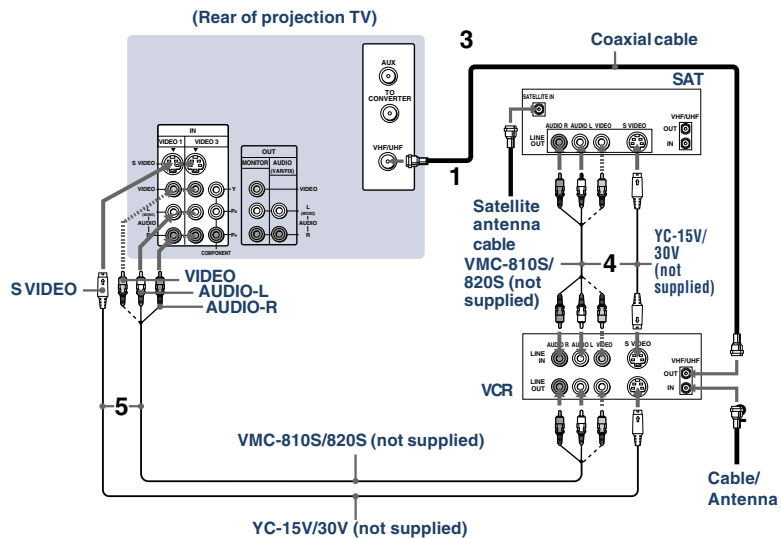

Connecting a DTV (digital television) receiver

Disconnect all power sources before making any connections.

Before connecting, be sure to read the Operating Instructions of the DTV receiver.

- 1 Attach the coaxial cable from the roof antenna to VHF/UHF IN (DTV) on the DTV receiver.
- 2 Using AUDIO and S VIDEO cables, connect AUDIO and S VIDEO OUT on the DTV receiver to AUDIO and S VIDEO IN on the projection TV (White-AUDIO Left, Red-AUDIO Right).

Note:

- If your DTV receiver supports 480i signal from YPbPr, you can connect Y, Pb and Pr of VIDEO OUT on the DTV receiver to Y, Pb and Pr of VIDEO 3 IN on the projection TV using VIDEO cables.

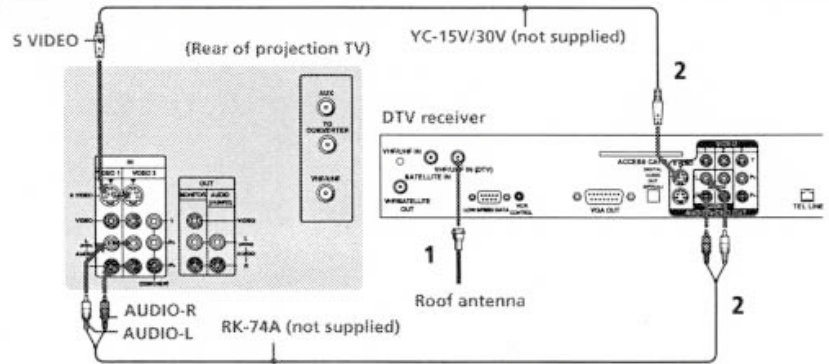

Connecting a camcorder

Use this connection to view a picture directly from your camcorder.

- 1 Using AUDIO and S VIDEO* cables, connect AUDIO and S VIDEO OUT on the camcorder to AUDIO and S VIDEO IN inside the drop-down panel on the front of the projection TV (White-AUDIO Left, Red-AUDIO Right**).
- 2 Press VIDEO 2 to select the video inputs from a camcorder.

- * If your camcorder is not equipped with S VIDEO, use a VIDEO cable (yellow) instead of the S VIDEO cable.
- ** If you are connecting a monaural camcorder, connect only the single audio output to the left (MONO) input on the projection TV.

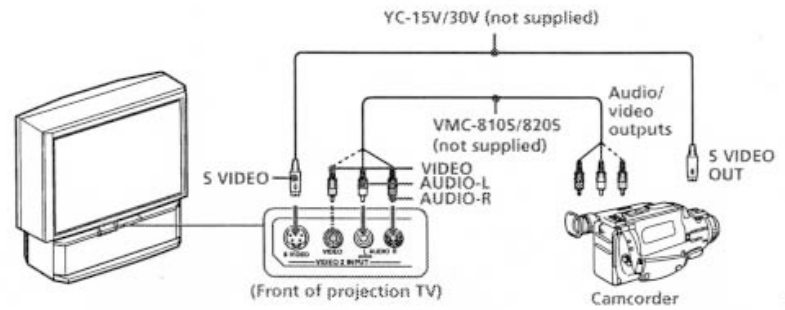

Installing and Connecting the Projection TV (continued)

Disconnect all power sources before making any connections.

Connecting two VCRs for tape editing

By connecting a second VCR to MONITOR OUT, you can record a program being played by the primary VCR to the second VCR or perform tape editing and dubbing.

- 1 Connect the VCR intended for playback using the connection instructions on page 6 of this manual.
- 2 Using an AUDIO/VIDEO cable, connect AUDIO and VIDEO IN on the VCR intended for recording to AUDIO and VIDEO OUT of MONITOR OUT on the projection TV.

Notes:

- Do not change the input signal while editing through MONITOR OUT.
- When connecting a single VCR to the projection TV: if VCR LINE OUT is connected to VIDEO IN on the projection TV, **do not** connect MONITOR OUT on the projection TV to the VCR LINE INPUT (see right). Doing so will cause program interference and other viewing problems.

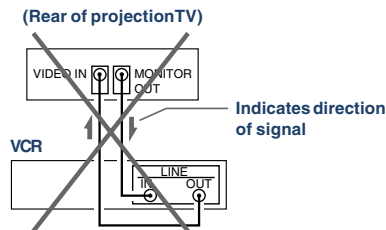
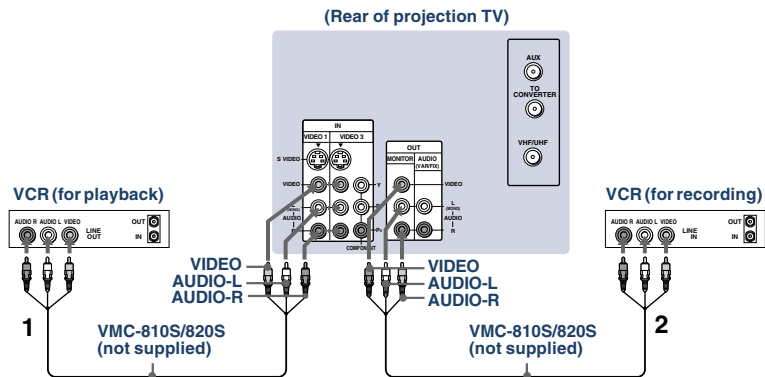

Connecting a DVD Player (Upper illustration)

Using an AUDIO and S VIDEO cables, connect AUDIO and S VIDEO IN on the projection TV to AUDIO and S VIDEO OUT on the DVD Player (White-AUDIO Left, Red-AUDIO Right).

Connecting a DVD Player with component video output connectors (Lower illustration)

- Using an AUDIO cable, connect AUDIO of LINE OUT on the DVD Player to AUDIO of VIDEO 3 IN on the projection TV (White-AUDIO Left, Red-AUDIO Right).
- Using three yellow VIDEO cables, connect Y, P_B, and P_R of COMPONENT VIDEO OUT on the DVD Player to Y, P_B, and P_R of VIDEO 3 IN on the projection TV.

Notes:

- Since the high quality pictures on a DVD disc contain a lot of information, picture noise may appear. In this case, adjust "Noise Reduction" in the Video menu. (see "Noise Reduction" on page 22)
- Some DVD Player terminals may be labeled differently. If so, connect as follows:
Connect Y (green) to Y.
Connect P_B (blue) to C_B, C_b or B-Y.
Connect P_R (red) to C_R, C_r or R-Y.

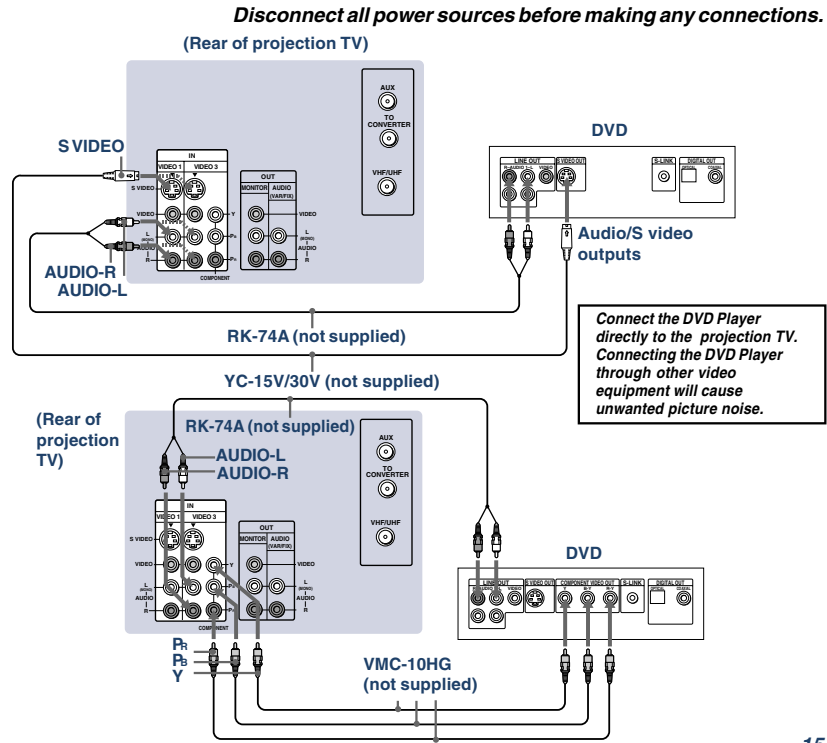

15

Installing and Connecting the Projection TV (continued)

Connecting an audio system

For more dynamic sound, connect an audio system to the projection TV.

- Using an AUDIO cable, connect AUDIO (VAR/FIX) OUT on the projection TV to one of the unused Line inputs (e.g. Tape-2, AUX1, etc.) on the stereo.
- Set the stereo to the chosen Line input and use the Audio menu to set the audio output and switch the TV's speakers off. (see "Audio Out" and "Speaker" on page 28)

Note:

- You can adjust VOLUME, "Bass," "Treble," "Balance," "MTS/SAP" and "Effect" with the supplied remote control. The control items except VOLUME can be adjusted only when "Audio Out" is set to "Variable" in the Audio menu. (see "Audio Out" on page 28)

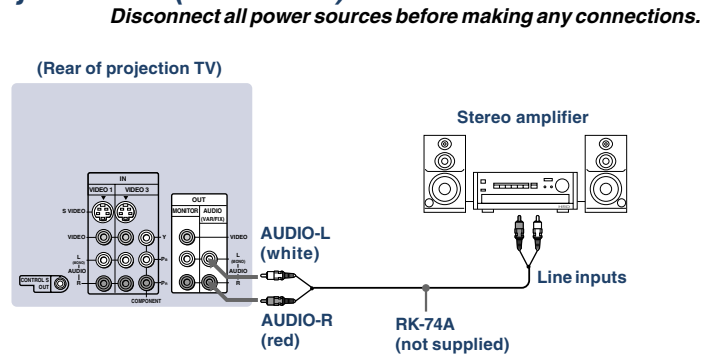

16

Connecting a Sony SAVA series speaker system

Use this connection to control the speaker's Dolby* Pro Logic surround system and super woofer mode with the remote control. (see "SAVA SP Control" on page 28)

- 1 Using the AUDIO cable supplied with the speaker to AUDIO (VAR/FIX) OUT on the projection TV.
- 2 Using the CONTROL S cable, connect CONTROL S IN on the speaker to CONTROL S OUT on the projection TV.

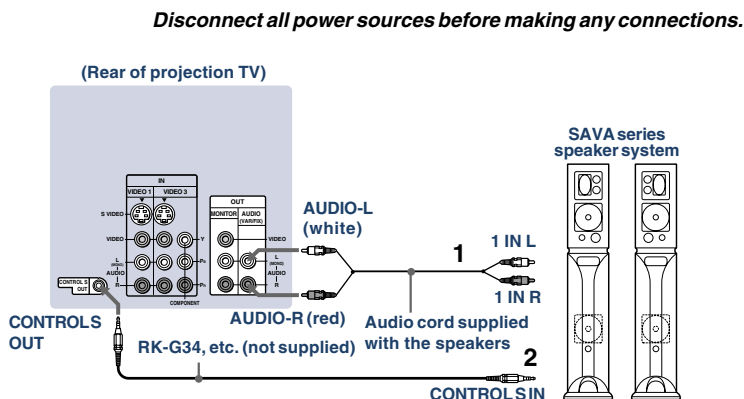

* Manufactured under license from Dolby Laboratories Licensing Corporation. Additionally licensed under Canadian patent number 1,037,877. "Dolby," the double-D symbol and "Pro Logic" are trademarks of Dolby Laboratories Licensing Corporation.

Basic Set Up

Using the Remote Control

Inserting the batteries

Insert two size AA (R6) batteries (supplied) by matching the + and - on the batteries to the diagram inside the remote control's battery compartment.

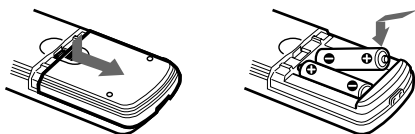

Notes:

- Remove the batteries to avoid damage from possible battery leakage whenever you anticipate that the remote control will not be used for an extended period.
- Handle the remote control with care. Avoid dropping it, getting it wet, or placing it in direct sunlight, near a heater or where the humidity is high.
- Your remote control can be programmed to operate most video equipment. (see "Operating Video Equipment" on page 47)

Setting Up the Projection TV Automatically

The AUTO SET UP feature will allow you to set the on-screen language and set all receivable channels.

The AUTO SET UP feature does not apply for installations that use a cable box for all channel selection.

You can also set up the projection TV manually. (see "Using the Channel Set Up menu" on pages 30 and 31)

Notes:

- Before you perform AUTO SET UP again, make sure that the input from ANT (not AUX) is selected by pressing ANT until "AUX" does not appear next to the channel number.
- Perform this function during the day, with the antenna and/or cable properly connected, to ensure that all available channels will be broadcasting and receivable.
- When you perform AUTO SET UP, all the settings in the Video, and Audio menus are reset to the factory settings.

Using the buttons on the front panel of the projection TV:

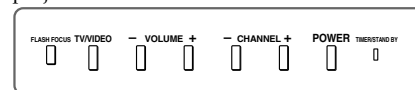

- 1 Press POWER to turn on the projection TV. The AUTO SET UP screen appears.

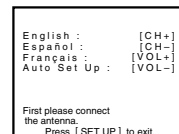
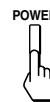

- 2 Press CHANNEL + to select English, CHANNEL - to select Español or VOLUME + to select Français. The screen will change to reflect your choice.

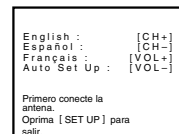
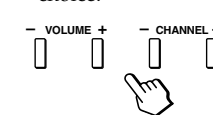

3 Press VOLUME – to continue.

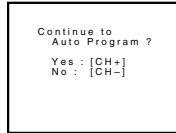
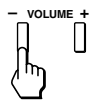

4 Press CHANNEL + to preset channels automatically.

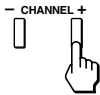

“Auto Program” appears and the projection TV starts scanning and presetting channels automatically. While scanning, the received channel will be displayed on the sub screen. When all the receivable channels are stored, the lowest numbered channel is displayed.

To perform AUTO SET UP again

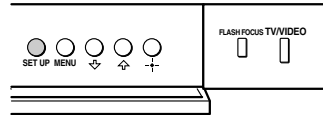

Press SET UP inside the drop-down panel on the projection TV and perform steps 2-4 above.

Press SET UP again to exit.

Adjusting the Convergence Automatically (FLASH FOCUS)

The projection tube image appears on the screen in three layers (red, green and blue). If they do not converge, the color is poor and the picture blurs.

Before you use your projection TV, be sure to adjust the convergence.

The FLASH FOCUS feature allows you to adjust the convergence automatically.

Tips

- It is recommended to perform FLASH FOCUS about 30 minutes after the projection TV is first turned on.
- You can also perform FLASH FOCUS using the Set Up menu on page 31.

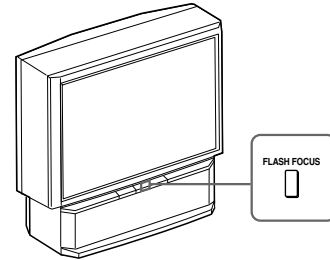

Press FLASH FOCUS.

The cross pattern appears and FLASH FOCUS begins to work. The adjustment is completed when the cross pattern becomes white.

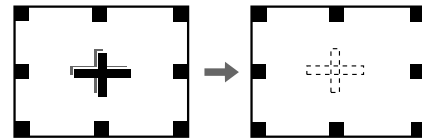

Note:

- FLASH FOCUS is canceled if you perform any other function while FLASH FOCUS is working.

19

Using Your New Projection TV

Watching the TV

Many TV features can be accessed directly through the remote control. The following chart will explain the function of some buttons found on your remote control.

Using the White Labeled Buttons for Projection TV Operations	
TV (FUNCTION)	Activates the remote control for use with the projection TV.
TV POWER	Turns the projection TV on and off. If a video input indication (e.g., VIDEO 1, VIDEO 2) appears on the screen, press TV/VIDEO until a channel number appears.
and ENTER	Use for direct channel selection. Press 0-9 to select a channel (for example, to select channel 10, press 1 and 0). The channel will change after 2 seconds, or you can press ENTER for immediate selection.
CH +/-	Press to scan through the channels (+ up or – down). Speed Surf 1 Press and hold CH + or – to change the channel number rapidly. 2 Release to display the desired channel.
VOL +/-	Press to adjust the volume (+ up or – down).
MUTING	Press to mute the sound. “Muting” will appear on the screen and will dim three seconds later. To restore sound, press again or press VOL +.

PICTURE MODE

Press PICTURE MODE repeatedly to directly choose one of five different video modes that best suits the program you are watching.

Vivid: Select for enhanced picture contrast and sharpness.

Standard: Select to display a standard picture for normal viewing environments.

Movie: Select to display a finely detailed picture for low light environments.

Personal 1, Personal 2: Select to customize the “Picture Adjustment” of the Video menu according to your personal preference.

When you select “Movie,” “Personal 1” and “Personal 2,” you can also perform the “Picture Adjustment” (such as “Brightness,” “Color,” etc.) to suit your taste. For details, see “Mode” on page 26.

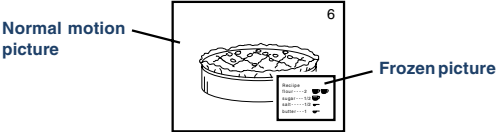
Using the White Labeled Buttons for Projection TV Operations	
TV/VIDEO	Press repeatedly to scroll through available video inputs: TV, VIDEO 1, VIDEO 2 and VIDEO 3. If you select "Skip" as a "Video Label" in the Set Up menu, your projection TV will skip the video input you selected. (see "Video Label" on page 35)
JUMP	Press to alternate or <i>jump</i> back and forth between two channels. The projection TV will jump between the current channel and the last channel selected using the 0-9 buttons.
FREEZE <i>(yellow labeled button)</i>	This is useful when you need to copy down information that appears on the TV's screen. Press to <i>freeze</i> the desired picture. The frozen picture is displayed in the window picture while viewing the normal picture of the current channel in the main picture.  Normal motion picture Frozen picture To change the location of the window picture, press \uparrow , \downarrow , \leftarrow or \rightarrow . Press FREEZE again to display the normal picture.
DISPLAY	Press to display the channel number, current time, channel caption (if set), and MTS/SAP mode (if SAP is selected). The SAP indication disappears and the other indications dim three seconds later. To turn the display off, press DISPLAY again.



(continued)



REFER TO THE ILLUSTRATION OF THE REMOTE CONTROL ON THE INSIDE FRONT COVER OF THIS MANUAL AS YOU REVIEW THIS CHART

21

Using Your New Projection TV (continued)

Using the White Labeled Buttons for Projection TV Operations	
	Press repeatedly to scroll through available displays: XDS (Extended Data Service) Displays a network name, program name, program type, program length, program description, call letters and time of the show if the broadcaster offers this service. Caption Vision Displayed on the screen if the broadcaster offers this service. (see "Caption Vision" on page 34) No display "Off" appears and the display is canceled.
SLEEP	Press repeatedly until the projection TV displays the approximate time in minutes (30, 60, or 90) that you want the projection TV to remain on before shutting off automatically. Cancel by pressing until "Sleep Off" appears.
ANT <i>(AUX input)</i>	Press to change between the VHF/UHF input and the AUX input. (for detailed connection information, see "Cable and antenna" or "Cable box and cable" on page 9)
MTS/SAP	Press to scroll through the Multi-channel TV Sound (MTS) options: Stereo, SAP, Mono and Auto SAP. (see "MTS/SAP" on page 27)
	Press to select an audio option: Simulated, Surround, BBE and Effect Off. (see "Effect" on page 27)
TV/VTR	Press when you are finished using a VCR and you want to switch to the TV input. The VCR power will remain on.
SYSTEM OFF	Press to turn off the projection TV and all other Sony equipment.



REFER TO THE ILLUSTRATION OF THE REMOTE CONTROL ON THE INSIDE FRONT COVER OF THIS MANUAL AS YOU REVIEW THIS CHART

22

Watching Two Programs at One Time — PIP

The Picture-in-Picture (PIP) feature allows you to view two channels simultaneously, one in the full size “main” picture and one in a smaller “window” picture.

You can move the window picture to any location on the screen.

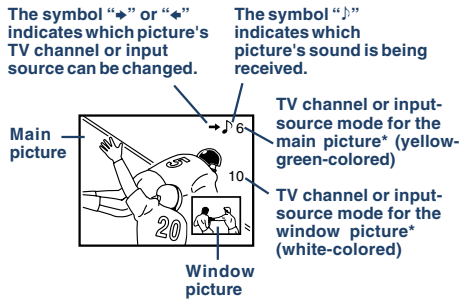

* It will dim in about 3 seconds.

Tip

If you press **RESET** in PIP mode, the window picture will move to the bottom right (factory-preset location).

Using the Yellow Labeled Buttons for PIP Operations

<p>PIP</p>	<p>Press to display a window picture. Each time you press this button, the picture size will change (1/9 → 1/16 → no display). ↑ To close the window picture, press PIP repeatedly until it disappears.</p>
<p>POSITION</p> <p>or</p>	<p>Press POSITION repeatedly to change the location of the window picture (counterclockwise) around the main picture. You can also change the location by pressing the , , or button. The window picture moves in the direction of the arrow indicated on the pressed button.</p>
<p>ACTIVE</p>	<p>Press to select either the main or window picture in order to change the TV channel or video source using the white labeled buttons below. The symbol “+” (or “+”) will appear to indicate which picture’s channel or input mode can be changed.</p>
<p>TV/VIDEO</p> <p>(white labeled button)</p>	<p>Press repeatedly to scroll through the available video inputs for the picture on which the symbol “+” (or “+”) is displayed. (see “TV/VIDEO” on page 21)</p>

23

Using Your New Projection TV (continued)

Using the Yellow Labeled Buttons for PIP Operations	
<p>CH</p> <p>or or and ENTER</p> <p>(white labeled button)</p>	<p>Press to select the TV channel on which the symbol “+” is displayed. (for details, see “Watching the TV” on page 20)</p> <p>Speed Surf</p> <ol style="list-style-type: none"> 1 Press and hold CH + or – to change the channel number rapidly. 2 Release to display the desired channel.
<p>ANT</p> <p>(white labeled button)</p>	<p>Press to change between the VHF/UHF input and the AUX input for the picture on which the symbol “+” (or “+”) is displayed.</p>
<p>AUDIO</p>	<p>Press to alternate sound between the main picture and the window picture. The symbol “j” will appear for a few seconds to indicate which picture’s sound is being received.</p>
<p>FREEZE</p>	<p>This is useful when you need to copy down information of the main picture. Press to freeze the desired scene in the main picture. The frozen picture is displayed in the window picture while viewing the normal picture in the main picture. The window picture size is automatically changed to 1/9 if it was 1/16. Press again to resume normal PIP viewing.</p>
<p>SWAP</p>	<p>Press to switch the audio and video of the main picture and the window picture. Each time you press SWAP, the picture and sound of the two will be exchanged.</p>



REFER TO THE ILLUSTRATION OF THE REMOTE CONTROL ON THE INSIDE FRONT COVER OF THIS MANUAL AS YOU REVIEW THIS CHART

Note:

- If one of the pictures received through PIP is snowy, the entire screen may become unstable. In this case, erase the snowy channel. (see “Channel Skip / Add” on page 31)

24

Adjusting Your SET UP (menus)

Learning Menu Selection

Use the MENU button to access a menu and use the \uparrow , \downarrow , \leftarrow , \rightarrow and \oplus buttons to alter the settings. Use the following example to learn how to modify settings.

- 1 Press the MENU button.

The main menu appears.



- 2 Press \uparrow or \downarrow to highlight the desired menu and press \oplus to activate it.

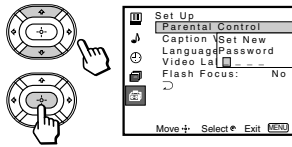

You may also press \rightarrow to activate your selection.

- 3 Press \uparrow or \downarrow to highlight the desired option.

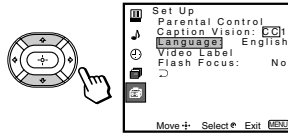

- 4 Press \oplus .

Options for your selection (Pop-up menu or Adjusting menu) will be displayed.

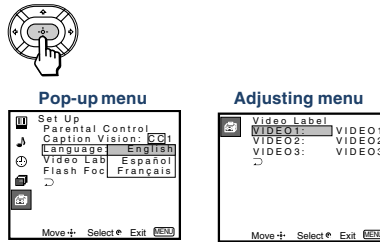

- 5 Press \uparrow or \downarrow to make your selection and press \oplus to activate it. The previous screen will reappear.

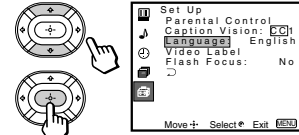

Some adjustment menus may require further operations. For details, see each menu option.

To return to the previous screen (except for the slider adjustment menus), choose " \hookrightarrow " at the bottom of the menu and press \oplus or \leftarrow .

- 6 Once you have completed all menu corrections, press MENU to exit the menu screens.



To exit from the menus at any time

Press MENU.

Tip

You can also use the MENU, \uparrow/\downarrow and \leftarrow/\rightarrow buttons inside the front drop-down panel of the projection TV for the menu selection.

25

Adjusting Your SET UP (menus) (continued)

Using the Video Menu

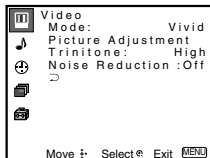

For detailed information on using the remote control to modify menu settings, refer to "Learning Menu Selection" on page 25.

To select the Video menu:

Display \rightarrow Highlight \rightarrow Select

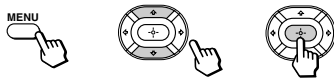

To restore the factory settings

Press RESET on the remote control while the Video menu is selected. To restore each "Mode" to the factory setting, press RESET after selecting the mode to be reset.

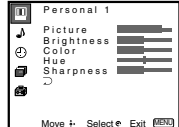
Mode <i>Customized picture viewing</i>	<p>You can choose one of five different video modes that best suits the program you are watching. You can also perform the "Picture Adjustment" (such as "Brightness," "Color," etc.) for "Movie," "Personal 1" or "Personal 2" to suit your taste.</p> <p>Vivid: Select for enhanced picture contrast and sharpness. Standard: Select to display a standard picture for normal viewing environments. Movie: Select to display a finely detailed picture for low light environments. Personal 1, Personal 2: Select to customize the "Picture Adjustment" of the Video menu according to your personal preference. <i>Press PICTURE MODE on the remote control for direct selection of a "Mode" setting.</i></p>
Picture Adjustment <i>Picture adjustment</i>	<p>First select "Movie," "Personal 1" or "Personal 2" from "Mode," then highlight the desired option using the \uparrow or \downarrow button and press \oplus to display the adjusting slider of the selected option.</p> <p>Picture: Adjust slider right (up) to increase picture contrast; left (down) to decrease it. Brightness: Adjust slider right (up) to brighten the picture; left (down) to darken it. Color: Adjust slider right (up) to increase color intensity; left (down) to decrease it. Hue: Adjust slider right (up) to increase the green tones; left (down) to increase the red tones. Sharpness: Adjust slider right (up) to sharpen the picture; left (down) to soften it.</p> 
Trinitone <i>White intensity adjustment</i>	<p>High: Select to give the white colors a blueish tint. Medium: Select to give the white colors a neutral tint. NTSC Standard: Select to give the white colors a reddish tint.</p>
Noise Reduction <i>Noise reduction</i>	<p>Select On to reduce picture noise. Select Off to cancel the feature. <i>"Noise Reduction" can be set separately from the "Mode" settings of the Video menu.</i></p>

26

Using the Audio Menu

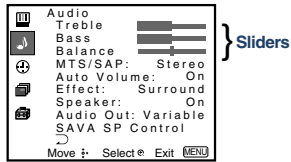

For detailed information on using the remote control to modify menu settings, refer to “Learning Menu Selection” on page 25.

To select the Audio menu:

Display → Highlight → Select

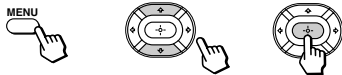

To restore the factory settings

Press RESET on the remote control while the Audio menu is selected.

* The BBE is manufactured by Sony Corporation under license from BBE Sound, Inc. It is covered by U.S. Patent No. 4,638,258 and No. 4,482,866. The word “BBE” and the BBE symbol are the trademarks of BBE Sound, Inc.

Treble <i>Sound adjustment</i>	Adjust slider right (up) to increase high pitched sounds. Adjust slider left (down) to decrease high pitched sounds.
Bass <i>Sound adjustment</i>	Adjust slider right (up) to increase low pitched sounds. Adjust slider left (down) to decrease low pitched sounds.
Balance <i>Sound adjustment</i>	Adjust slider right (up) to emphasize right speaker volume. Adjust slider left (down) to emphasize left speaker volume.
MTS/SAP <i>Enjoy stereo, bilingual and mono programs.</i>	When the sound is intermittent due to poor reception conditions, select “Stereo” or “SAP.” Stereo: Select for stereo reception when viewing a program broadcast in stereo. SAP: Select to listen to a bilingual broadcast. (non-SAP programs will be muted when this feature is selected) Mono: Select for mono reception. (use to reduce noise during stereo broadcasts) Auto SAP: Select to listen to SAP when a SAP program is broadcast and return to stereo reception automatically for non-SAP programs. Quick MTS access: Press on the remote control to cycle through the “MTS/SAP” options as follows: Stereo → SAP → Mono → Auto SAP.
Auto Volume <i>Adjust the sound level.</i>	On: Sound output coming from TV speakers have the volume level equalized for all channel audio inputs when broadcasts have different sound transmission levels. Off: Sound output coming from the TV speakers varies according to the received channel.
Effect <i>Customizes surround sound effects based on the program’s audio type.</i>	“Effect” can only be set when “Speaker” is set to “On” or “Off.” Simulated: Adds a surround-like effect to mono programs. Surround: Simulates sound with the atmosphere of a movie theater or a concert hall for stereo programs. BBE*: Centers the sound intensity to the front, creating an effect as if you were seated in front of an orchestra. Off: Normal stereo or mono reception. Quick Effect access: Press on the remote control to cycle through the “Effect” options as follows: Simulated → Surround → BBE → Effect Off.

(continued) 27

Adjusting Your SET UP (menus) (continued)

Speaker <i>Custom selection of audio output source</i>	On: Select to listen to the sound from the projection TV speakers alone. Off: Select to turn off the projection TV speakers and listen to the projection TV’s sound only through an external audio system’s speakers. SAVA SP: Select to turn off the projection TV speakers and listen to the projection TV’s sound only through the Sony SAVA series speaker system. You can adjust volume, muting, “Surround Mode,” and “Super Woofer Mode” with the projection TV’s remote control. (see “SAVA SP Control” below)
Audio Out <i>Easy control of volume adjustment</i>	“Audio Out” can only be set when “Speaker” is set to “Off.” Fixed: Sound output is held at a fixed level through the audio system. Use the AV receiver’s remote control to adjust the volume. Variable: Sound output varies according to the TV settings. Useful when you want to use your remote control to control the output of a separate audio system.
SAVA SP Control <i>Controls Sony SAVA speaker’s mode.</i>	“SAVA SP Control” can only be set when Sony SAVA speaker system is connected to the AUDIO (VAR/FIX) OUT connectors and “Speaker” is set to “SAVA SP.” (see “Speaker” above) You can also adjust the SAVA speaker’s volume using VOL +/- of the projection TV’s remote control. Surround Mode: Select to activate the SAVA Speaker’s surround mode. Super Woofer Mode: Select to activate the SAVA Speaker’s super woofer mode.

🕒 Using the Timer Menu

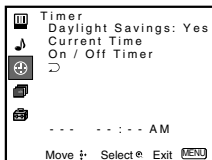

After setting the clock you can use the timer to turn the projection TV on and off.

For detailed information on using the remote control to modify menu settings, refer to “Learning Menu Selection” on page 25.

To select the Timer menu:

Display → Highlight → Select

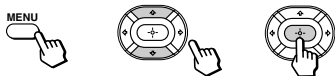

Tip

Set daylight saving time before setting the clock. Any loss of power will cause these settings to be erased.

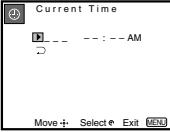
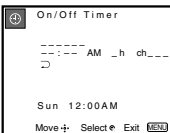
Daylight Savings <i>Automatically adjusts the time.</i>	Spring: Select Yes to compensate for Daylight Saving Time. The current time automatically moves ahead one hour. Fall: Select No at the end of Daylight Saving Time. The current time moves back one hour.
Current Time <i>Necessary for the Timer.</i>	<ol style="list-style-type: none"> 1 Press , then press or until the current day (Sun-Sat) is displayed, and press . 2 Press or until the current hour (1-12) and AM/PM is displayed, and press . 3 Press or until the current minute (00-59) is displayed, and press . The clock has now started. Press MENU to exit. 
On/Off Timer <i>Wake up or scheduled viewing.</i>	<ol style="list-style-type: none"> 1 Press or until the desired day or range of days (Every Sun-Sat, Every Mon-Fri, Sunday, Monday, ... Saturday, Every Sunday, ... Every Saturday) is displayed, and press . 2 Press or until the time (hours and minutes) that you want the projection TV to remain on is displayed, and then press . 3 Press or to set the time duration (maximum of 6 hours) and press . 4 Press or to select the desired channel and press . The timer is now set. The TIMER/STAND BY indicator on your projection TV will be lit. Press MENU to exit. To cancel your timer setting, press RESET while in the On/Off Timer window. Performing Auto Program will erase all Timer settings. 

📺 Adjusting Your SET UP (menus) (continued)

📺 Using the Channel Set Up Menu

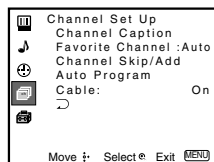

For detailed information on using the remote control to modify menu settings, refer to “Learning Menu Selection” on page 25.

To select the Channel Set Up menu:

Display → Highlight → Select

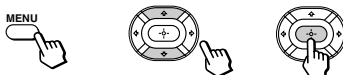

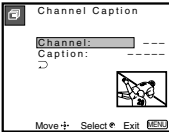
Channel Caption <i>Easy recognition of the channel you are watching</i>	You can add a caption for up to 32 channels of VHF/UHF input. With the Channel Caption window open: <ol style="list-style-type: none"> 1 Press and then press or to select the desired channel. You can view the channel that is selected with the Channel Caption menu in the sub screen. 2 Press . 3 Press or to display the first letter or number of the caption and press to select it. Repeat until up to five digits are selected. 4 Press . <i>To erase a caption, press RESET.</i> 
Favorite Channel <i>User's favorite channels</i>	The Favorite Channel feature enables easy access to the eight channels that you preset (or the last channel that you were watching). (for details on how to set up this feature, see “Setting and Selecting Favorite Channel” on page 32)

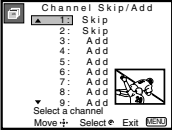
<p>Channel Skip/Add <i>Skips unnecessary channels.</i></p>	<p>After AUTO SET UP, you can erase unnecessary channels from the channel preset memory. With the Channel Skip/Add window open:</p> <ol style="list-style-type: none"> Press ▲ or ▼ to select the desired channel. You can view the channel that is selected with the Channel Skip/Add menu in the sub screen. You can also use CH +/- or 0-9 and ENTER buttons. Press (+). Press ▲ or ▼ to select Skip, and press (+). The selected channel will be erased. If you want to re-enter the skipped channel, follow the steps above and select Add. 	
<p>Auto Program <i>Automatic channel presetting</i></p>	<p>Select Yes to signal the projection TV to automatically program all receivable channels. When all the receivable channels are stored, the lowest numbered channel is displayed. Select No to cancel Auto Program.</p>	
<p>Cable <i>Cable system setting</i></p>	<p>Select On if your projection TV is connected to a cable system. Select Off if your projection TV is connected to an antenna.</p>	

Adjusting Your SET UP (menus) (continued)

Setting and Selecting Favorite Channel

The Favorite Channel feature of your projection TV enables easy access to the eight channels that you preset (or the last channel that you were watching).

Your Favorite Channel options can be set automatically or manually.

The factory setting for "Favorite Channel" is "Auto."

When "Favorite Channel" is set to "Auto," the last eight channels selected with the 0-9 buttons will be set as Favorite Channel options. If you want to input your own selections as Favorite Channel settings, set to "Manual."

Setting Favorite Channel manually

- Select "Favorite Channel" from the Channel Set Up menu. (see page 30)

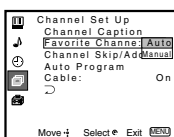

- Press **▲** or **▼** to select "Manual" and press **(+)**.

The Favorite Channel menu will appear. If you set Channel Caption names (e.g. CNN, HBO), they will also be displayed. (see "Channel Caption" on page 30)

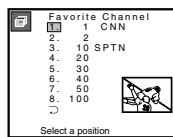
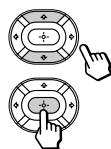

- Press **▲** or **▼** to select a position (1-8), and press **(+)**.

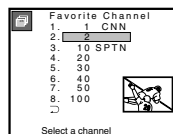
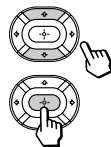

- Press **▲** or **▼** to select a channel and press **(+)**.

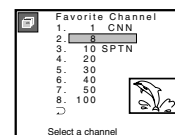
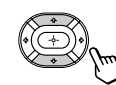

You have now selected a favorite channel.

- Use **▲** and **▼** to program other favorite channels. (Follow steps 3 and 4.)
- Press MENU when you have finished. Your favorite channels are now ready for use.

Changing Favorite Channel choices

You have the option of returning to the Favorite Channel screen to adjust any of your favorite channel choices.

Simply proceed as described in “Setting Favorite Channel manually” (skip step 2 if “Manual” is already selected).

When you reach step 3, select the position you want to change and press **(+)**. Press **▲** or **▼** to select a new channel.

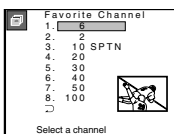

Press MENU when you are done.

Using Favorite Channel

You can use the Favorite Channel feature to directly select the channel you want to watch.

1 Press **(+)** once.

The favorite channel menu and a window picture will be superimposed over the current channel. The window picture displays the channel selected from the menu.

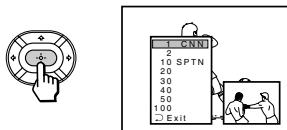

2 Press **▲** or **▼** to select the channel that you wish to view from the menu.

The picture of the selected channel will be displayed in the window picture.

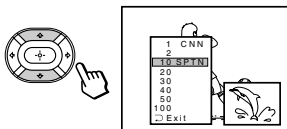

3 Press **(+)** to select the channel.

The selected channel will be displayed for normal viewing.



To cancel the favorite channel menu before selecting a channel, press **▲** or **▼** to select “Exit” at the bottom of the menu and press **(+)**.

Adjusting Your SET UP (menus) (continued)

Using the Set Up Menu

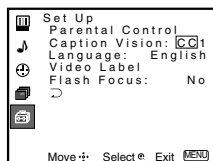

For detailed information on using the remote control to modify menu settings, refer to “Learning Menu Selection” on page 25.

To select the Set Up menu:

Display → Highlight → Select

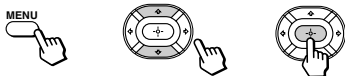

<p>Parental Control <i>Blocks programs unsuitable for children.</i></p>	<p>Allows you to block TV programs that you feel are unsuitable for your children. (see “Using the Parental Control Feature” on page 36 for details)</p>
<p>Caption Vision <i>Television closed caption display</i></p>	<p>Some programs are broadcast with Caption Vision. To display “Caption Vision,” select [CC]1, [CC]2, [CC]3, [CC]4, TEXT1, TEXT2, TEXT3 or TEXT4 from the menu. Then press the [CC] button until “Caption Vision” is displayed. [CC]1, [CC]2, [CC]3 or [CC]4 displays a printed version of the dialogue or sound effects of a program. (The mode should be set to [CC]1 for most programs.) TEXT1, TEXT2, TEXT3, or TEXT4 displays network/station information presented using either half or the whole screen.</p> <p>Notes:</p> <ul style="list-style-type: none"> Poor reception of TV programs can cause errors in Caption Vision and XDS. Captions may appear with a white box or other errors instead of the intended text. XDS, Caption Vision, and the status display cannot be used at the same time.
<p>Language <i>Preferred language</i></p>	<p>Select from available languages (English, Español or Français) to display all menus in your language of choice.</p>

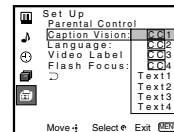

<p>Video Label Easy recognition of connected equipment (e.g. SAT, VHS, etc.)</p>	<p>This feature allows you to label each input mode so that you can easily identify the connected equipment (e.g. you can label VIDEO 1 IN as VHS).</p> <p>With the Video Label window open:</p> <ol style="list-style-type: none"> 1 Press \uparrow or \downarrow to select the input mode you want to label and press (+). 2 Press \uparrow or \downarrow to select the label and press (+). <p>Video Label Options: VIDEO 1: VIDEO 1, VHS, 8mm, Beta, LD, SAT, DVD, AV RECEIVER, DTV, Skip VIDEO 2/3: VIDEO 2/VIDEO 3, VHS, 8mm, Beta, LD, SAT, DVD, DTV, Skip <i>If you select "Skip," your projection TV will skip this connection when you scan through video sources using the TV/VIDEO button.</i></p>
<p>Flash Focus Automatic convergence adjustment</p>	<p>Select Yes and press (+) to start Flash Focus adjustment. When the adjustment is completed, the cross pattern on the screen becomes white. (for details, see page 19) Select No to cancel Flash Focus.</p>

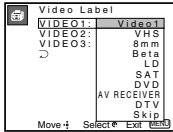
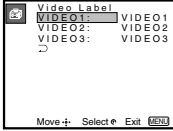

Adjusting Your SET UP (menus) (continued)

Using the Parental Control Feature

The TV programs and movies shown on TV are given a rating signal based on the following rating systems.

In U.S.A.: U.S. Television Parental Guidelines to rate television programs (U.S. TV ratings), and Motion Picture Association of America (MPAA) Guidelines to rate movies including those shown on TV (movie ratings)

In Canada: Canadian English Language ratings to rate television programs in English, and Canadian French Language ratings to rate those in French.

To block programs you feel are unsuitable for your children, you need to set the TV for the desired rating systems. Sony's predetermined ratings are also available.

See pages 43 to 45 for a description of the ratings.

The Parental Control feature of the TV functions by receiving the rating signal from your local broadcasting station or cable service provider.

Activating the Parental Control Feature

First, set a password, then select your desired rating from Sony's predetermined ratings.

- 1 Select "Parental Control" from the Set Up menu. (see page 34)

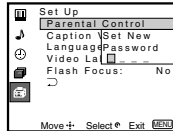

- 2 Enter a four digit password* using the 0-9 buttons.

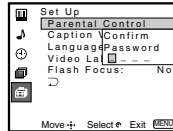

* Do not enter "4357" corresponding to "HELP" on a phone number pad. (see page 43)

- 3 To confirm the password, re-enter the same password with the 0-9 buttons. Your password is stored and the Parental Control menu automatically appears. If you want to change the password, see page 42.

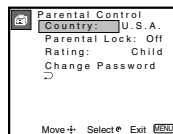

- 4 Make sure that "Country" is highlighted, and press (+).

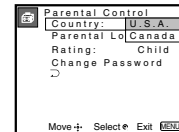

- 5 Press \uparrow or \downarrow to select your country (U.S.A. or Canada), and press (+).

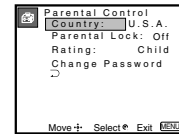

- 6 Press \uparrow or \downarrow to select "Parental Lock," and press (+).

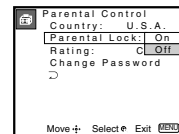

- 7 Press \uparrow or \downarrow to select "On," and press \oplus .

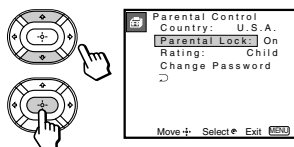

- 8 Press \uparrow or \downarrow to select "Rating," and press \oplus .

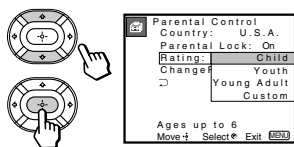

- 9 Press \uparrow or \downarrow to select a desired rating ("Child," "Youth" and "Young Adult"), and press \oplus .

If you want to select the ratings from "Custom," go to step 4 of "Selecting a Custom Rating in U.S.A." on page 38 or "Selecting a Custom Rating in Canada" on page 41, according to your "Country" setting.

- 10 Press MENU to exit the menu.

To deactivate the Parental Control feature

If you set "Parental Lock" in the Parental Control menu to "Off," the Parental Control feature will not work and you can view all TV programs and movies shown on TV.

- 1 Select "Parental Control" from the Set Up menu. (see page 34)

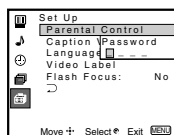

- 2 Enter your four digit password using the 0-9 buttons.

The Parental Control menu appears.

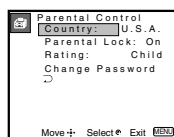

- 3 Press \uparrow or \downarrow to select "Parental Lock," and press \oplus .

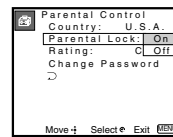

- 4 Press \uparrow or \downarrow to select "Off," and press \oplus .

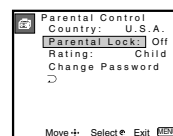

- 5 Press MENU to exit the menu.

Adjusting Your SET UP (menus) (continued)

To unlock the Parental Control feature temporarily

When you select a Parental Control program, no sound or picture except for a channel number will appear. The \square indicator is displayed. To view the program, follow the steps below.

- 1 Press ENTER to display the "Password" screen.
- 2 Enter your password using the 0-9 buttons. Parental Control will be canceled ("Parental Lock" set to "Off") until you turn your projection TV off.

Selecting a Custom Rating in U.S.A.

If you want to select the ratings to be blocked from "Custom" once you have activated the Parental Control feature (page 37), follow the procedure below.

For a detailed description of each rating, see "What the Ratings Mean" on pages 43 to 45.

- 1 Select "Parental Control" from the Set Up menu. (see page 34)

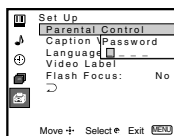

- 2 Enter your four digit password using the 0-9 buttons.

The Parental Control menu appears.

Make sure that "Country" is set to "U.S.A."

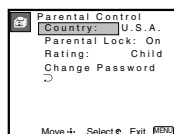

- 3 Press \uparrow or \downarrow to select "Rating," and press \oplus .

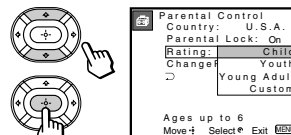

- 4 Press \uparrow or \downarrow to select "Custom," and press \oplus .

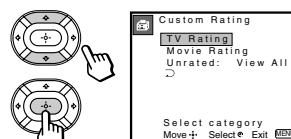

First, select a TV rating.

- 5 Press **▲** or **▼** to select "TV Rating," and press **(+)**.

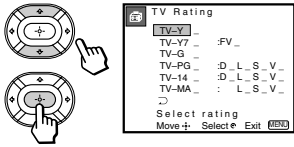

- 6 Press **▲** or **▼** to select the TV rating to be blocked, and press **(+)**.

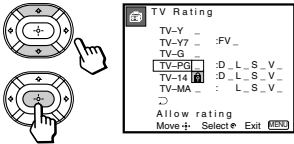

- 7 Press **▲** or **▼** to select "**Ⓜ**," and press **(+)**. The **Ⓜ** indicator automatically appears beside the selected rating and all "higher" ratings, indicating that the programs that match the ratings will be blocked.

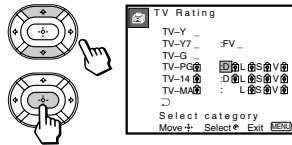

Some ratings have additional content ratings called "extenders." The extenders are defined as follows: D (sexually suggestive Dialog), FV (Fantasy Violence), L (coarse Language), S (Sexual situations) and V (Violence). By setting the extenders, you can define additional viewing limits. For more details of extenders, see page 45.

All of the extenders included in the selected ratings will be blocked. If you wish to allow any of them to be viewed, go to step 8.

- 8 Press **◀** or **▶** to select the extender to be viewed, and press **(+)**.

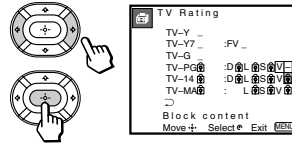

- 9 Press **▲** or **▼** to select "**-**," and press **(+)**. "**-**" appears beside the selected extender, indicating that the programs that match the extender can be viewed.

If you select "**Ⓜ**," **Ⓜ** is displayed to show that the programs that match the extender will be blocked again.

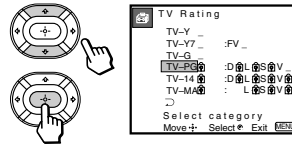

(continued)

39

Adjusting Your SET UP (menus) (continued)

- 10 Repeat steps 8 and 9 for other extenders. All programs that match the ratings you select and higher, except for the extenders that were canceled, will be blocked.

- 11 After setting of the TV rating is complete, press **▲** or **▼** to select "**▷**," and press **(+)**.

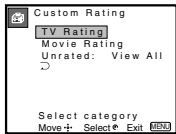

Second, select a movie rating.

- 12 Press **▲** or **▼** to select "Movie Rating," and press **(+)**.

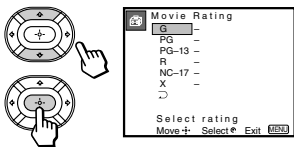

- 13 Press **▲** or **▼** to select the movie rating to be blocked, and press **(+)**.

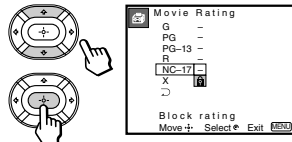

- 14 Press **▲** or **▼** to select "**Ⓜ**," and press **(+)**. The **Ⓜ** indicator automatically appears beside the selected rating and all "higher" ratings, indicating that the programs that match the ratings will be blocked.

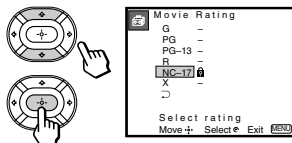

- 15 Press **MENU** to exit the menu.

To block TV programs and/or movies for which a rating signal is not given (NR and N/A)

For a description of the NR and N/A ratings, see page 44.

- 1 Perform steps 1–4 of "Selecting a Custom Rating in U.S.A." on page 38.

- 2 Press **▲** or **▼** to select "Unrated," and press **(+)**.

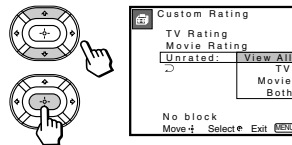

- 3 Press \uparrow or \downarrow to select the type of programs to be blocked, and press \odot .

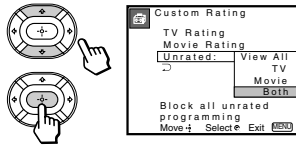

To block ...	Select ...
No program (to view any unrated TV program and movie)	View All
Unrated TV programs	TV
Unrated movies	Movie
Unrated TV programs and movies	Both

- 4 Press MENU to exit the menu.

Selecting a Custom Rating in Canada

If you want to select the ratings to be blocked from “Custom” once you have activated the Parental Control feature (page 37), follow the procedure below.

For a detailed description of each rating, see “What the Ratings Mean” on pages 45 and 46.

- 1 Select “Parental Control” from the Set Up menu. (see page 34)

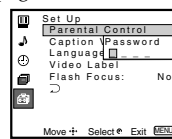

- 2 Enter your four digit password using the 0–9 buttons.

The Parental Control menu appears. Make sure that “Country” is set to “Canada.”

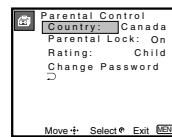

- 3 Press \uparrow or \downarrow to select “Rating,” and press \odot .

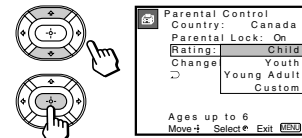

- 4 Press \uparrow or \downarrow to select “Custom,” and press \odot .

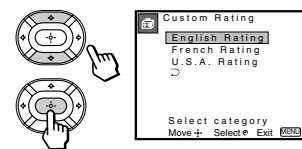

(continued)

Adjusting Your SET UP (menus) (continued)

- 5 Press \uparrow or \downarrow to select the rating you want to block, and press \odot .

The selected rating appears.

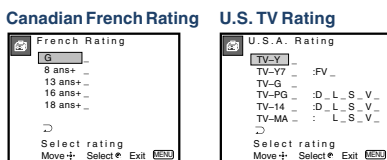
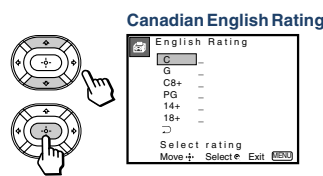

- 7 Press \uparrow or \downarrow to select “ \mathcal{C} ,” and press \odot .

The \mathcal{C} indicator automatically appears beside the selected rating and all “higher” ratings, indicating that the programs that match the ratings will be blocked.

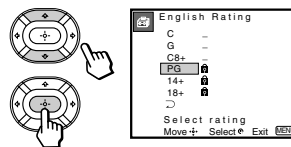

Some U.S. TV ratings have additional content ratings called “extenders,” such as D, FV, L, S and V. By setting the extenders, see steps 7 to 10 of “Selecting a Custom Rating in U.S.A.” on pages 39 and 40. For more details of extenders, see page 45.

All of the extenders included in the selected ratings will be blocked. If you wish to allow any of them to be viewed, go to step 8.

- 8 Press MENU to exit the menu.

- 6 Press \uparrow or \downarrow to select the TV rating to be blocked, and press \odot .

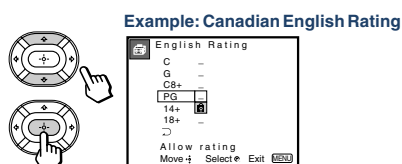

42

Changing the Password

- 1 Select “Parental Control” from the Set Up menu. (see page 34)

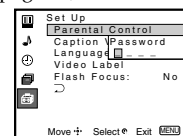

- 2 Enter your four digit password using the 0–9 buttons.

The Parental Control menu appears.

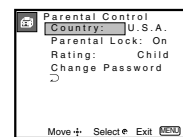

- 3 Press \uparrow or \downarrow to select “Change Password,” and press \odot .

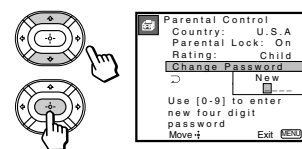

- 4 Enter a new four digit password using the 0–9 buttons.

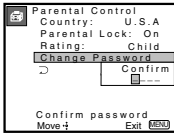

- 5 Enter the password set in step 4 again to confirm.
If you entered it incorrectly, “Password incorrect” appears.
Re-enter the correct password.
- 6 Press MENU to exit the menu.

If you have forgotten your password

In step 2 of “Changing the Password” on page 42, enter the master password “4357” (corresponding to “HELP” on a phone number pad). You can then store a new password.

Notes:

- If you entered “4357” as your password the first time, you cannot store a new password. (see step 2 of “Activating the Parental Control Feature” on page 36)
- When you select a Parental Control program and the indicator is displayed on the screen, you cannot view that program even if you enter “4357.” (see “To unlock the Parental Control feature temporarily” on page 38)

What the Ratings Mean

Ratings in U.S.A.

Sony’s predetermined ratings

These are original ratings that Sony predetermined according to the viewer’s age. Each rating allows you to view the certain programs, as follows.

See pages 44 and 45 for a description of each rating.

Child: Suitable for children under the age of 6.
Viewable U.S. movie ratings: G, NR, and N/A
Viewable U.S. TV ratings: TV-Y, TV-G, and TV-NR

Youth: Suitable for children aged 7 and older.
Viewable U.S. movie ratings: G, PG, NR, and N/A
Viewable U.S. TV ratings: TV-Y, TV-Y7, TV-G, TV-PG, and TV-NR

Young Adult: Suitable for children aged 13 and older.
Viewable U.S. movie ratings: G, PG, PG-13, NR, and N/A
Viewable U.S. TV ratings: TV-Y, TV-Y7, TV-G, TV-PG, TV-14, and TV-NR

(continued)

Adjusting Your SET UP (menus) (continued)

U.S. movie ratings

U.S. movie ratings are for movies (including those shown on TV) rated according to the Motion Picture Association of America (MPAA) Guidelines.

G (General Audiences—All Ages

Admitted): In G-rated films no strong words are used, the violence is at a minimum, nudity and sex scenes are not present, nor is there any drug use.

PG (Parental Guidance Suggested. Some Material May Not Be Suitable For Children):

This is a film which may need to be monitored first by parents.

PG-13 (Parents Strongly Cautioned. Some Material May Be Inappropriate For Children Under 13):

Parents are alerted to be very careful about the attendance of their under-teenage children when viewing.

R (Restricted, Under 17 Require

Accompanying Parent Or Adult Guardian):

This film includes hard language, tough violence, nudity, drug abuse or other elements of concern.

NC-17 or X (No One 17 Or Under Admitted.):

This is a film that most parents would consider not suitable for children aged 17 and under. There may be violence, sex, aberrational behavior, drug abuse or other elements of concern.

NR (Not Rated): This is a film that a producer has not rated, intending to have his film widely released.

N/A (Not Applicable): This is a film that a producer considers outside the scope of the MPAA ratings.

Note:

- NR and N/A ratings are shown together as “Unrated” in the menu.

U.S. TV ratings

U.S. TV ratings are for TV programs rated according to the U.S. Television Parental Guidelines.

TV-Y (All Children): This program is designed for young children aged 2–6 and is appropriate for all children.

TV-Y7 (Directed to Older Children): This program is designed for children aged 7 and above. Themes and elements in this program may include mild fantasy violence or slapstick violence, or may frighten children under the age of 7.

TV-G (General Audience): Most parents would find this program suitable for all ages. It contains little or no violence, no strong language and little or no sexual dialog or situations.

TV-PG (Parental Guidance Suggested):

This program contains some material that parents may find unsuitable for younger children.

TV-14 (Parents Strongly Cautioned): This program contains some material that many parents would find unsuitable for children under the age of 14.

TV-MA (Mature Audience Only): This program is specifically designed to be viewed by adults and therefore may be unsuitable for children under the age of 17.

TV-NR (Not Rated/Unrated): This is a program broadcast without any rating, such as news, news flashes or sports.

Note:

The TV-NR rating is shown as “Unrated” in the menu.

About the extenders of U.S. TV ratings

TV-Y7, TV-PG, TV-14 and TV-MA ratings have additional content ratings called “extenders” to define additional viewing limits. The extenders are defined as follows:

D (sexually suggestive Dialog): Programs containing suggestive dialog, or sexual innuendo

FV (Fantasy Violence): Programs containing cartoon violence occurring in TV-Y7 programs only

L (coarse Language): Programs containing coarse language

S (Sexual situations): Programs containing sexual content

V (Violence): Programs containing violence
There may be some profanity, violence or brief nudity in these programs.

Ratings in Canada

Sony's predetermined ratings

These are original ratings that Sony predetermined according to the viewer's age. Each rating allows you to view the certain programs, as follows.

See the right column and page 46 for a description of each rating.

Child: Suitable for children under the age of 7.

Viewable Canadian English Language ratings: C and G

Viewable Canadian French Language ratings: G

Viewable U.S. TV ratings: TV-Y, TV-G, and TV-NR

Youth: Suitable for children aged 8 and older.

Viewable Canadian English Language ratings: C, G, C8+ and PG

Viewable Canadian French Language ratings: G and 8 ans+

Viewable U.S. TV ratings: TV-Y, TV-Y7, TV-G, TV-PG, and TV-NR

Young Adult: Suitable for children aged 14 and older.

Viewable Canadian English Language ratings: C, G, C8+, PG and 14+

Viewable Canadian French Language ratings: G, 8 ans+, 13 ans+

Viewable U.S. TV ratings: TV-Y, TV-Y7, TV-G, TV-PG, TV-14, and TV-NR

Canadian English Language ratings

The Canadian English Language Ratings are for TV programs in English broadcast in Canada.

C (Programming intended for children under age 8): There will be no realistic scenes of violence or no offensive language, nudity or sexual content. Careful attention is paid to themes, which could threaten children's sense of security and well-being.

G (General Audience): Will contain very little violence, either physical or verbal or emotional. There may be some inoffensive slang, no profanity and no nudity.

(continued)

Adjusting Your SET UP (menus) (continued)

C8+ (Programming generally considered acceptable for children 8 years and over to watch on their own): Violence will not be portrayed as the preferred, acceptable, or only way to resolve conflict; or encourage children to imitate dangerous acts which they may see on television. There will be no profanity, nudity or sexual content.

PG (Parental Guidance): Programming intended for a general audience but which may not be suitable for younger children. Parents may consider some content inappropriate for unsupervised viewing by children aged 8 - 13.

14+ (Programming contains themes or content which may not be suitable for viewers under the age of 14): Parents are strongly cautioned to exercise discretion in permitting viewing by pre-teens and early teens.

18+ (Adult): May contain violence integral to the development of the plot, character or theme, intended for adult audiences. May contain graphic language and explicit portrayals of nudity and/or sex.

E (Exempt): Exempt programming includes: news, sports documentaries and other information programming: talk shows, music videos, and variety programming.

Note:

The E (Exempt) rating is not shown in the menu.

Canadian French Language ratings

The Canadian French Language Ratings are for TV programs in French broadcast in Canada.

G (General): Programming intended for audience of all ages. Contains no violence, or the violence it contains is minimal or is depicted appropriately with humor or caricature or in an unrealistic manner.

8 ans+ (8+ General - Not recommended for young children): Programming intended for a broad audience but contains light or occasional violence that could disturb young children. Viewing with an adult is recommended for young children (under the age of 8).

13 ans+ (Programming may not suitable for children under the age of 13): Viewing with an adult is strongly recommended for children under 13.

16 ans+ (Programming is not suitable for children under the age of 16): Contains frequent scenes of violence or intense violence.

18 ans+ (Programming restricted to adults): Contains constant violence or scenes of extreme violence.

E (Exempt): Exempt programming.

Note:

The E (Exempt) rating is not shown in the menu.

Operating Video Equipment

Setting the Manufacturer's Code

You can use the supplied remote control to operate Sony or non-Sony video equipment that has an infrared sensor.

Press CODE SET, DVD/VTR (FUNCTION), and the 0-9 buttons to enter the manufacturer's code number (see the following chart), then press ENTER.

For example, to operate a Sony 8mm VCR:

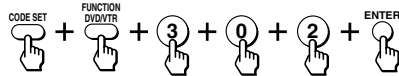

If the remote control doesn't work

- See the tips on page 49.

VCR manufacturer code numbers

Manufacturer	Code
Sony (VHS VCR)	301
Sony (8mm VCR)	302
Sony (Beta, ED Beta, VCRs)	303
Aiwa	338
Admiral (M. Ward)	327
Audio Dynamic	314, 337
Bell & Howell (M. Ward)	330
Broksonic	319, 317
Canon	309, 308
Citizen	332
Craig	302, 332
Curtis Mathis	304, 338, 309
Daewoo	341, 312, 309
DBX	314, 336, 337
Dimensia	304
Emerson	319, 320, 316, 317, 318, 341
Fisher	330, 335
Funai	338
General Electric	329, 304, 309
Go Video	340, 339, 322
Goldstar	332
Hitachi	306, 304, 305, 338
Instant Replay	309, 308
JC Penney	309, 305, 304, 330, 314, 336, 337
JVC	314, 336, 337
Kenwood	314, 336, 332, 337
LXI (Sears)	332, 305, 330, 335, 338
Magnavox	308, 309, 310
Marantz	314, 336, 337
Marta	332
Memorex	309, 335

Minolta	305, 304
Mitsubishi/MGA	323, 324, 325, 326
Multitech	325, 338, 321
NEC	314, 336, 337
Olympic	309, 308
Optimus	327
Panasonic	308, 309, 306, 307
Pentax	305, 304
Philco	308, 309
Philips	308, 309, 310
Pioneer	308
Quasar	308, 309, 306
RCA/PROSCAN	304, 305, 308, 309, 311, 329, 312, 313, 310
Realistic	309, 330, 328, 335, 324, 338
Sansui	314
Samsung	322, 313, 321
Sanyo	330, 335
Scott	312, 313, 321, 335, 323, 324, 325, 326
Sharp	327, 328
Signature 2000 (M. Ward)	338, 327
Sylvania	308, 309, 338, 310
Symphonic	338
SV2000	338
Tashiro	332
Tatung	314, 336, 337
Teac	314, 336, 338, 337
Technics	309, 308
Teknica	338
Toshiba	312, 311
Wards	327, 328, 335, 331, 332
Yamaha	330, 314, 336, 337
Zenith	331

47

Operating Video Equipment (continued)

MDP manufacturer code numbers

Manufacturer	Code
Sony	701
Panasonic	704, 710
Mitsubishi	702

DVD Player manufacturer code numbers

Manufacturer	Code
Sony	751
Panasonic	753
Pioneer	752
RCA	755
Toshiba	754

Tips

- In some rare cases, you may not be able to operate your non-Sony video equipment with the supplied remote control. In this case, please use the equipment's own remote control.
- When you remove the batteries, the code number may revert to the factory setting.

To operate video equipment

- 1 Press DVD/VTR (FUNCTION).
- 2 Use the VCR/DVD/MDP operation buttons indicated in the following tables.

Operating a VCR using the remote control

To turn On/Off	Press DVD/VTR (POWER). [Green Button]
To select a channel	Press the 0 - 9 buttons.
To change channels	Press CH +/-.
To record	Press ▶ while pressing ●.
To play	Press ▶ .
To stop	Press ■ .
To fast forward	Press ▶▶ .
To rewind the tape	Press ◀◀ .
To pause	Press . Press again to resume normal playback.
To search the picture forward or backward	Press ▶▶ or ◀◀ during playback. Release to resume normal playback.
To change input mode	Press TV/VTR.

Operating an MDP using the remote control

To turn On/Off	Press DVD/VTR (POWER). [Green Button]
To play	Press ▶ .
To stop	Press ■ .
To pause	Press . Press again to resume normal playback.

To search the picture forward or backward Press **▶▶** or **◀◀** during playback. Release to resume normal playback.

To search a chapter forward or backward Press CH +/-.

Operating a DVD Player using the remote control

To turn On/Off	Press DVD/VTR (POWER). [Green Button]
To play	Press ▶ .
To stop	Press ■ .
To pause	Press . Press again to resume normal playback.
To step through different tracks of an audio disc	Press ▶▶ to step forward or ◀◀ to step backward.
To step through different chapters of a video disc	Press CH + to step forward or CH - to step backward.
To select tracks directly	Press 0-9 buttons.
To display the menu (Set up)	Press MENU.

48

Operating a Cable Box or Satellite Receiver (SAT)

Setting the Manufacturer's Code

You can program the supplied remote control to operate a cable box or satellite receiver.

Press CODE SET, SAT/CABLE (FUNCTION), and the 0-9 buttons to enter the manufacturer's code number (see the following chart), then press ENTER.

For example, to operate a Sony satellite receiver:

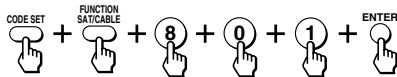

Manufacturer code numbers (cable box)

Manufacturer	Code
Hamlin/Regal	222, 223, 224, 225, 226
Jerrold/G.I	201, 202, 203, 204, 205, 222, 206, 207, 208, 218
Oak	227, 228, 229
Panasonic	219, 220, 221
Pioneer	214, 215
Scientific Atlanta	209, 210, 211
Tocom	216, 217
Zenith	212, 213

Manufacturer code numbers (satellite receiver)

Manufacturer	Code number
Sony	801 (preset code for remote control)
General Electric	802, 808
Hitachi	805
Hughes	804
Panasonic	803
RCA/PROSCAN	802
Toshiba	806, 807

To operate the cable box or satellite receiver (SAT)

- 1 Press SAT/CABLE (POWER) [Green Button] to turn on/off the cable box or satellite receiver.
- 2 Press SAT/CABLE (FUNCTION).
- 3 For other operations, refer to the operating instructions that come with the equipment. The GUIDE and INDEX (blue-labeled) buttons can be used only with a satellite receiver.

If the remote control doesn't work

- Try repeating the set up procedures using the other codes listed for your equipment.

To operate the projection TV

Press TV (FUNCTION). Then use the projection TV control buttons to control the projection TV.

Tips

- If more than one code number is listed, try entering them one by one until you come to the correct code for your equipment.
- If you enter a new code number, the code number you previously entered at that setting is erased.
- In some rare cases, you may not be able to operate your equipment with the supplied remote control. In this case, use the equipment's own remote control unit.
- Whenever you remove the batteries — to replace them, for example — if too much time is taken, the code numbers may revert to the factory setting and must be reset.

49

Troubleshooting

If, after reading the following instructions, you have additional questions related to the use of your Sony projection TV, please call one of the following numbers (English only).

Customers in the continental United States contact the Direct Response Center at: 1-800-222-SONY (7669)

Customers in Canada contact the Customer Relations Center at: (416) 499-SONY (7669)

The picture turns off and the TIMER/STAND BY indicator on the front panel flashes (self-diagnosis function)	<ul style="list-style-type: none"> • The projection TV is equipped with a self-diagnosis function. If there is a problem with your projection TV, the TIMER/STAND BY indicator on the front panel will flash repeatedly. Counting the number of flashes helps you inform qualified Sony personnel of the projection TV's condition. <ol style="list-style-type: none"> 1 Count how many times the TIMER/STAND BY indicator flashes in total. It flashes twice at 3 seconds' intervals. If, for example, the indicator flashes twice, stops flashing for 3 seconds, and flashes twice again, that counts as twice. 2 Press POWER on the projection TV to turn it off, then inform qualified Sony personnel or the above Direct Response Center of the number of flashes.
No picture (screen not lit), no sound	<ul style="list-style-type: none"> • Make sure the power cord is plugged in. • Operate with the buttons on both the projection TV and the remote control. • Check to see if the TV/VIDEO setting is correct: when watching TV, set to TV, and when watching video tapes, set to VIDEO 1, 2, or 3. • Try another channel. <i>It could be station trouble.</i> • Perform AUTO SET UP again using the SET UP button to return to the factory preset condition. (see "To perform AUTO SET UP again" on page 19) • The Parental Control feature is activated. (see "To deactivate the Parental Control feature" on page 37)
Remote control does not operate	<ul style="list-style-type: none"> • Batteries could be weak. Replace the batteries. • Press TV (FUNCTION) when operating your projection TV. • Make sure the projection TV's power cord is connected securely to the wall outlet. • Locate the projection TV at least 3-4 feet away from fluorescent lights. • Check the polarity of the batteries.
Dark, poor or no picture (screen lit), good sound	<ul style="list-style-type: none"> • Adjust "Picture" in the Video menu. (see "Picture Adjustment" on page 26) • Adjust "Brightness" in the Video menu. (see "Picture Adjustment" on page 26) • Check antenna/cable connections. • Perform AUTO SET UP again using the SET UP button to return to the factory preset condition. (see "To perform AUTO SET UP again" on page 19) • Adjust the convergence again using the FLASH FOCUS button. (see "Adjusting the Convergence Automatically (FLASH FOCUS)" on page 19)
Good picture, no sound	<ul style="list-style-type: none"> • Press MUTING so that "Muting" disappears from the screen. (see "MUTING" on page 20) • Check the MTS/SAP setting in the Audio menu. (see "MTS/SAP" on page 27) • Make sure "Speaker" is set to "On" in the Audio menu. (see "Speaker" on page 28) • Perform AUTO SET UP again using the SET UP button to return to the factory preset condition. (see "To perform AUTO SET UP again" on page 19)

50

Cannot receive upper channels (UHF) when using an antenna	<ul style="list-style-type: none"> • Make sure "Cable" is "Off" in the Channel Set Up menu. (see "Cable" on page 31) • Use "Auto Program" to add receivable channels that are not presently in the TV's memory. (see "Auto Program" on page 31)
No color	<ul style="list-style-type: none"> • Adjust "Color" in the Video menu. (see "Picture Adjustment" on page 26) • Black and white programs cannot be seen in color. • Perform AUTO SET UP again using the SET UP button to return to the factory preset condition. (see "To perform AUTO SET UP again" on page 19)
Only snow and noise appear on the screen	<ul style="list-style-type: none"> • Check the "Cable" setting in the Channel Set Up menu. (see "Cable" on page 31) • Check the antenna/cable connections. • Make sure the channel is broadcasting programs. • Press ANT to change the input mode. (see "ANT" on page 22)
Dotted lines or stripes	<ul style="list-style-type: none"> • Adjust the antenna. • Keep the projection TV away from noise sources such as cars, neon signs or hair-dryers.
TV is fixed to one channel	<ul style="list-style-type: none"> • Use "Auto Program" to add receivable channels that are not presently in TV's memory. (see "Auto Program" on page 31)
Double images or ghosts	<ul style="list-style-type: none"> • Use a highly directional outdoor antenna or a cable (when the problem is caused by reflections from nearby mountains or tall buildings).
Cannot operate the menu	<ul style="list-style-type: none"> • If the item you want to choose appears in gray, you cannot select it. • Press the projection TV's power button off and on again.
Cannot receive any channels when using cable TV	<ul style="list-style-type: none"> • Make sure "Cable" is "On" in the Channel Set Up menu. (see "Cable" on page 31) • Use "Auto Program" to add receivable channels that are not presently in the TV's memory. (see "Auto Program" on page 31)
Cannot gain enough volume when using a cable box	<ul style="list-style-type: none"> • Increase the volume at the cable box. Then press TV (FUNCTION) and adjust the projection TV's volume.
Favorite Channel does not display your choices	<ul style="list-style-type: none"> • Verify that "Favorite Channel" is set to "Manual" in the Channel Set Up menu. (see "Setting Favorite Channel manually" on page 32)
Some video sources do not appear when you press TV/VIDEO	<ul style="list-style-type: none"> • Ensure that "Video Label" is not set to "Skip." (see "Video Label" on page 35)
Recording through MONITOR OUT does not function properly when recording in PIP mode	<ul style="list-style-type: none"> • MONITOR OUT will not record both images in PIP. Only the main picture will be recorded. • If you are recording the main picture and you switch to the sound of the sub picture using the AUDIO button, the main picture will be recorded with sound from the other program.
Cannot play shooting games	<ul style="list-style-type: none"> • Some shooting games which involve pointing a light beam at the TV screen with an electronic gun or rifle cannot be used with this projection TV. For details, see the instruction manual supplied with the video game software.

SECTION 2 DISASSEMBLY

2-1. REAR BOARD REMOVAL

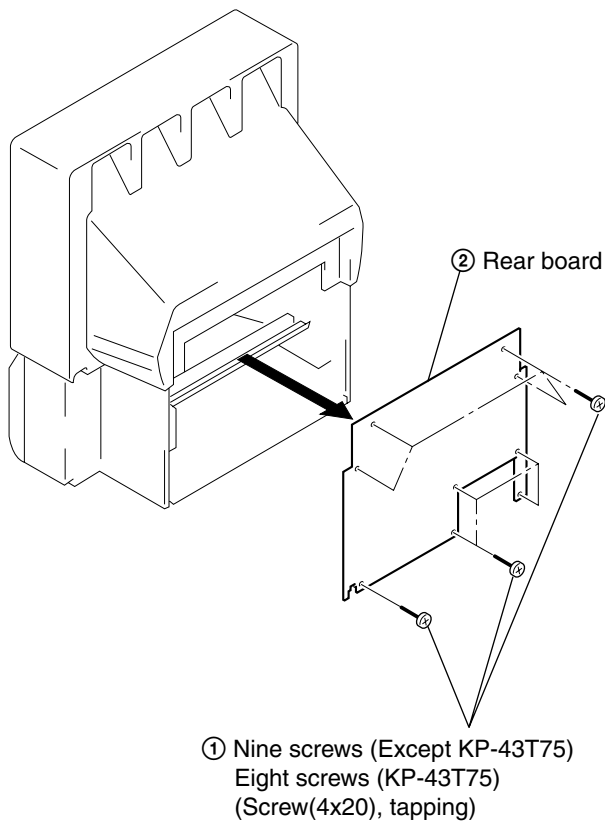

2-2. CHASSIS ASSY REMOVAL

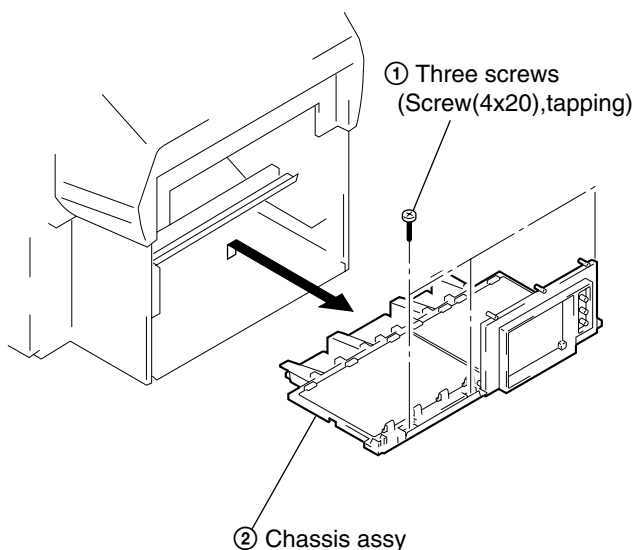

2-3. SERVICE POSITION

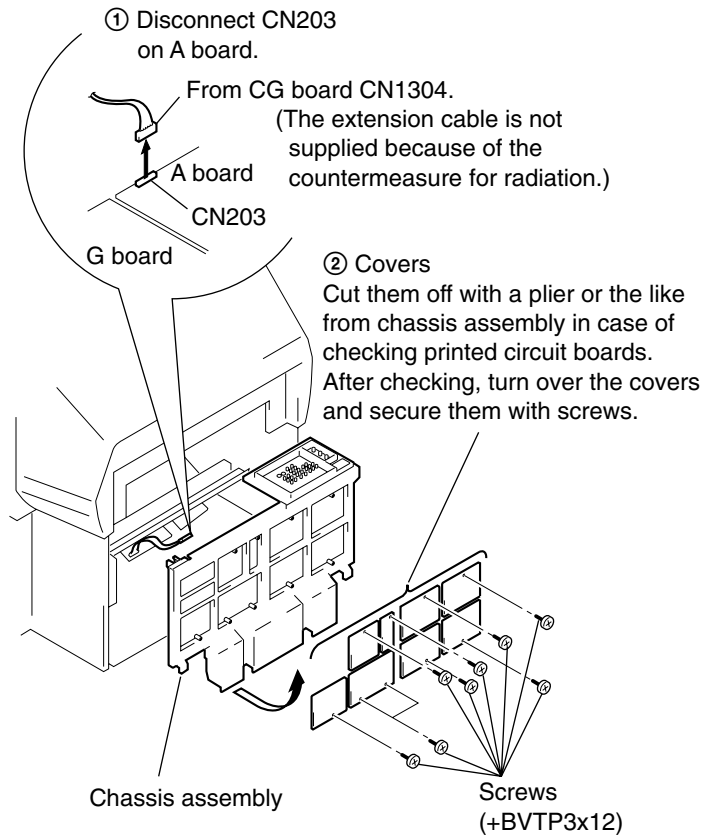

2-4. HA BOARD AND HB BOARD REMOVAL (EXCEPT KP-43T75)

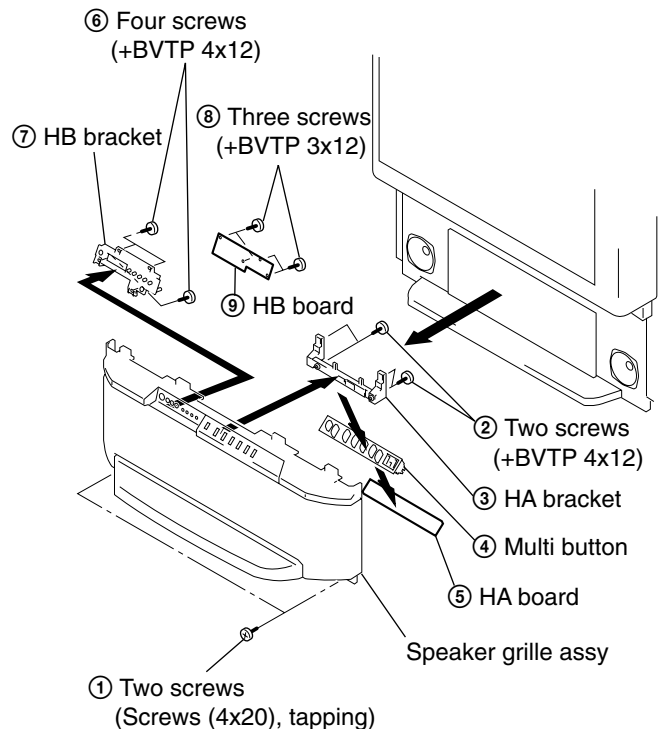

**2-5. HA BOARD AND HB BOARD REMOVAL
(KP-43T75)**

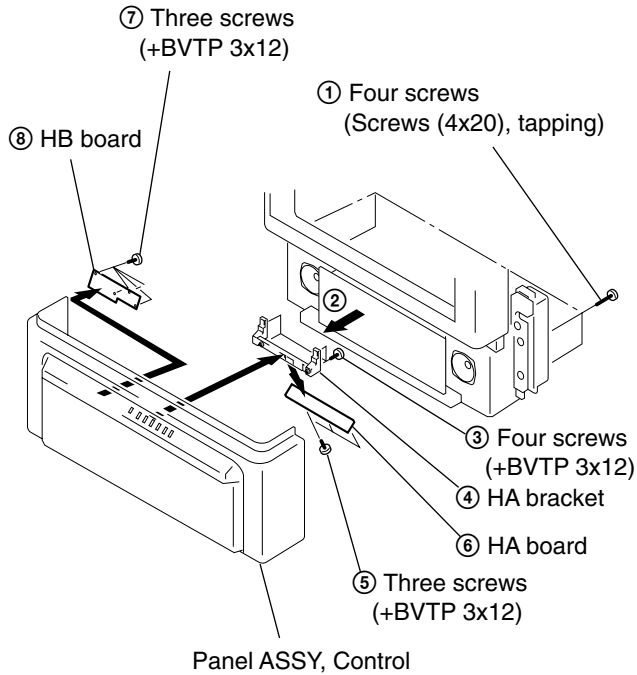

2-6. MIRROR COVER REMOVAL

- ① Seventeen screws (KP-43T75)
- Twenty four screws (KP-48S75)
- Nineteen screws (KP-53N77/53S75)
- Twenty three screws (KP-61S75)
- (Screw(4x20), tapping)

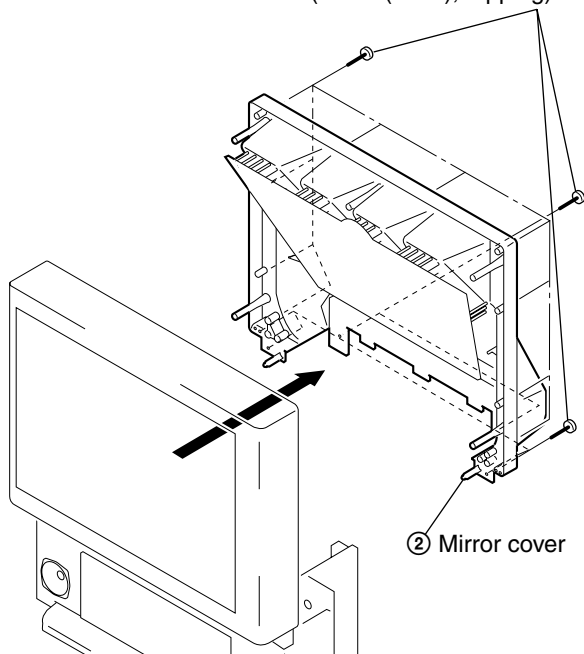

2-7. BEZNET ASSY REMOVAL

- ② Eleven screws (KP-43T75)
- Twelve screws (KP-48S75)
- Fifteen screws (KP-53N77/53S75)
- Fourteen screws (KP-61S75)
- (Screws(4x20), tapping)

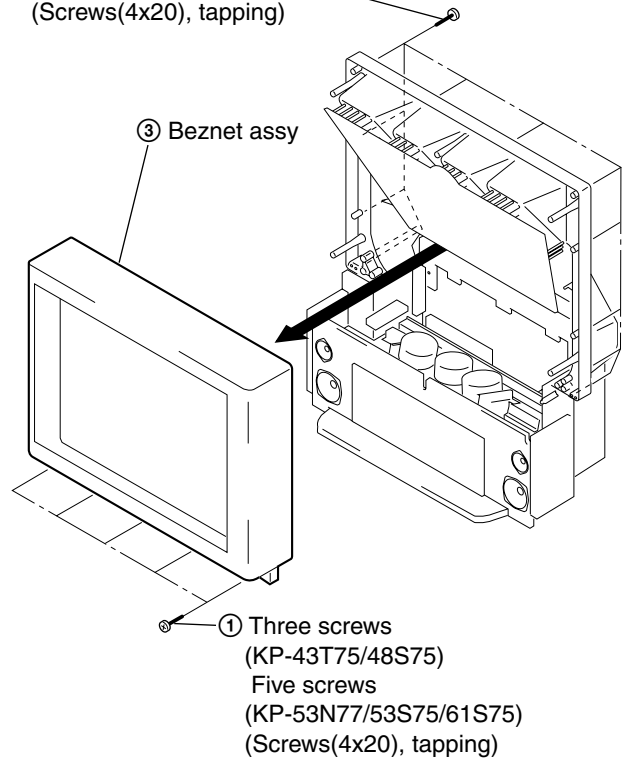

2-8. HC BOARD AND S BOARD REMOVAL

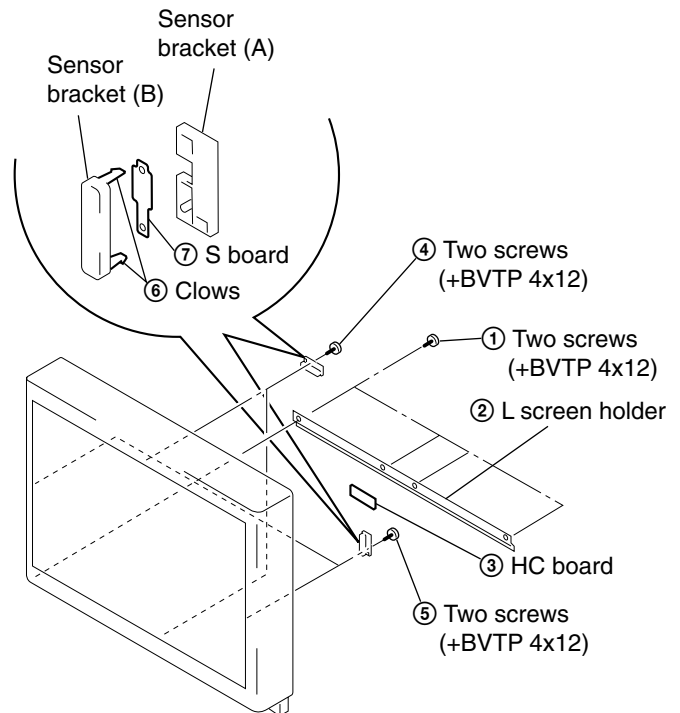

2-9. A BOARD AND G BOARD REMOVAL

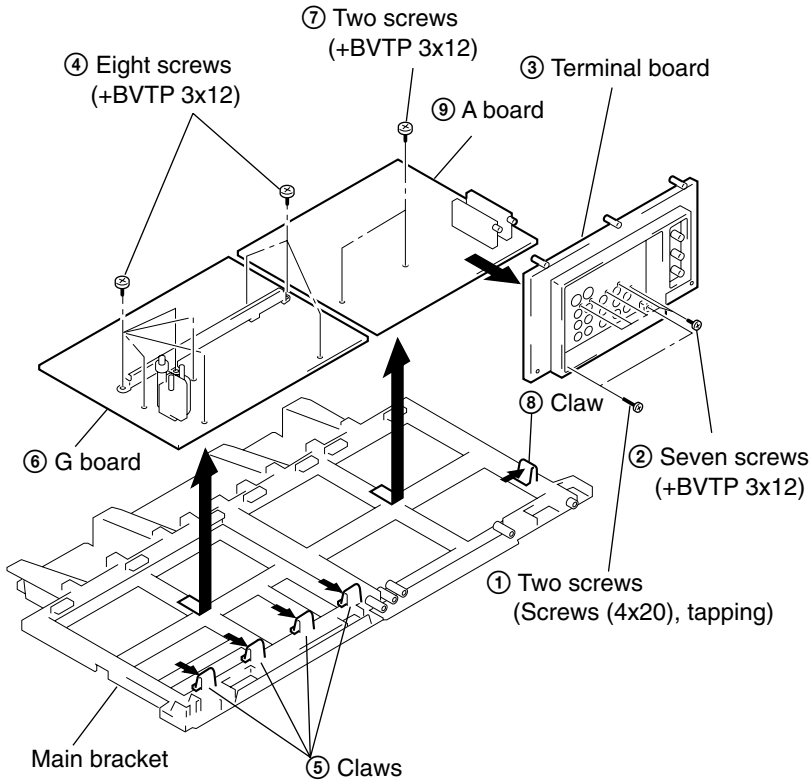

2-10. PICTURE TUBE REMOVAL

CAUTION: Removing the arrow-marked screws is strictly prohibited. If removed, it may cause liquid spill.

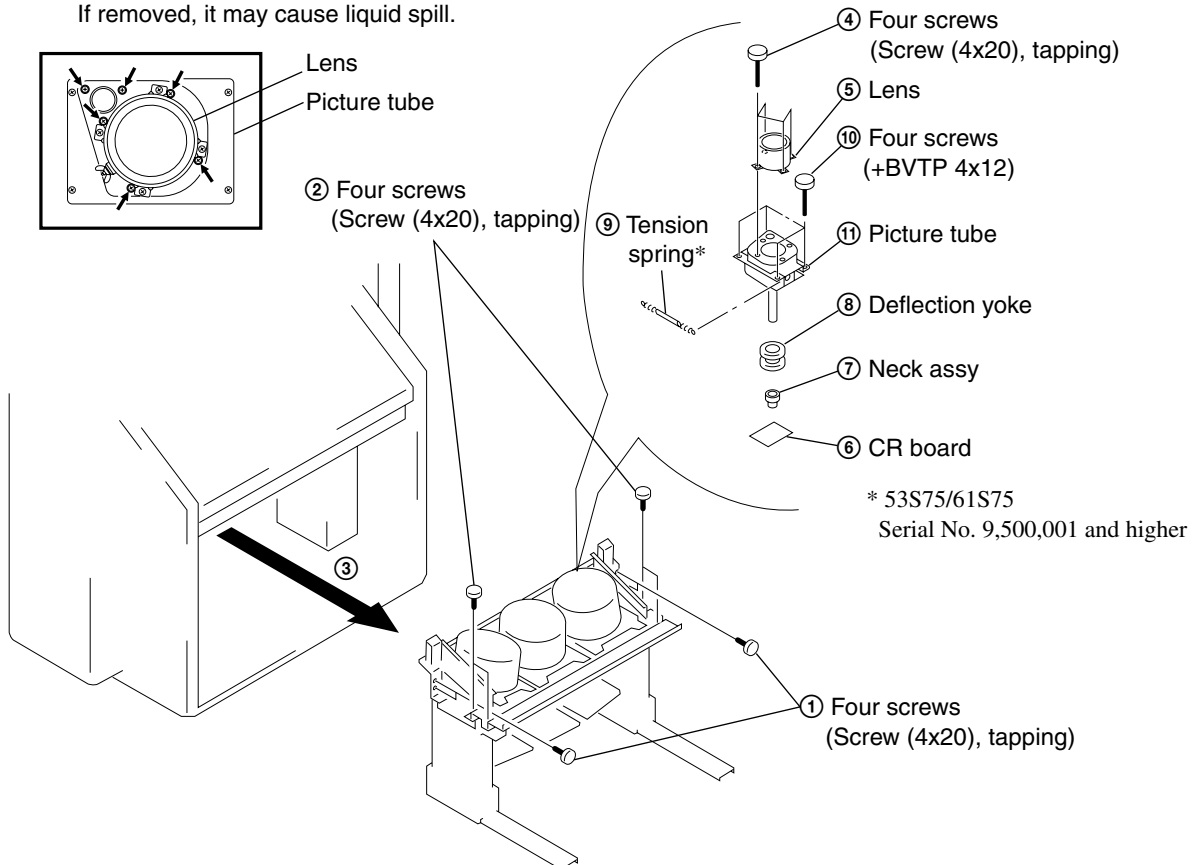

2-11. HIGH-VOLTAGE CABLE INSTALLATION AND REMOVAL

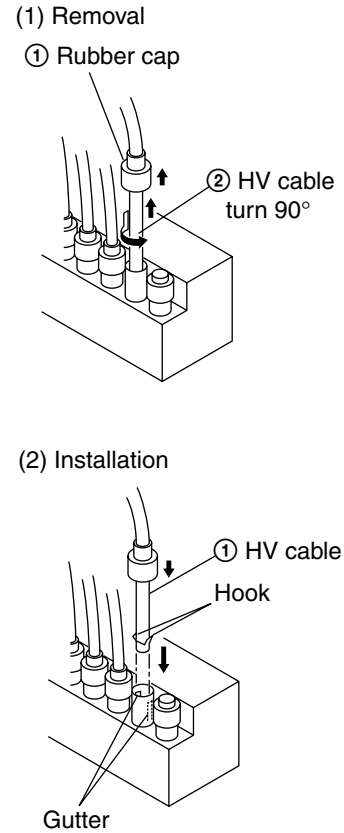

**3-1. SCREEN VOLTAGE ADJUSTMENT
(COARSE ADJUSTMENT)**

1. Receive the Monoscope signal.
2. Set 50% BRIGHTNESS and minimum PICTURE.
3. Turn the red VR on the FOCUS block all the way to the left and then gradually turn it to the right until the point where you can see the retrace line.
4. Next gradually turn it to the left to the position where the retrace line disappears.

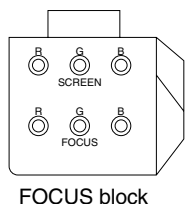

Fig. 3-1

**3-2. SCREEN (G2) ADJUSTMENT
(FINE ADJUSTMENT)**

Fine Mode is recommended to set screen controls to their optimal condition. It is necessary to build the simple jig, illustrated below, using 3-watt resistors. Please note, that if the proper voltage is not obtained with their listed values, resistors, then please increase or decrease one of the values in the resistor network to obtain the correct voltage.

1. Select VIDEO1 mode without signals.
2. Connect G2 JIG.
3. SW on JIG.
4. Connect an oscilloscope to the TP701(KR), TP732(KG) and TP761(KB) of CR board, CG board and CB board.
5. Adjust R, G and B screen voltage to 170-173V with screen VR on the Focus block.

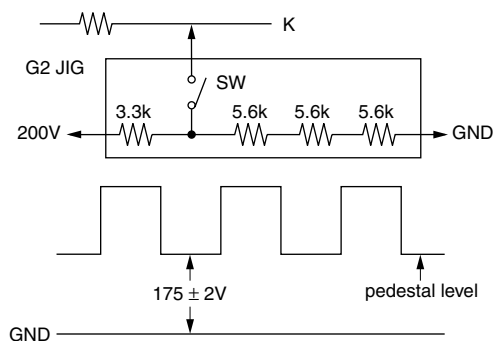

Fig. 3-2

3-3. DEFLECTION YOKE TILT ADJUSTMENT

1. Receive the Monoscope signal.
2. Set in service mode.
3. Cover the both red and blue picture lenses with the lens caps to show only the green color.
4. Loosen the deflection yoke set screw and align the tilt of the Deflection Yoke so that the bars at the center of the monoscope pattern are horizontal.
5. After aligning the deflection yoke, fasten it securely to the funnel-shaped portion (neck) of the CRT.
6. The tilt of the deflection yoke for red is aligned in the mode Cover the both green and blue picture lenses with the lens caps and the tilt of the deflection yoke for blue is aligned with in

the mode Cover the both green and red picture lenses with the lens caps is aligned the same as was done for green.

Note: Instead of items 3 and 6, you can cut off the unnecessary color beams by controlling the service mode VPNT 28 RON, 29 GON, and 30 BON.

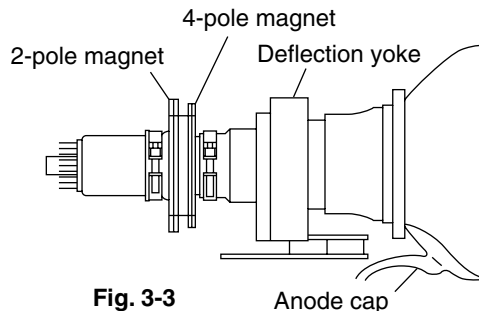

Fig. 3-3

3-4. FOCUS LENS ADJUSTMENT

In this adjustment, use the remote commander in the service mode.

For details of the usage of the service mode and the remote commander, please refer the item 3-9. ELECTRICAL ADJUSTMENT BY REMOTE COMMANDER.

1. Loosen the lens screw.
2. Set to the service mode.
3. Receive the all-white signal.
4. Cover the both red and blue picture lenses with the lens caps to show only the green color.
5. Set to PJE, and press 6 to display the test signal (crosshatch)** on the screen.
6. Turn the green lens to adjust to the optimum focus point with the test signal.
7. Tighten the lens screw.
8. Cover the both green and blue picture lenses with the lens caps to show only the red color.
9. Set to PJE, and press 6 to display the test signal (crosshatch)** on the screen.
10. Adjust red CRT lens just the same as green.
11. Cover the both green and red picture lenses with the lens caps to show only the blue color.

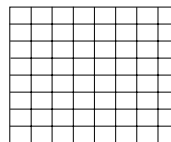

Test signal

Fig. 3-4

12. Set to PJE, and press 6 to display the test signal (crosshatch)** on the screen.
13. Adjust blue CRT lens just the same as green.
14. After adjusting the items 3-5. Focus VR Adjustment, 3-6. 2-Pole Magnet Adjustment and 3-7. 4-Pole Magnet Adjustment, adjust again to the optimum focus point.

*: Every time you press 6, the test signal changes to "crosshatch+video signal" - "dots+video signal" - "crosshatch(black)" - "dots(black)" - off.

Note: Instead of items 4, 8 and 11, you can cut off the unnecessary color beams by controlling the service mode VPNT 28 RON, 29 GON, and 30 BON.

3-5. FOCUS VR ADJUSTMENT

1. Set to the service mode.
2. Receive the all-white signal.
3. Cover the both red and blue picture lenses with the lens caps to show only the green color.
4. Set to PJE, and press 6 to display the test signal (crosshatch) on the screen.
5. Turn the green focus VR on the focus block to adjust to the optimum focus point with the test signal.
6. Cover the both green and blue picture lenses with the lens caps to show only the red color.
7. Set to PJE, and press 6 to display the test signal (crosshatch) on the screen.
8. Turn the red focus VR on the focus block to adjust to the optimum focus point with the test signal.
9. Cover the both green and red picture lenses with the lens caps to show only the blue color.
10. Set to PJE, and press 6 to display the test signal (crosshatch) on the screen.
11. Turn the blue focus VR on the focus block to adjust to the optimum focus point with the test signal.
12. After adjusting the items 3-4. Focus Lens Adjustment, 3-6. 2-Pole Magnet Adjustment and 3-7. 4-Pole Magnet Adjustment, adjust again to the optimum focus point.

Note: Instead of items 3, 6 and 9, you can cut off the unnecessary color beams by controlling the service mode VPNT 28 RON, 29 GON, and 30 BON.

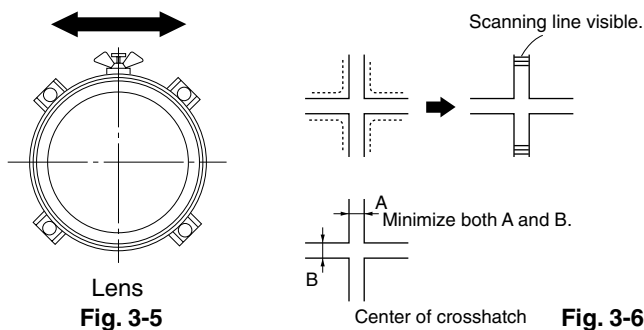

3-6. 2-POLE MAGNET ADJUSTMENT (GREEN, RED)

1. Receive the Dot signal.
2. Set in service mode.
3. Cover the both red and blue picture lenses with the lens caps to show only the green color.
4. Turn the green focus VR on the focus block to the right and set to overfocus to enlarge the spot.
5. Now align the 2-Pole Magnet so that the enlarged spot is in the center of the Just Focus spot.
6. Align the green focus VR and set for just (precise) focus.
7. Perform the same alignment for red.

Use the center dot

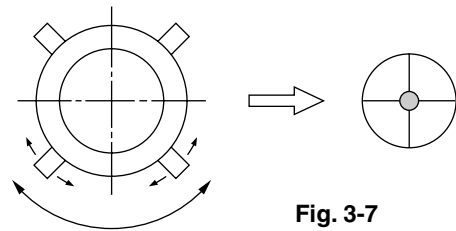

3-7. 4-POLE MAGNET ADJUSTMENT

1. Receive the Dot signal.
2. Set in service mode.
3. Cover the both red and blue picture lenses with the lens caps to show only the green color.
4. Turn the green focus VR on the focus block to the left and set to underfocus to enlarge the spot.
5. Now align the 4-Pole Magnet so that the enlarged spot becomes a perfect circle for green and red.
6. Perform the same alignment for blue.

Use the center dot

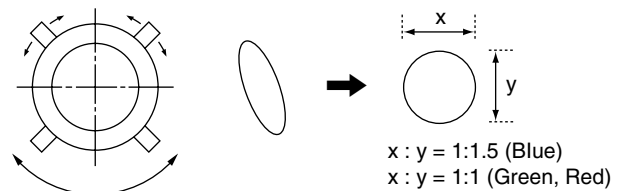

3-8. DEFOCUS ADJUSTMENT (BLUE)

Note: Please adjust the blue dot to be slightly larger than red and green dots. This adjustment provides a more pleasing picture to the customer.

1. Select the video menu and set the mode to "VIVID" mode.
2. Set to the service mode.
3. Change TV mode to the video input mode.
4. Set to PJE, and press 6 to display the test signal (dots) on the screen.
5. Turn the blue focus VR on the focus block to adjust to the diameter of the dots as shown in the figure below.

[Focus adjustment point]

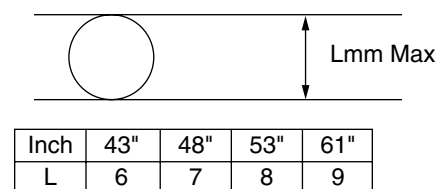

Fig. 3-9

3-9. ELECTRICAL ADJUSTMENT BY REMOTE COMMANDER

By using Remote Commander (RM-Y906), all circuit adjustments can be made.

NOTE : Test Equipment Required.

1. Pattern Generator (with component outputs)
2. Frequency counter
3. Digital multimeter
4. Audio oscillator

1. METHOD OF SETTING THE SERVICE ADJUSTMENT MODE

SERVICE MODE PROCEDURE

1. Standby mode. (Power off)
2. **DISPLAY** → **5** → **VOL (+)** → **TV POWER** on the Remote Commander.
(Press each button within a second.)

SERVICE MODE ADJUSTMENT

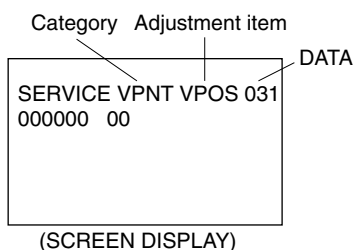

3. The SCREEN displays the item being adjusted.
4. Press **1** or **4** on the Remote Commander to select the adjustment item.
5. Press **3** or **6** on the Remote Commander to change the data.
6. Press **2** or **5** on the Remote Commander to select the category.

Every time you press 2(Category up), Service mode changes in the order as shown below.

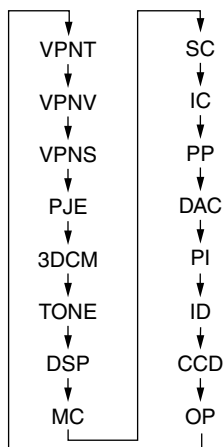

7. If you want to recover the latest values press **0** then **ENTER** to read the memory.
 8. Press **MUTING** then **ENTER** to write into memory.
 9. Turn power off.
- Note: Press **8** then **ENTER** on the Remote Commander to initialize or turn set off and on to exit.

2. MEMORY WRITE CONFIRMATION METHOD

1. After adjustment, remove the plug from AC outlet, and then replace the plug in AC outlet again.
2. Turn the power switch ON and set to Service Mode.
3. Call the adjusted items again and confirm they were adjusted.

3. ADJUSTING BUTTONS AND INDICATOR

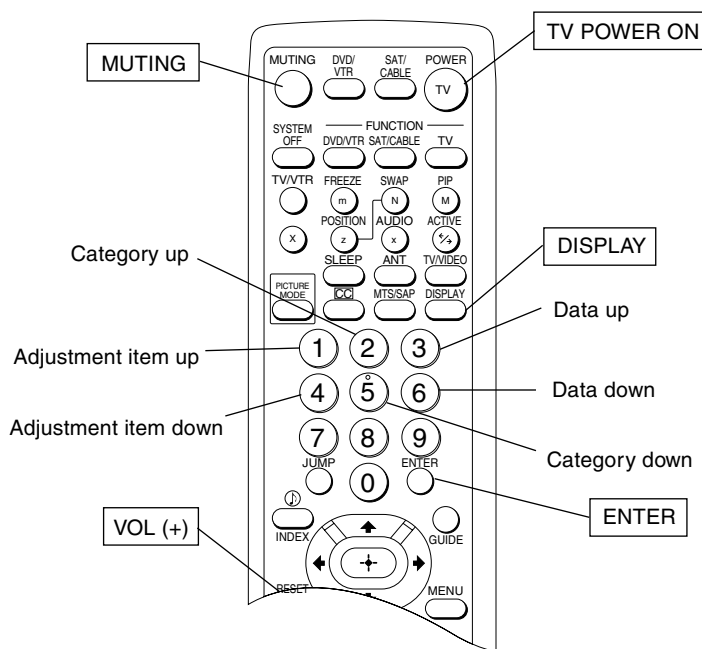

RM-Y906

Note : When the PJE mode is activated, which displays an internally generated signal, several buttons on the remote commander will have different functions than listed above. Therefore, when in the PJE mode, refer to page 43 for button functions.

4. SERVICE MODE LIST

Note: • shaded items are fixed. There is no need to change data. Others are different a little in the sets individually. Basically, there is no need to change data, too.
 • Usually, there is no need to adjust except for VPNT and PJE. Use data as a reference in case of replacing printed circuit boards or devices.

VPNT (Video Processor NTSC)

ITEM NUMBER	ADJUSTMENT ITEM	DATA RANGE	STANDARD DATA	NOTE
0	VPOS	0-63	31	V POSITION
1	VSIZ	0-63	31	V SIZE
2	VCOM	0-3	0	V COMP
3	VLIN	0-15	7	V LINEARITY
4	VSCO	0-15	7	V SCURVE CORRECTION
5	HPOS	0-15	7	H POSITION
6	HSIZ	0-63	31	H SIZE
7	PAMP	0-63	31	PIN AMP
8	UPIN	0-15	7	UPPER CORNER PIN DISTORTION
9	LPIN	0-15	7	LOWER CORNER PIN DISTORTION
10	PPHA	0-15	5	PIN PHASE
11	AFC	0-3	2	AFC LOOP GAIN
12	VBOW	0-15	7	V BOW
13	VANG	0-15	7	V ANGLE
14	REF	0-3	3	REFERENCE PULSE POSITION
15	RDRV	0-63	31	RED DRIVE GAIN
16	BDRV	0-63	31	BLUE DRIVE GAIN
17	RCUT	0-15	7	RED CUTOFF
18	BCUT	0-15	7	BLUE CUTOFF
19	SCON	0-15	7	SUB CONTRAST
20	SHUE	0-15	7	SUB HUE
21	SCOL	0-15	7	SUB COLOR
22	CDM2	0,1	0	COUNT DOWN MODE2
23	DPHX	0,1	1	DYNAMIC PICTURE
24	NOTC	0,1	0	Y CHROMA TRAP
25	CR0M	0-15	7	CHROMA TRAP F0
26	TOT	0,1	0	CHROMA TOT FILTER
27	SHPF	0-3	3	SHARPNESS F0
28	RON	0,1	1	RED ON
29	GON	0,1	1	GREEN ON
30	BON	0,1	1	BLUE ON
31	DCOL	0,1	1	DYNAMIC COLOR
32	CDMD	0,1	0	V COUNT DOWN
33	LBLK	0-15	13	LEFT-SIDE BLANK WIDTH
34	RBLK	0-15	13	RIGHT-SIDE BLANK WIDTH
35	PREK	0-3	1	PRE OVER LEVEL FOR COMP .V IN
36	PREY	0-3	1	PRE OVER LEVEL FOR Y IN

VPNV (Video Processor NTSC Vivid)

ITEM NUMBER	ADJUSTMENT ITEM	DATA RANGE	STANDARD DATA	NOTE
0	SBRV	0-63	27	SUB BRIGHTNESS FOR VIVID
1	GMMV	0-3	2	GAMMA LEVEL FOR VIVID
2	YDCV	0,1	1	Y-DC TRANSFER RATIO FOR VIVID
3	ABLX	0,1	1	ABL MODE FOR VIVID
4	AXIV	0,1	0	AXIS R-Y,G-Y FOR VIVID

VPNS (Video Processor NTSC Standard)

ITEM NUMBER	ADJUSTMENT ITEM	DATA RANGE	STANDARD DATA	NOTE
0	SBRX	0-63	27	SUB BRIGHTNESS FOR STANDARD
1	GMMX	0-3	2	GAMMA LEVEL FOR STANDARD
2	YDCX	0,1	0	Y-DC TRANSFER RATIO FOR STANDARD
3	ABLX	0,1	1	ABL MODE FOR STANDARD
4	AXIX	0,1	0	AXIS R-Y,G-Y FOR STANDARD

3DCM (3D Comb Filter)

ITEM NUMBER	ADJUSTMENT ITEM	DATA RANGE	STANDARD DATA	NOTE
0	NRMD	0-3	0	NOISE REDUCER MODE
1	DYCO	0-15	2	ΔY CORING LEVEL SETTING
2	DYGA	0-15	10	ΔY GAIN SETTING
3	DCCO	0-15	5	ΔC CORING LEVEL SETTING
4	DCGA	0-15	5	ΔC GAIN SETTING
5	SELD	0.1	1	SELECT ΔY SIGNAL FILTER
6	D2GA	0-7	4	ΔY/C 2nd GAIN SETTING
7	VTRH	0-3	1	VTR HSYNC HYSTERESIS SETTING
8	VTRR	0-3	1	VTR HSYNC REFERENCE SETTING
9	LDSR	0-3	2	LD SIGNAL REFERENCE
10	VAPG	0-7	5	V APERTURE GAIN
11	VAPI	0-31	11	V APERTURE INVERT POINT
12	YPFT	0-3	0	Y PEAKING FILTER TAP
13	YPPG	0-15	9	Y PEAKING FILTER GAIN
14	VIPS	0-3	2	VERTICAL 1-LINE SELECTOR
15	VEGS	0-3	1	VERTICAL EDGE SELECTOR
16	CC3N	0.1	0	C SIGNAL 3-LINE COM FILTER
17	HDP	0-7	4	HD HORIZONTAL PHASE
18	CDL	0-7	4	C DELAY
19	HSSL	0-15	12	H SYNC SLICE LEVEL
20	VSSL	0-15	8	V SYNC SLICE LEVEL
21	HPLF	0.1	1	H PLL FILTER
22	BPLF	0.1	0	BURST PLL FILTER
23	FSCF	0.1	1	FSC FILTER GAIN
24	PLFG	0.1	1	PLL FILTER GAIN
25	EXAD	0.1	1	EXTERNAL AD IN
26	MSS	0.1	0	FORCED MOTION SIGNAL
27	COUT	0-3	2	C SIGNAL OUTPUT
28	YAPS	0-3	1	Y APERTURE
29	NSDS	0-3	0	NON STD SIGNAL DETECT.
30	CPP	0-3	0	CLAMP PULSE & AD RANGE
31	YHCO	0-3	1	Y HIGH FREQ.SIGNAL CORING
32	YPCO	0.1	0	Y PEAK FILTER CORING OFF
33	KILR	0-15	3	KILLER REFERENCE
34	BGPS	0-15	4	BGP START POSITION
35	BGPW	0-15	10	BGP WIDTH
36	ADCL	0-3	2	AD CLOCK DELAY
37	PWRP	0.1	0	PULSE WIDTH REFERENCE
38	YHCG	0.1	0	Y HIGH FREQ.SIGNAL CORING 1/2 GAIN
39	CKG2	0.1	1	CLOCK GENERATOR TEST BIT
40	CKGE	0.1	0	CLOCK GENERATOR TEST BIT

PJE (Projection TV Engine)

ITEM NUMBER	ADJUSTMENT ITEM	DATA RANGE	STANDARD DATA	NOTE
0	FDJS	0.1	0	SELECT REGI DATA DISPLAY OF FINE ADJ
1	OSDH	1-255	31	PJED SERVICE MENU H POSITION
2	OSDV	1-255	25	PJED SERVICE MENU V POSITION
3	FVST	0-255	25	LINE NUMBER OF FINE ADJUST START
4	V1ST	0-255	0	V1 START DATA
5	V1CU	0-255	62	V1 COUNT UP DATA
6	COHP	0-255	0	H-PHASE OF ROUGH ADJ
7	FIHP	0-255	194	H-PHASE OF FINE ADJ
8	TPHP	0-255	62	H-PHASE OF TEST PATTERN
9	DFHP	0-255	225	H-PHASE OF DYNAMIC FOCUS
10	DFHG	-128-127	-80	H-2 GAIN OF DYNAMIC FOCUS
11	DFVG	-128-127	-15	V-2 GAIN OF DYNAMIC FOCUS
12	PWM1	0-255	0	PWM1
13	PWM2	0-255	32	H-PHASE OF AUTO REGI .TEST PATTERN
14	HBLD	0-255	244	H-PHASE OF RETURNED BLUE V LINE
15	HBLW	0-63	23	PULSE WIDTH OF RETURNED BLUE V LINE
16	BLKP	0-255	27	START BLANK PULSE
17	COGV	-128-127	X(*1)	GREEN V CENT OFFSET DATA OF AUTO REGI
18	CORV	-128-127	X(*1)	RED V CENT OFFSET DATA OF AUTO REGI
19	COBV	-128-127	X(*1)	BLUE V CENT OFFSET DATA OF AUTO REGI
20	COGH	-128-127	X(*1)	GREEN H CENT OFFSET DATA OF AUTO REGI
21	CORH	-128-127	X(*1)	RED H CENT OFFSET DATA OF AUTO REGI
22	COBH	-128-127	X(*1)	BLUE H CENT OFFSET DATA OF AUTO REGI
23	SOGV	-128-127	X(*1)	GREEN V SKEW OFFSET DATA OF AUTO REGI
24	SORV	-128-127	X(*1)	RED V SKEW OFFSET DATA OF AUTO REGI
25	SOBV	-128-127	X(*1)	BLUE V SKEW OFFSET DATA OF AUTO REGI
26	SORH	-128-127	X(*1)	GREEN H SKEW OFFSET DATA OF AUTO REGI
27	SOBH	-128-127	X(*1)	RED H SKEW OFFSET DATA OF AUTO REGI
28	SOBH	-128-127	X(*1)	BLUE H SKEW OFFSET DATA OF AUTO REGI
29	ERR	FIXED	0	AUTO REGI ERROR CODE
30	ADTM	0-255	144	TIMING TO GET A/D DATA OF AUTO REGI
31	VUP	1-255	1	AUTO REGI PATTERN UPPER V POSITION
32	VMD	1-255	102	AUTO REGI PATTERN MIDDLE V POSITION
33	VLOW	1-255	212	AUTO REGI PATTERN LOWER V POSITION
34	HPR	1-510	1	AUTO REGI PATTERN H POSITION
	CENT	-512-511	000/000	GREEN H/V CENT
	SKEW	-512-511	000/000	GREEN H/V SKEW
	SIZE	-512-511	-70/-190	GREEN H/V SIZE
GRN	LINE	-512-511	xxxx / xxxx	GREEN H/V LINE
	KEY	-512-511	xxxx / xxxx	GREEN H/V KEY
	PIN	-512-511	xxxx / 271	GREEN H/V PIN
	CENT	-512-511	000/000	BLUE H/V CENT
	SKEW	-512-511	080 / -130	BLUE H/V SKEW
BLU	SIZE	-512-511	-20 / -226	BLUE H/V SIZE
	LINE	-512-511	187 / xxxx	BLUE H/V LINE
	KEY	-512-511	xxxx / -115	BLUE H/V KEY
	PIN	-512-511	xxxx / 198	BLUE H/V PIN
	CENT	-512-511	000/000	RED H/V CENT
	SKEW	-512-511	080 / -130	RED H/V SKEW
RED	SIZE	-512-511	-61 / -206	RED H/V SIZE
	LINE	-512-511	195 / xxxx	RED H/V LINE
	KEY	-512-511	xxxx / 124	RED H/V KEY
	PIN	-512-511	xxxx / 250	RED H/V PIN

* 1 : Set correctly by the automatic registration adjustment.
xxxx : Cannot change.

TONE (Tone Control)

ITEM NUMBER	ADJUSTMENT ITEM	DATA RANGE	STANDARD DATA	NOTE
0	RBAS	0-63	39	RESET VALUE OF USER BASS DATA
1	RTRE	0-63	35	RESET VALUE OF USER TREBLE DATA
2	BBEH	0-15	-	BBE HIGH FREQUENCY
3	BBEL	0-11	-	BBE LOW FREQUENCY
4	SUFE	7	-	SURROUND EFFECT

DSP (Digital Signal Processor)

ITEM NUMBER	ADJUSTMENT ITEM	DATA RANGE	STANDARD DATA	NOTE
0	TB0H	0-255	48	TRUSURROUND EFFECT (L+R) COARSE
1	TB0L	0-255	0	TRUSURROUND EFFECT (L+R) FINE
2	TB1H	0-255	64	TRUSURROUND EFFECT (L-R) COARSE
3	TB1L	0-255	0	TRUSURROUND EFFECT (L-R) FINE
4	TB2H	0-255	64	TRUSURROUND EFFECT (C) COARSE
5	TB2L	0-255	0	TRUSURROUND EFFECT (C) FINE
6	TBFH	0-255	165	TRUSURROUND EFFECT (S) COARSE
7	TBFL	0-255	126	TRUSURROUND EFFECT (S) FINE
8	TC0H	0-255	90	TRUSURROUND EFFECT (S) COARSE
9	TC0L	0-255	130	TRUSURROUND EFFECT (S) FINE
10	TC1H	0-255	11	TRUSURROUND EFFECT (L,R) COARSE
11	TC1L	0-255	100	TRUSURROUND EFFECT (L,R) FINE
12	SADH	0-255	64	SRS SPACE LEVEL COARSE
13	SADL	0-255	0	SRS SPACE LEVEL FINE
14	SB0H	0-255	92	SRS CENTER LEVEL COARSE
15	SB0L	0-255	0	SRS CENTER LEVEL FINE

MC (Main Chroma Decoder)

ITEM NUMBER	ADJUSTMENT ITEM	DATA RANGE	STANDARD DATA	NOTE
0	MYDR	0-31	22	MAIN Y DRIVE
1	MSHU	0-63	31	MAIN SUB HUE
2	MSCU	0-63	31	MAIN SUB COLOR
3	MUPD	0-15	7	MAIN U PEDESTAL OFFSET
4	MVPD	0-15	7	MAIN V PEDESTAL OFFSET
5	MDLY	0-3	0	MAIN Y DELAY
6	MU2P	0-15	7	MAIN U2 PEDESTAL OFFSET
7	MV2P	0-15	7	MAIN V2 PEDESTAL OFFSET
8	MY2D	0-31	19	MAIN Y2 DRIVE
9	MU2D	0-31	11	MAIN U2 DRIVE
10	MV2D	0-31	11	MAIN V2 DRIVE
11	MPRE	0-3	3	MAIN PRE-OVER

SC (Sub Chroma Decoder)

ITEM NUMBER	ADJUSTMENT ITEM	DATA RANGE	STANDARD DATA	NOTE
0	SYDR	0-31	28	SUB Y DRIVE
1	SSHU	0-63	31	SUB SUB HUE
2	SSCU	0-63	31	SUB SUB COLOR
3	SUPD	0-15	7	SUB U PEDESTAL OFFSET
4	SVPD	0-15	7	SUB V PEDESTAL OFFSET
5	SDLY	0-3	0	SUB Y DELAY
6	SU2P	0-15	7	SUB U2 PEDESTAL OFFSET
7	SV2P	0-15	7	SUB V2 PEDESTAL OFFSET
8	SY2D	0-3	20	SUB Y2 DRIVE
9	SU2D	0-15	11	SUB U2 DRIVE
10	SV2D	0-15	11	SUB V2 DRIVE
11	SPRE	0-3	3	SUB PRE-OVER

IC (Inset Chroma Decoder)

ITEM NUMBER	ADJUSTMENT ITEM	DATA RANGE	STANDARD DATA	NOTE
0	PCDR	0-15	7	PIP COLOR
1	PHDR	0-15	7	PIP HUE
2	PAFC	0-3	2	PIP AFC LOOP GAIN
3	PTAD	0-15	7	PIP TRAP F0 ADJUSTMENT
4	PTOT	0.1	0	PIP CHROMA TOT FILTER
5	PSCN	0-15	7	PIP SUB CONTRAST
6	PYDC	0-7	0	PIP Y DC TRAN
7	PSHP	0.1	1	PIP SHARPNESS F0
8	PMSK	0.1	0	PIP MACRO VISION MASK

PP (Picture In Picture Vseries Only)

ITEM NUMBER	ADJUSTMENT ITEM	DATA RANGE	STANDARD DATA	NOTE
0	BGHP	0-15	10	PIP H POSITION
1	BGHN	0-15	7	PIP H POSITION FOR NO SIGNAL
2	BGVP	0-15	7	PIP V POSITION
3	6BIT	0.1	1	6BIT(SMART6/SKIP6) MATRIX
4	MAHP	0-15	7	MAIN H ACQUISITION
5	MAVP	0-255	23	MAIN V ACQUISITION
6	SAHP	0-15	7	SUB H ACQUISITION
7	SAVP	0-255	23	SUB V ACQUISITION
8	DECS	0-31	18	SUB DECODER REGISTERS
9	DECM	0-31	18	MAIN DECODER REGISTERS
10	DIS	0-127	66	DISPLAY SETTING
11	BSIZ	0-15	2	BORDER SIZE
12	VPED	0-15	13	V PEDESTAL OFFSET
13	UPED	0-15	13	U PEDESTAL OFFSET

DAC (D/A Converter)

ITEM NUMBER	ADJUSTMENT ITEM	DATA RANGE	STANDARD DATA	NOTE
0	UVSH	0-63	31	YUV SUB HUE
1	UVSC	0-63	31	YUV SUB COLOR

PI (Picture In Picture S Series only)

ITEM NUMBER	ADJUSTMENT ITEM	DATA RANGE	STANDARD DATA	NOTE
0	PIPH	-	-	PIP H POSITION
1	PIPV	-	-	PIP V POSITION
2	PYSD	-	-	PIP SELECT DELAY
3	PYDL	-	-	PIP Y DELAY
4	PHDL	-	-	H-PULSE DELAY
5	PMVD	-	-	MAIN V-PULSE DELAY
6	PIVD	-	-	INSET V-PULSE DELAY
7	PCON	-	-	INSET CONTRAST
8	FRMY	-	-	FRAME Y
9	IPER	-	-	PIP PEDESTAL R-Y
10	IPFB	-	-	PIP PEDESTAL B-Y
11	PCPS	-	-	PIP CLP
12	PCPF	-	-	PIP CLP CYCLES
13	PPLL	-	-	PIP PLL TIME CONSTANT
14	PVNR	-	-	PIP VSP PULSE NOISE REDUCTION

ID (Identification)

ITEM NUMBER	ADJUSTMENT ITEM	DATA RANGE	STANDARD DATA	NOTE
0	AREA	0-3	0	AREA ID
1	SERS	0-3	0	SERIES ID
2	VCHP	0-3	0	V CHIP ID

CCD (Closed Caption Decoder)

ITEM NUMBER	ADJUSTMENT ITEM	DATA RANGE	STANDARD DATA	NOTE
0	CCHP	0-63	39	OSD H POSI FOR INDEX & CC/XDS
1	CCHN	0-63	29	NO FUNCTION

OP (Option)

ITEM NUMBER	ADJUSTMENT ITEM	DATA RANGE	STANDARD DATA	NOTE
0	DISP	0-63	9	OSD H POSITION
1	FW1	0-7	2	FIELD1 WINDOW
2	FW2	0-7	3	FIELD2 WINDOW

3-10. REGISTRATION ADJUSTMENT (PJE)

• FUNCTION OF BUTTONS OF REMOTE COMMANDER FOR PJE MODE.

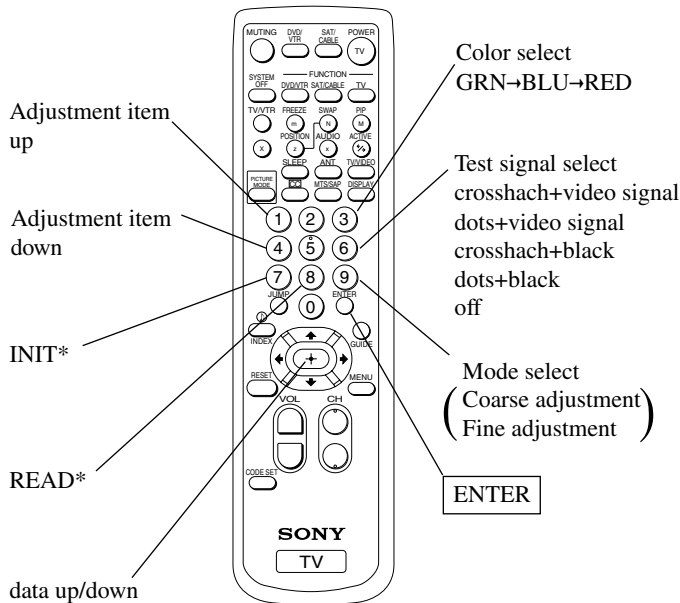

INIT*: Press 7, "INIT" green letters appear on the screen.

Then press ENTER, all the PJE data are reset.

READ*: Press 8, "READ" green letters appear on the screen.

Then press ENTER, all the PJE default data are restored.

Note: Internal patterns are used for geometry and convergence adjustments. However, sizing and centering must be done with the use of an external generator. The recommended pattern would be a monoscope, or equivalent pattern, which would provide the means to adjust both the linearity and sizing of the picture.

[SETUP FOR ADJUSTMENT]

- Current flow in circuit should be stable before attempting adjustment. So wait 5 minutes after turning on the TV power.
- At the 4 insides of the screen, locate the middle. Use a tape measure to identify the middle.

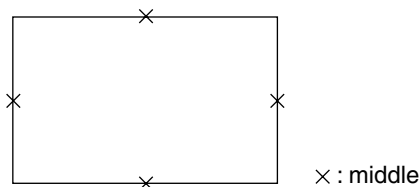

1. Set to the service mode by pressing quickly keys on the remote commander in the standby mode in the following order:

[DISPLAY] → [5] → [VOL+] → [TV POWER]

2. Change TV mode to the video input mode.
3. Change the VPNT mode to the PJE 00 FDIS.

PJE	00	00
FDIS		

4. Set FDIS data to "01" to display the registration data of each spot in the fine adjustment.

PJE	00	01
FDIS		

5. Press [6] to display the test signal (crosshatch) on the screen.
6. Select GRN CENT(*) with the [1] and [4] keys on the remote commander and check that the adjustment data is now "000" both vertically and horizontally.

	(H)	(V)
GRN	000	000
CENT		

- *: In the factory preset, "GRN CENT" appears on the screen first. In case of other colors "RED" or "BLU", change color by every pressing [3] key.

7. Cover the both red and blue picture lenses with the lens caps to show only the green color.

SUB DEFLECTION ADJUSTMENT ITEM

Adjustment O : Yes - : No

Display	Adjustment item	Adjustment type		
		G	R	B
		H/V	H/V	H/V
CENT	CENT	O/O	O/O	O/O
SKEW	SKEW	O/O	O/O	O/O
SIZE	SIZE	-/-	O/O	O/O
LIN	LIN	-/-	O/-	O/-
KEY	KEY	-/-	-/O	-/O
PIN	PIN	-/O	-/O	-/O

[GREEN REGISTRATION ADJUSTMENT]

<GREEN CENTER>

1. Select GRN CENT [1] and [4] keys on the remote commander.
2. Adjust the center of crosshatch line goes the middle vertically and horizontally (GRN CENT) with the joystick on the remote commander.

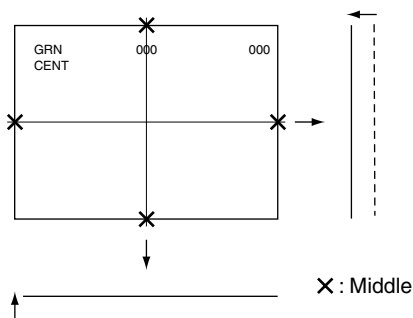

<GREEN SKEW>

1. Select GRN SKEW with the [1] and [4] keys on the remote commander.
2. Adjust the crosshatch line goes straight vertically and horizontally with the joystick on the remote commander.

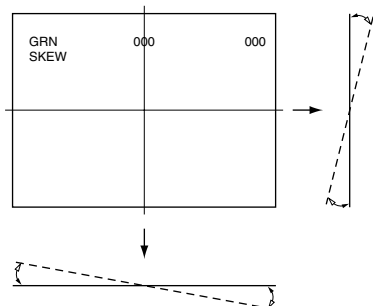

<GREEN PINCUSHION>

1. Select GRN PIN with the [1] and [4] keys on the remote commander.
2. Adjust the crosshatch line goes straight horizontally with the joystick on the remote commander.

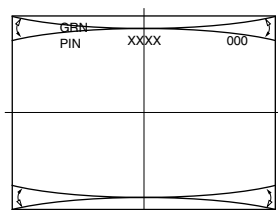

Note : These are required when either severe miss-adjustment or data loss occurred.

<FINE ADJUSTMENT>

1. Press [9] key on the remote commander to shift to the fine adjustment mode.
The green cursor (in the GRN mode) appears on the center of the screen.
2. Use the [1] and [4] keys or the joystick on the remote commander, move the cursor (see below) everywhere you want to adjust and adjust with the joystick keys on the remote commander.

Marker movement by the [1] and [4] keys:

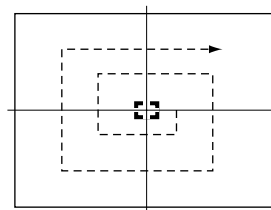

Press once the joystick the cursor turns green to white. Then you can move the cursor up and down left and right everywhere you want.

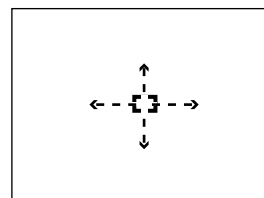

Press once the joystick the cursor stops and returns green, you can adjust around the cursor.

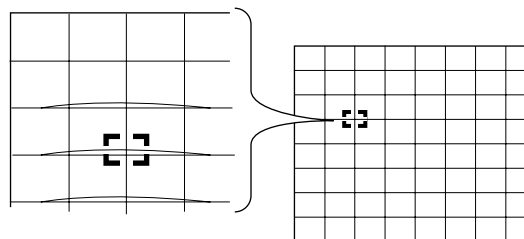

3. Press [9] key on the remote commander to shift to the coarse adjustment mode.

[RED REGISTRATION ADJUSTMENT]

<RED CENTER, SKEW>

1. Cover the blue picture lens with the lens cap to show the green and red colors.
2. Press **[3]** key on the remote commander to shift the GRN mode to the RED mode.
3. Select RED CENT or RED SKEW with the **[1]** and **[4]** keys on the remote commander and adjust while tracking each other alternately.
4. Adjust the red crosshatch lines go straight vertically and horizontally and overlaps the green lines with the joystick on the remote commander.

<RED SIZE, LINEARITY>

1. Select RED SIZE (vertically and horizontally) or RED LIN (vertically) with the **[1]** and **[4]** keys on the remote commander and adjust while tracking each other alternately.
2. Adjust the red crosshatch lines go straight vertically and horizontally and overlaps the green lines with the joystick on the remote commander.

<RED KEY, PINCUSHION>

1. Select RED KEY or PINCUSHION with the **[1]** and **[4]** keys on the remote commander and adjust while tracking each other alternately.
2. Adjust the red crosshatch lines go straight horizontally and overlaps the green lines with the joystick on the remote commander.

Note : These are required when either severe miss-adjustment or data loss occurred.

<FINE ADJUSTMENT>

1. Press **[9]** key on the remote commander to shift to the fine adjustment mode.
The red cursor (in the RED mode) appears on the center of the screen.
2. Use the **[1]** and **[4]** keys or the joystick on the remote commander, move the cursor everywhere you want to adjust and adjust with the joystick on the remote commander.

[BLUE REGISTRATION ADJUSTMENT]

1. Remove the lens cap from the blue picture lens to show full color.
2. Press **[3]** key on the remote commander to shift the RED mode to the BLU mode.
3. Adjust BLU CENT, BLU SKEW, BLU SIZE, BLU LIN, BLU KEY and BLU PIN in the same procedure of the red registration adjustment.

[FINAL CHECK]

1. Store the new adjustment (offset) value on the remote control by pressing **[MUTING]** and **[ENTER]**.
2. Press the FLASH FOCUS button on the front panel.
(The Offset value is now automatically stored.)
3. Check that no error message appears.
If an error message appears, recheck.

Note: In case of replacing CRTs, adjust the set-up adjustments (items 3-1 to 3-8) and the registration adjustment (item 3-10).
In case of replacing two or three CRTs at the same time, replace and adjust one by one.

3-11. AUTO REGISTRATION ERROR CODE LIST

If an error code is displayed after the set has been fully adjusted, correctly, please check the following items: position, tilt and sizing. If either of these adjustments are off, even slightly, the auto-registration pattern will not hit the four sensors properly. This occurs when the internal generator patterns is being flashed on the screen for the sensors to read. Therefore, auto registration (called auto-focus) cannot operate properly causing an error code to be displayed. In order for this function to operate properly, correct position, tilt and size must be adjusted properly.

[ERROR CODE LIST]

ERROR CODE	DISCRIPTION	NOTE
00	No Error	
10	Sensor Output Level Low	* Check wiring, beam position, sensor. 0 : Upper Center 1 : Middle Left 2 : Middle Right 3 : Lower Center
20	Sensor Output Level High	* Check OP-amp circuit. 0 : Upper Center 1 : Middle Left 2 : Middle Right 3 : Lower Center
30	Adjustment Loop Counter Overflow	* Check the registring information on the convergence board.
40	Regi Data Overflow	* Check the convergence yoke driver ICs. * Convergence patterns displayed are out of normal range.
50	Regi Data Overflow	
60	Offset Overflow	
70	Offset Overflow	

* In case of multiple error, last error is displayed.

• ERROR CODE SCREEN DISPLAY

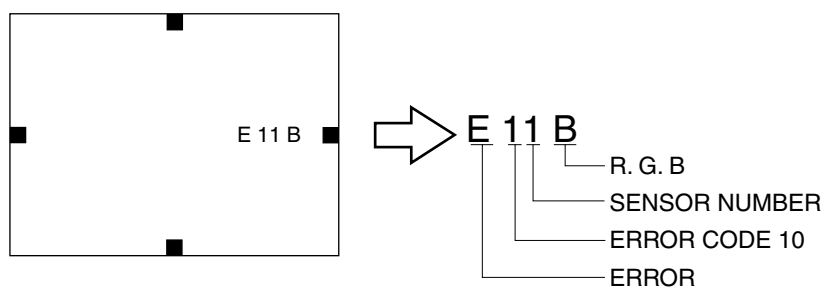

* Error code will be displayed on center of screen for 3 seconds.

[SENSOR POSITION]

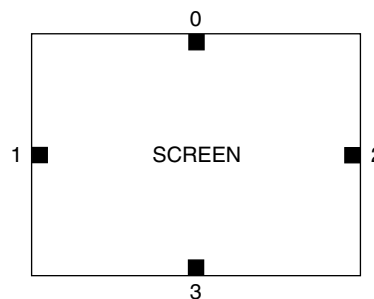

- 0 : UPPER SENSOR
- 1 : LEFT SENSOR
- 2 : RIGHT SENSOR
- 3 : LOWER SENSOR

• ERROR CODE DISPLAY IN REGI SERVICE MODE

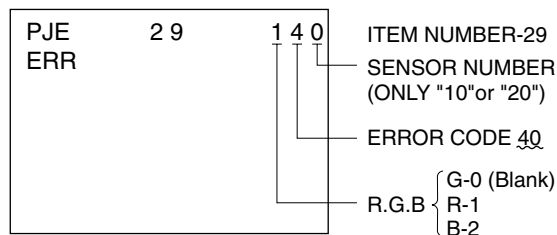

SECTION 4

SAFETY RELATED ADJUSTMENTS

KP-43T75/48S75/
53N77/53S75/61S75
RM-Y906

[G BOARD]

4-1. HV REGULATION CIRCUIT CHECK AND ADJUSTMENT

When replacing the following components marked with \blacksquare on the schematic diagram always check HV regulation, and if necessary re-adjust.

- \boxtimes : C517
- \blacksquare : C517, C521, C522
IC654, L504
T502, T504 (FBT)
D.Y, A board, G board

OPERATION CHECK

1. Connect a HV static voltmeter to the unconnected plug of the high-voltage block. (Fig.4-1)
2. Power on the set.
3. Receive the dot signal. (PICTURE and BRIGHTNESS to minimum)
4. Check that the HV static voltmeter is reading 31.00 ± 1.0 kVdc.

HV Regulation adjustment

1. Connect a HV static voltmeter to the unconnected plug of the high-voltage block.
2. Power on the set.
3. Receive the dot signal. (PICTURE and BRIGHTNESS to minimum)
4. If anode voltage is 31.95kV or higher, replace C517 of 470PF/2kV with that of 1000PF/2kV, and check if the voltage is within the standard range.
5. If anode voltage is 29.45kV or lower, replace C517 of 470PF/2kV with that of 100PF/2kV, and check if the voltage is within the standard range.

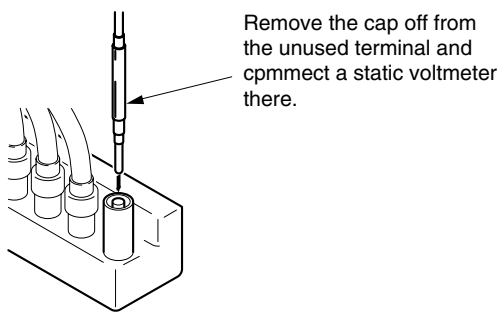

Fig. 4-1

4-2. HV HOLD DOWN CIRCUIT OPERATION CHECK AND ADJUSTMENT

When replacing the following components marked with \blacksquare on the schematic diagram always check hold-down voltage and if necessary re-adjust.

- \boxtimes : R536, R545
- \blacksquare : C516, C536
D506, D507, D522
IC206, IC502, IC654
L504, R511, R522, R536, R538, R545,
R548, R584
T502, T504 (FBT)
D.Y, A board, G board

OPERATION CHECK

1. Remove CN652 connector.
2. Short-circuit across TP-PROT and ground.
3. Connect a HV static voltmeter to the unconnected plug of the high-voltage block.
4. Connect a 220 Ω /200W variable resistor, across pin ② and pin ① of CN652 and connect an external dc power supply unit (200V, class 2A) to pin ③ of CN652.
5. First turn on the external power supply (+B=135V), then turn on the power of the set.
6. Receive the dot signal. (PICTURE and BRIGHTNESS to minimum)
7. Gradually increase the value of the external dc power supply and check that the hold-down circuit operates at a static voltmeter reading of 33.5 ± 1.0 kVdc when the raster disappears.

HV HOLD-DOWN ADJUSTMENT

1. Repeat steps ① ~ ⑦ as above.
2. If hold down voltage is 34.5kV or higher, remove R536, mount a resistor (150k Ω , 1/4W : RN) onto R545 instead, and check again if the hold-down voltage is within the standard range.
3. If hold down voltage is 32.5kV or lower, mount a resistor (220k Ω , 1/4W : RN) onto R536 and check again if the hold-down voltage is within the standard range.

NOTE : Please finish the adjustment as soon as possible

4-3. +B MAX VOLTAGE CONFIRMATION

The following adjustments should always be performed when replacing IC654.

1. Supply 130VAC to with variable autotransformer.
2. Input a dot signal.
3. Set the PICTURE control and the BRIGHTNESS controls to minimum.
4. Confirm the voltage of G BOARD TP135V is less than 137.0Vdc.
5. If step 4 is not satisfied, replace IC654 and repeat above steps.

4-4. +B OVP CONFIRMATION

1. Connect an external dc power supply to TP OVP.
2. Supply 120VAC to variable autotransformer.
3. Set PICTURE and the BRIGHTNESS controls to minimum.
4. Gradually turn the external dc power supply, and check if OVP works properly when the voltage of the external dc power supply is between 139.0 ~ 155.0V.

SECTION 5

CIRCUIT ADJUSTMENTS

5-1. TV INPUT SUB CONTRAST ADJUSTMENT (VPNT-SCON)

1. Receive the color-bar signal.
2. Mode : Personal 1 or 2.
PICTURE : maximum
COLOR : maximum
BRIGHTNESS : center
TRINITONE : medium
SERVICE DATA VPNT SCON : 7
3. Set to service mode.
4. Connect an oscilloscope between pin ⑦ of CN204 (A board) and ground.
5. Select “VPNT-SCON”, and adjust so that the wave from level is $1.80 \pm 0.05V_{p-p}$.
6. Write the data into memory.

MUTING → **ENTER**

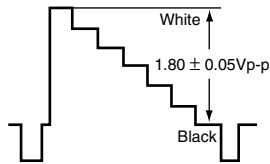

Fig. 5-1

5-2. VIDEO INPUT SUB-HUE AND SUB-COLOR ADJUSTMENT (VPNT-SHUE, SCOL)

1. Select VIDEO1 input and supply the color-bar signal.
2. Mode : Personal 1 or 2.
PICTURE : maximum
COLOR : center
BRIGHTNESS : center
TRINITONE : medium
SERVICE DATA VPNT-SHUE : 7
VPNT-SCOL : 7
3. Set to service mode.
4. Connect an oscilloscope between pin ⑤ of CN204 (A board) connector and ground.
5. Select “VPNT-SHUE, SCOL”, and adjust them to have VB1 = VB4 and VB2 = VB3 in the waveform levels.
6. Increase SCOL by 2 steps.
7. Write the data into memory.

MUTING → **ENTER**

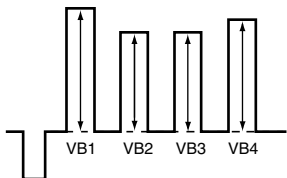

Fig. 5-2

5-3. COMPONENT INPUT SUB-HUE AND SUB-COLOR ADJUSTMENT (DAC-UVSH, UVSC)

1. Select VIDEO 4 and supply the color-bar signal.
VIDEO input
2. Mode : Personal 1 or 2.
PICTURE : maximum
COLOR : center
BRIGHTNESS : center
TRINITONE : medium
SERVICE DATA DAC UVSH : 31
DAC UVSC : 31
3. Set to service mode.
4. Connect an oscilloscope between pin ⑤ of CN204 (A board) connector and ground.
5. Select “DAC-UVSH, UVSC”, and adjust them to have VB1 = VB4 and VB2 = VB3 in the waveform levels.
6. Write the data into memory.

MUTING → **ENTER**

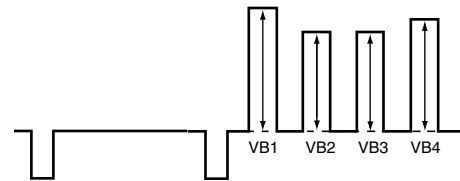

Fig. 5-3

5-4. P & P SUB CONTRAST ADJUSTMENT (SC-SYDR)

1. Receive the signal.
TV terminal (sub) : color-bar signal
VIDEO terminal (main) : no signal
2. Set to service mode and set to P & P mode.
3. Connect an oscilloscope between pin ⑦ of CN204 (A board) and ground.
4. Select “SC-SYDR”, and adjust so that the wave from level is $1.65 \pm 0.05V_{p-p}$.
5. Write the data into memory.

MUTING → **ENTER**

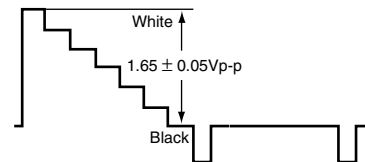

Fig. 5-4

5-5. SUB-HUE , SUB-COLOR AND MAIN CONTRAST ADJUSTMENT (MC-MYDR, MSHU, MSCL, SC-SSHU, SSCL)

1. Receive the color-bar signal.
2. Mode : Personal 1 or 2.
PICTURE : maximum
COLOR : center
BRIGHTNESS : center
TRINITONE : medium
SERVICE DATA MC-MYDR : 22
 MC-MSHU : 31
 MC-MSCL : 31
 SC-SSHU : 31
 SC-SSCL : 31
3. Set to service mode and set to P & P model .
4. Connect an oscilloscope between pin ⑤ of CN204 (A board) connector and ground.
5. Select “ MC-MYDR”, and adjust them to have VB1 = VB5 in the waveform levels.
6. Select “ MC-MSCL, SC-SSCL” and adjust so that the wave form shows VB1=VB4 and VB5=VB8.
7. Select “ MC-MSHU, SC-SSHU” and adjust so that the wave form shows VB2=VB3 and VB6=VB7.
8. Write the data into memory.

MUTING → **ENTER**

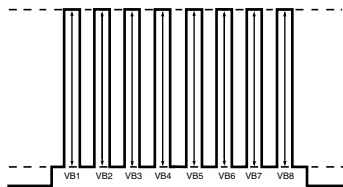
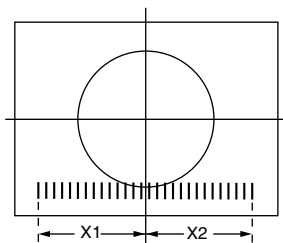

Fig. 5-5

5-6. BAR DISPLAY POSITION ADJUSTMENT (OP-DISP)

1. Receive the monoscope signal.
2. Set to service mode.
3. Push “ PICTURE +” . (Bar is displayed)
4. Select “ OP-DISP ”, and adjust so that the bar is as shown in the figure.
5. Write the data into memory.

MUTING → **ENTER**



$X1 = X2$

Fig. 5-6

5-7. PIP POSITION ADJUSTMENT (PI-PIPH, PIPV)

1. Set the PIP mode.
2. Receive the monoscope signal on the main/sub picture.
3. Check the sub picture position.

$X1-X2 \leq 0.25sq$

$X1-X2 \leq 0.25sq$

4. If necessary set to service mode and adjust "PIPH", "PIPV".
5. Write the data into memory.

MUTING → **ENTER**

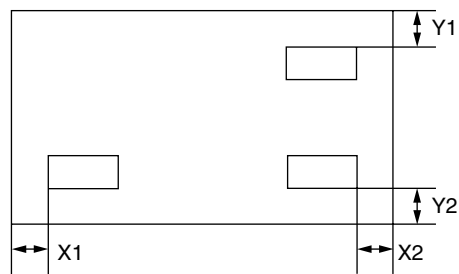
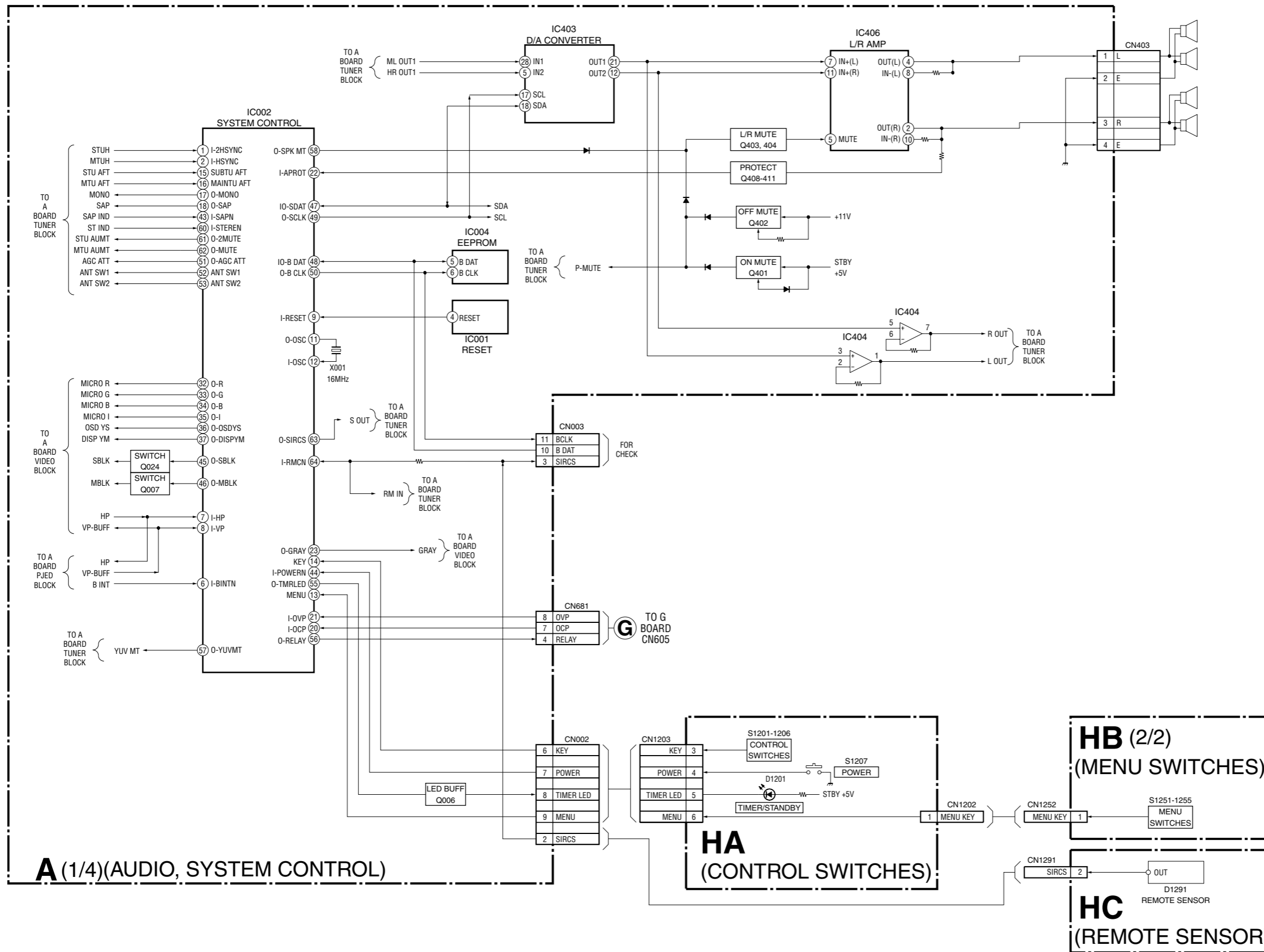

Fig. 5-7

**SECTION 6
DIAGRAMS**

6-1. BLOCK DIAGRAM (1)



BLOCK DIAGRAM (2)

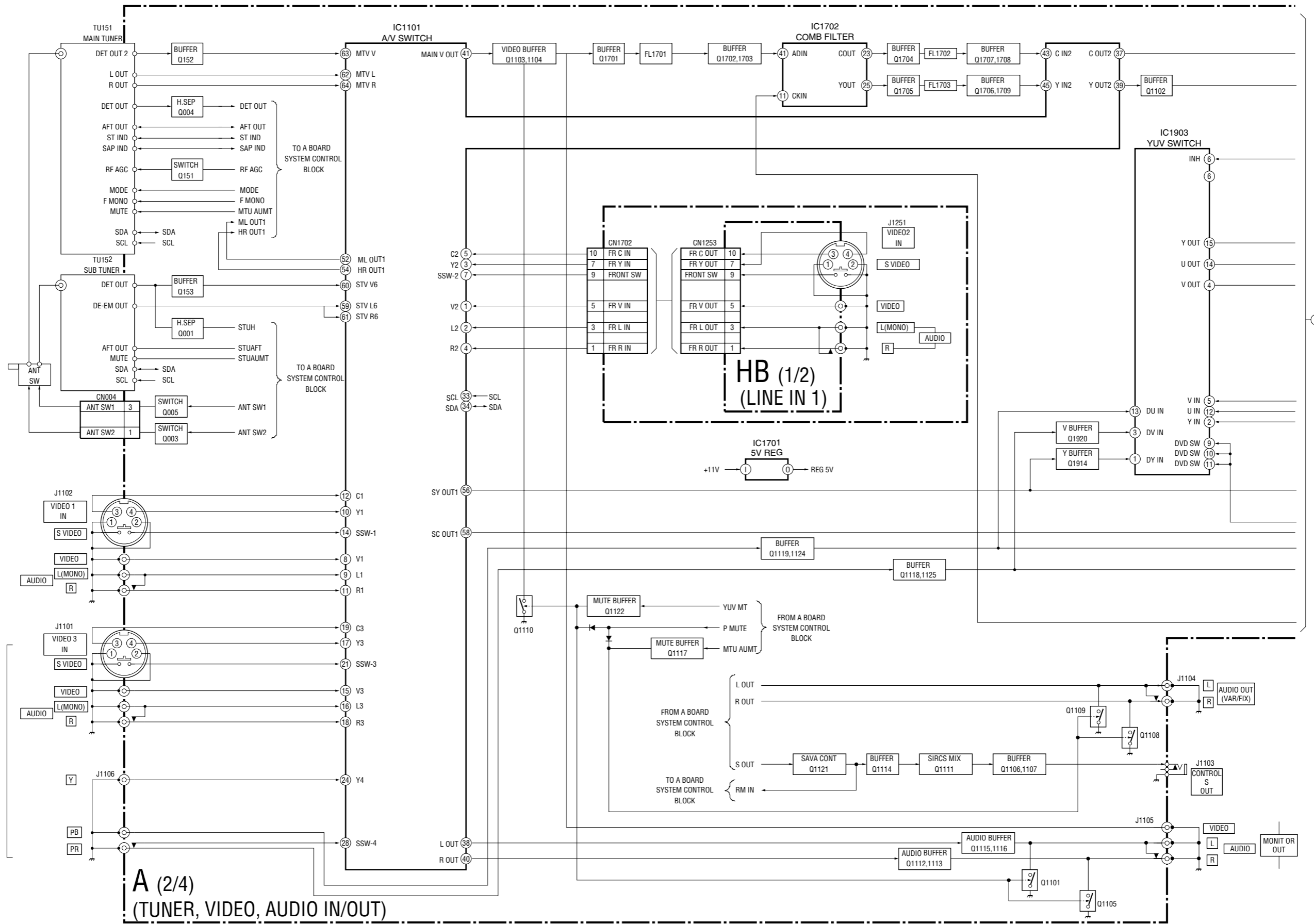

A (2/4)
(TUNER, VIDEO, AUDIO IN/OUT)

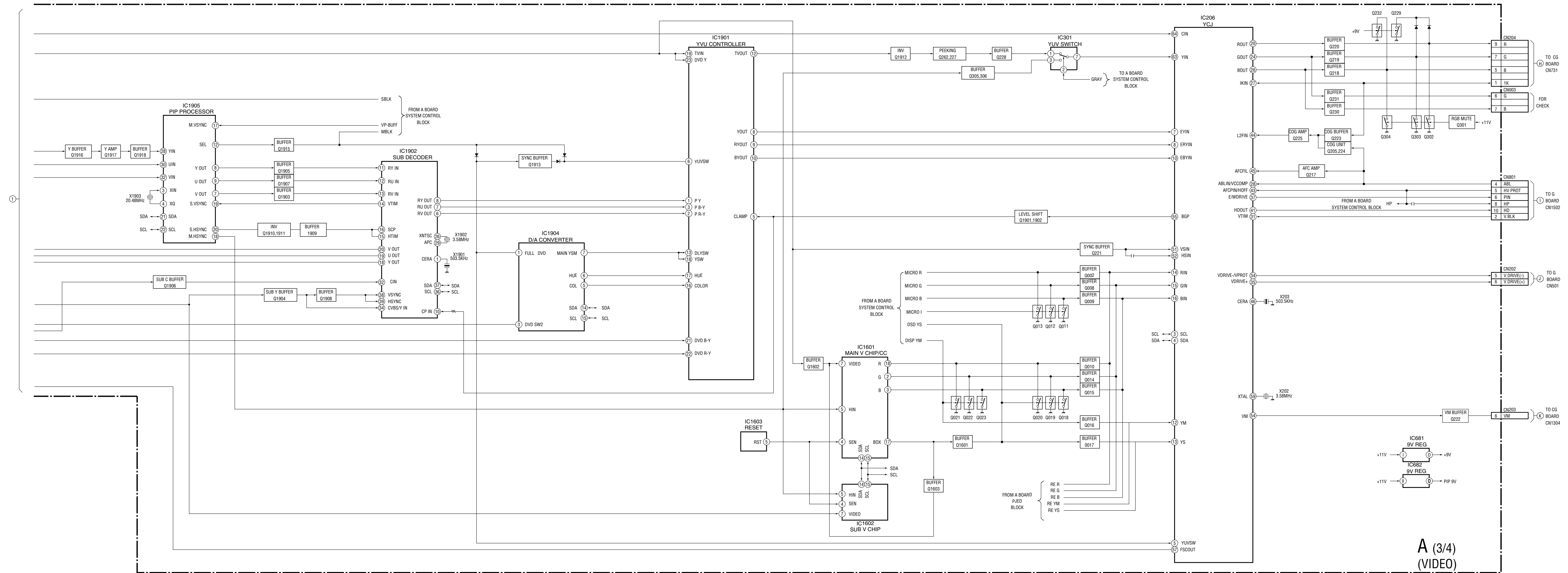

A (3/4)
(VIDEO)

BLOCK DIAGRAM (3)

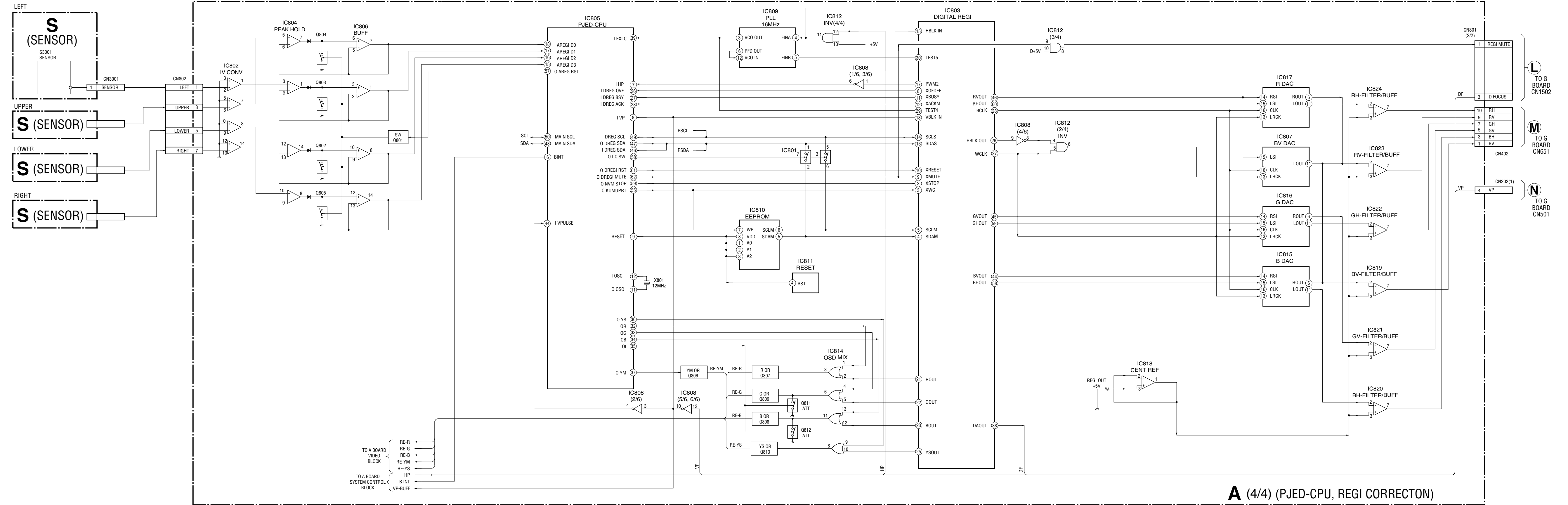

A (4/4) (PJED-CPU, REGI CORRECTON)

BLOCK DIAGRAM (4)

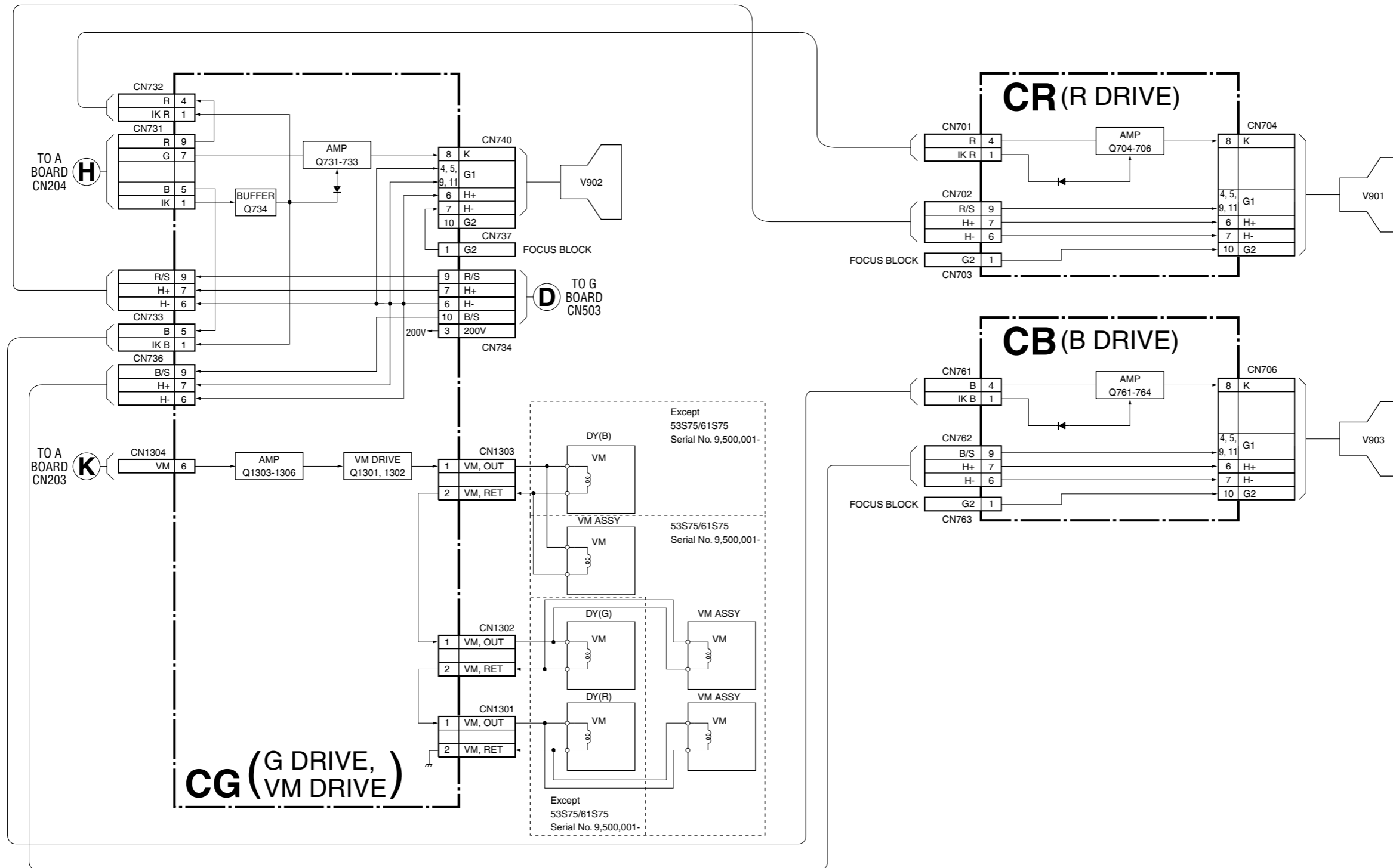

BLOCK DIAGRAM (5)

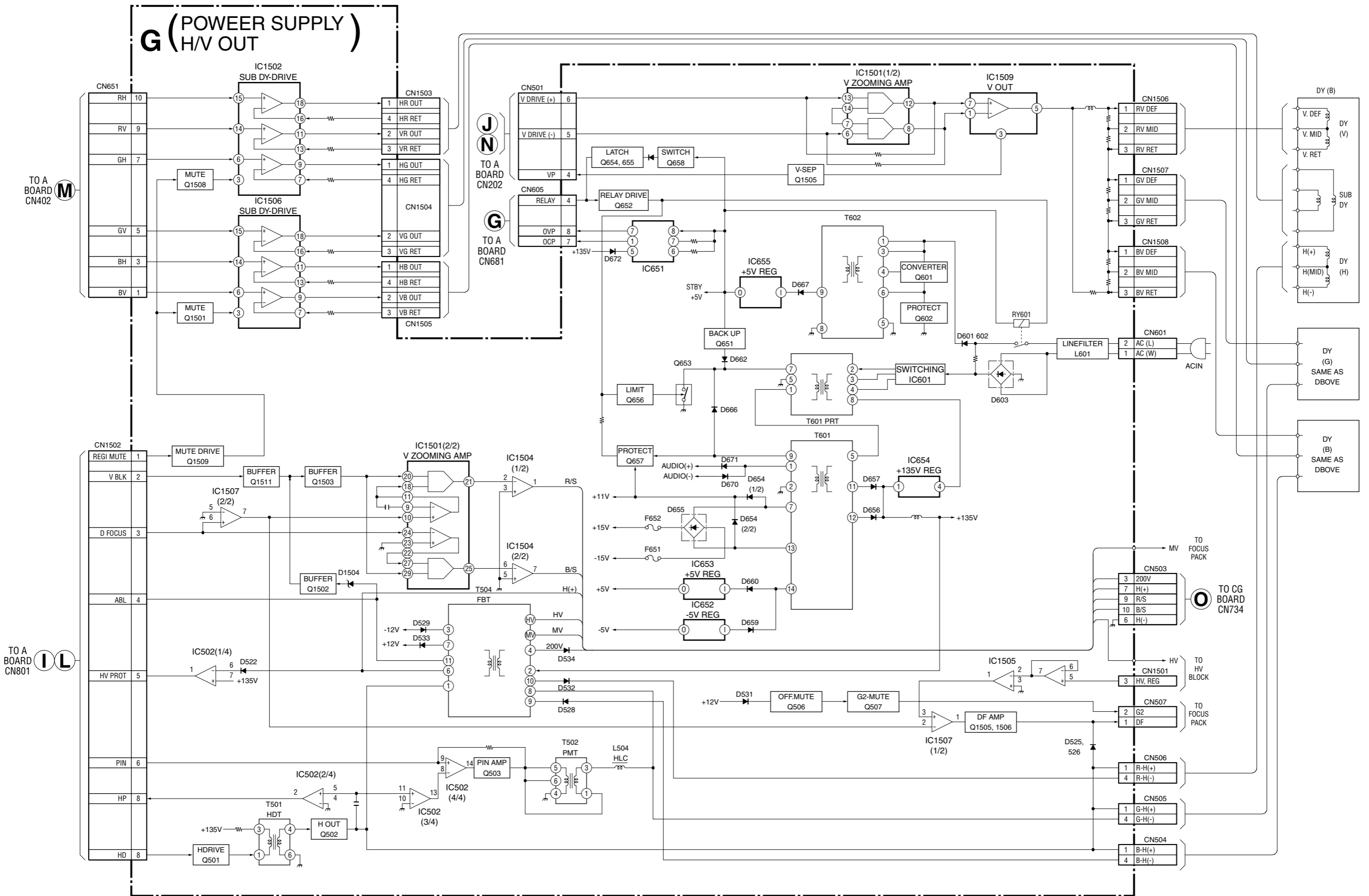

6-2. FRAME SCHEMATIC DIAGRAM

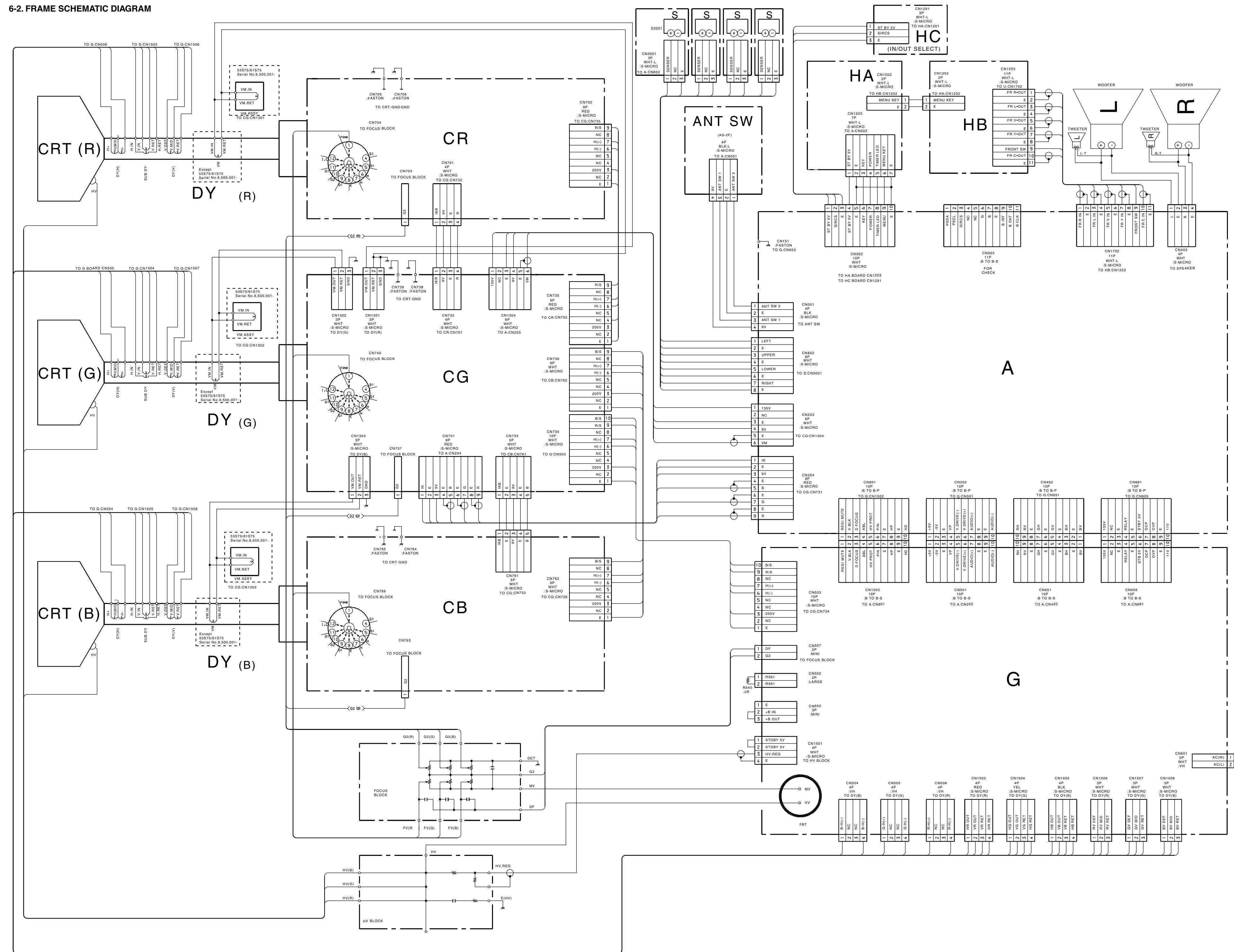

6-3. CIRCUIT BOARDS LOCATION

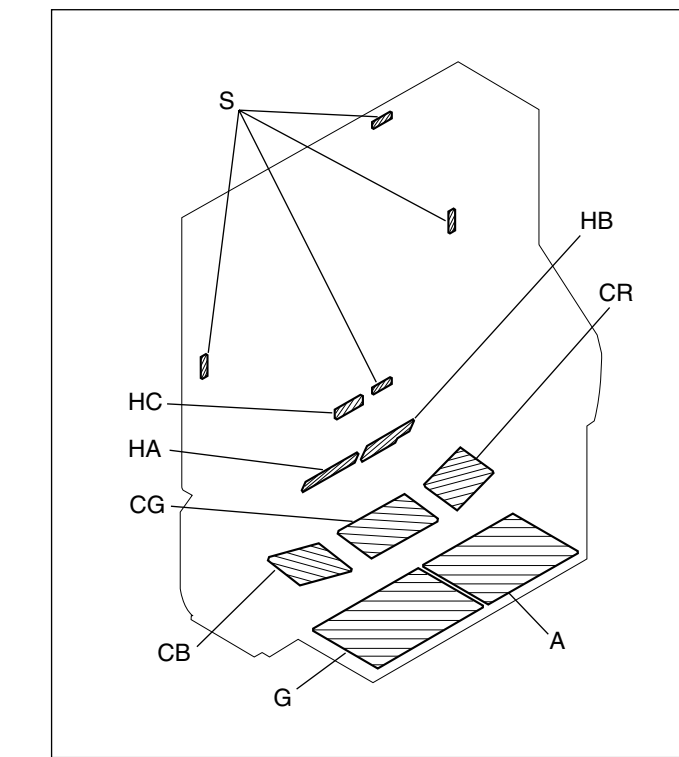

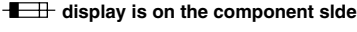
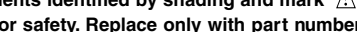
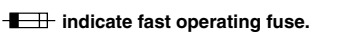
Note: The symbol  display is on the component slide.
The components identified by shading and mark  are critical for safety. Replace only with part number specified.
The symbol  indicate fast operating fuse. Replace only with fuse of same rating as marked.

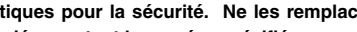
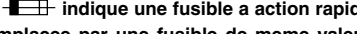

Note: Les composants identifiés par un tramé et une marque  sont critiques pour la sécurité. Ne les remplacer que par une pièce portant le numéro spécifié.
Le symbole  indique une fusible à action rapide. Doit être remplacé par une fusible de même valeur, comme marqué.

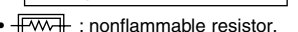
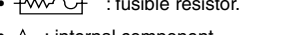
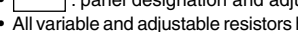
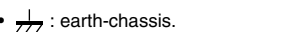
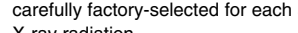
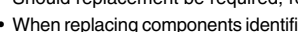
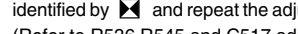
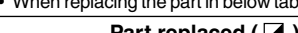
6-4. PRINTED WIRING BOARDS AND SCHEMATIC DIAGRAMS

- Note:
- Capacitors without voltage indication are all 50V.
 - All resistors are in ohms.
 - kΩ=1000Ω, MΩ=1000kΩ
 - Indication of resistance, which does not have one for rating electrical power, is as follows:
- Flitch : Sirm
Rating electrical power : 1/4 W
-  : nonflammable resistor.
 -  : fusible resistor.
 -  : internal component.
 -  : panel designation and adjustment for repair.
 - All variable and adjustable resistors have characteristic curve B, unless otherwise noted.
 -  : earth-chassis.
 - The components identified by  in this basic schematic diagram have been carefully factory-selected for each set in order to satisfy regulations regarding X-ray radiation.
 - When replacing components identified by , make the necessary adjustments indicated. If results do not meet the specified value, change the component identified by  and repeat the adjustment until the specified value is achieved. (Refer to R536, R545 and C517 adjustment on Page 51 - 52.)

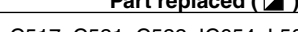
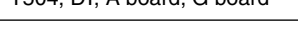









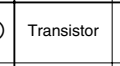
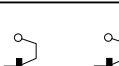
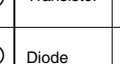
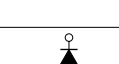
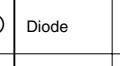

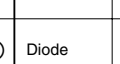
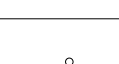
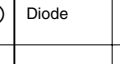
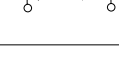
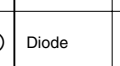
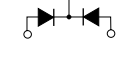
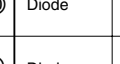
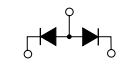
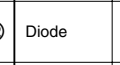
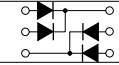
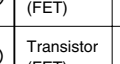
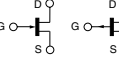
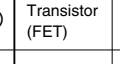
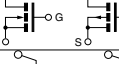
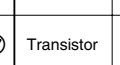
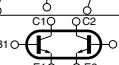
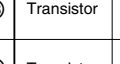
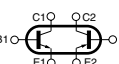
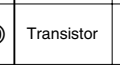
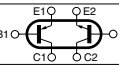
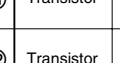
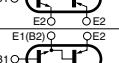
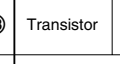
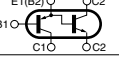
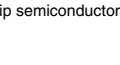

When replacing the part in below table, be sure to perform the related adjustment.

Part replaced ()	Adjustment ()
C517, C521, C522, IC654, L504, T502, T504, DY, A board, G board	HV Regulator (C517)
C516, C536, D506, D507, D522, IC206, IC502, IC654, L504, R511, R522, R536, R538, R545, R548, R584, T502, T504, DY, A board, G board	HV HOLD-DOWN (R536, R545)

- Readings are taken with a color-bar signal input.
- Readings are taken with a 10MΩ digital multimeter.
- Voltages are dc with respect to ground unless otherwise noted.
- Voltage variations may be noted due to normal production tolerances.
- All voltages are in V.
- Measurement impossibility.
- Circled numbers are waveform references.
-  : B+ bus.
-  : B- bus.
-  : signal path.(RF)

- Reference information
- RESISTOR : RN METAL FILM
: RC SOLID
: FPRD NONFLAMMABLE CARBON
: FUSE NONFLAMMABLE FUSIBLE
: RW NONFLAMMABLE WIREWOUND
: RS NONFLAMMABLE METAL OXIDE
: RB NONFLAMMABLE CEMENT
: AR ADJUSTMENT RESISTOR
: LF-BL MICRO INDUCTOR
: TA TANTALUM
: PS STYROL
: PP POLYPROPYLENE
: PT MYLAR
: MPS METALIZED POLYESTER
: MPP METALIZED POLYPROPYLENE
: ALB BIPOLAR
: ALT HIGH TEMPERATURE
: ALR HIGH RIPPLE

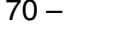
Terminal name of semiconductors in silk screen printed circuit (*)

Device	Printed symbol	Terminal name	Circuit
① Transistor		Collector Base Emitter	
② Transistor		Collector Base Emitter	
③ Diode		Cathode Anode	
④ Diode		Cathode Anode (NC)	
⑤ Diode		Cathode Anode (NC)	
⑥ Diode		Common Anode Cathode	
⑦ Diode		Common Anode Cathode	
⑧ Diode		Common Anode Anode	
⑨ Diode		Common Cathode Cathode	
⑩ Diode		Common Cathode Cathode	
⑪ Diode		Anode Cathode Anode Cathode	
⑫ Transistor (FET)		Drain Source Gate	
⑬ Transistor (FET)		Drain Source Gate	
⑭ Transistor (FET)		Drain Source Gate	
⑮ Transistor		Emitter Collector Base	
⑯ Transistor		C1 B1 E1 E1 B1 C1	
⑰ Transistor		C1 B1 E2 E1 B1 C2	
⑱ Transistor		C1 B2 E2 E1 B1 C2	
⑲ Transistor		E2 B1 E1 C2 E1 B1	
⑳ Transistor		B1 B1 E2 C1 E1 B2	
㉑ Transistor		B1 B1 E2 C1 E1 B2	
㉒ Transistor		E2 B1 E1 C1 E1 B1	

— Discrete semiconductor

(Chip semiconductors that are not actually used are included.)

• A (1/3) BOARD WAVEFORMS

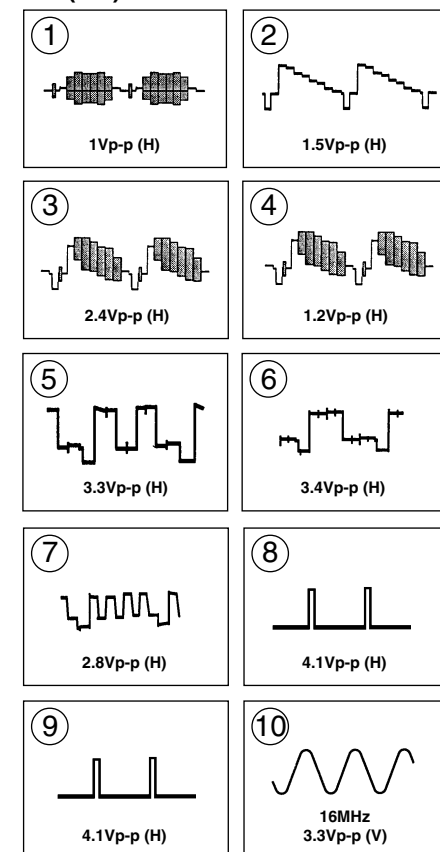

A (1/3) BOARD : IC406 TDA7265

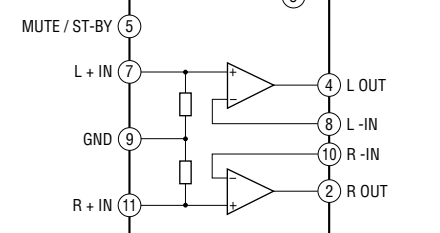

A (1/3) BOARD : IC1011 CXA2079Q

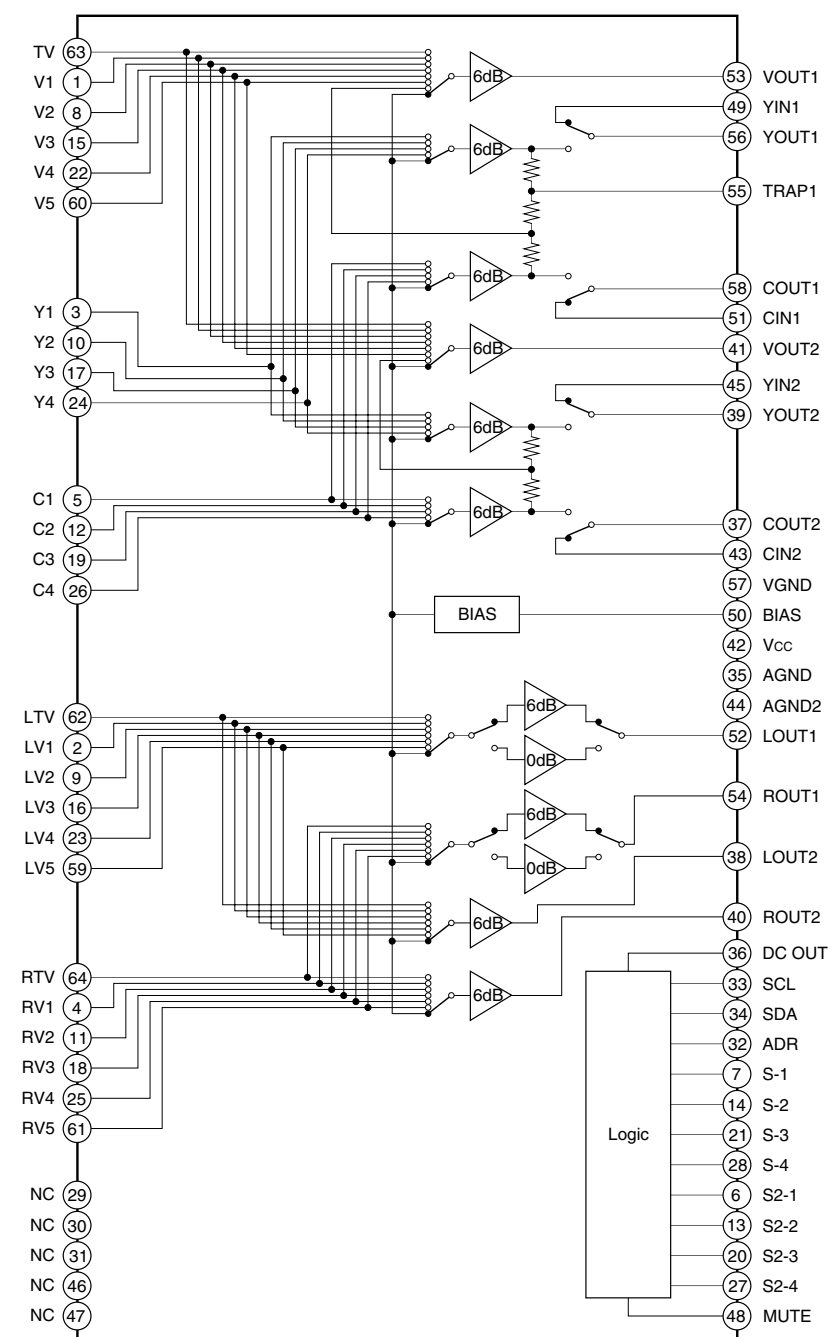

A
B
C
D
E
F
G
H
I
J
K
L
M
N
O

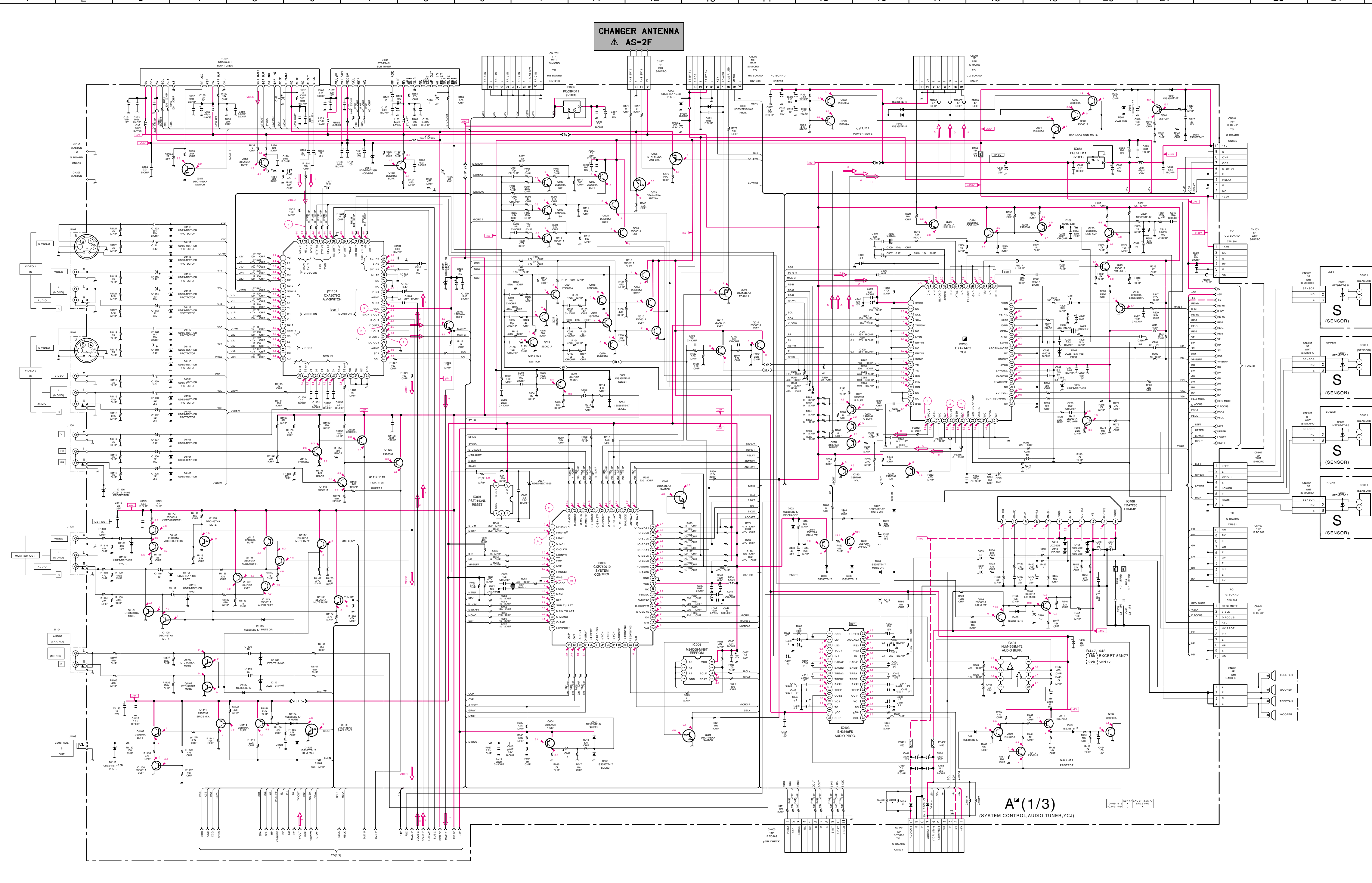

A¹(1/3)
(SYSTEM CONTROL, AUDIO, TUNER, VC)

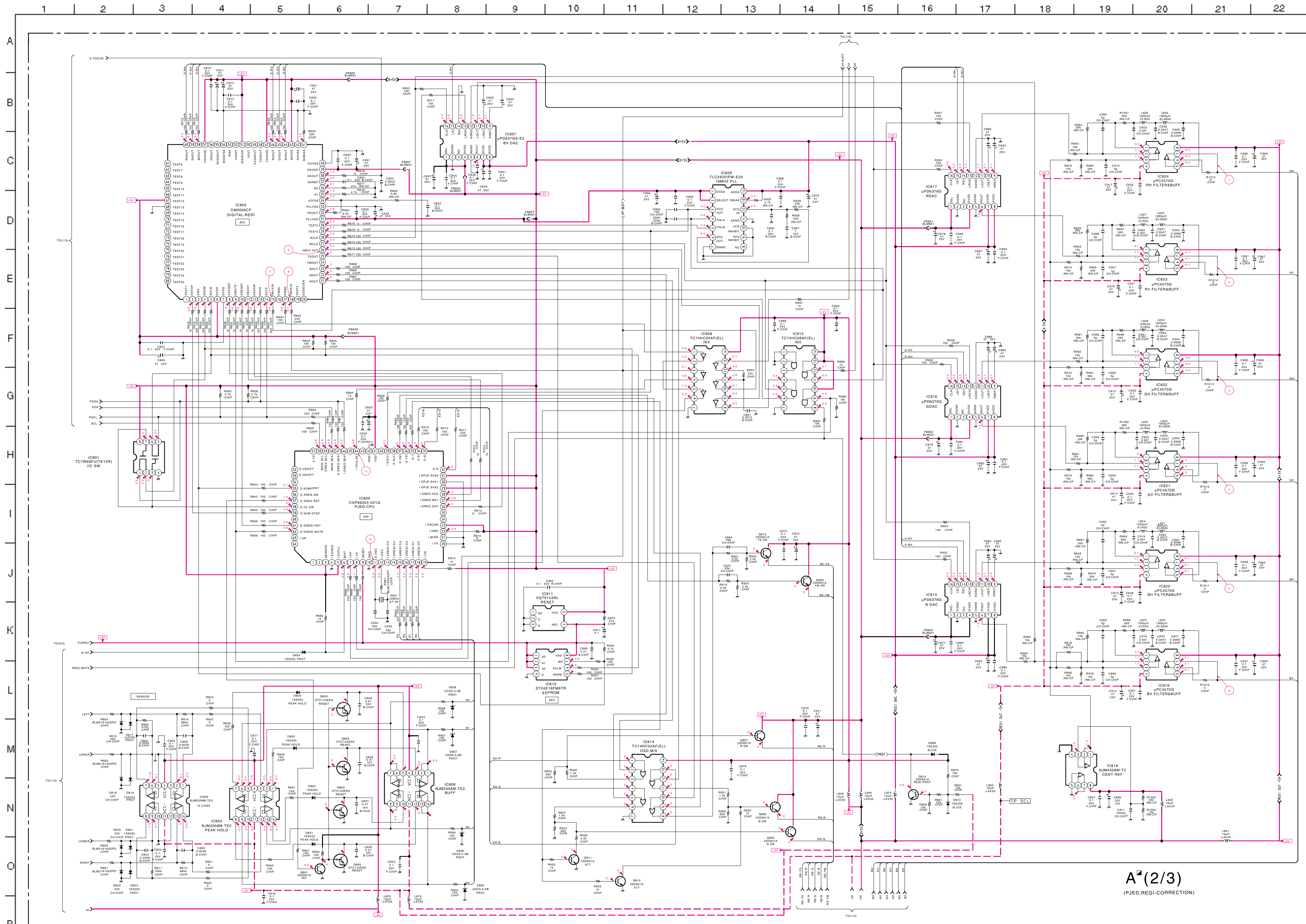

A (2/3) BOARD : IC807, 815, 816, 817
 μPD637GS-E2

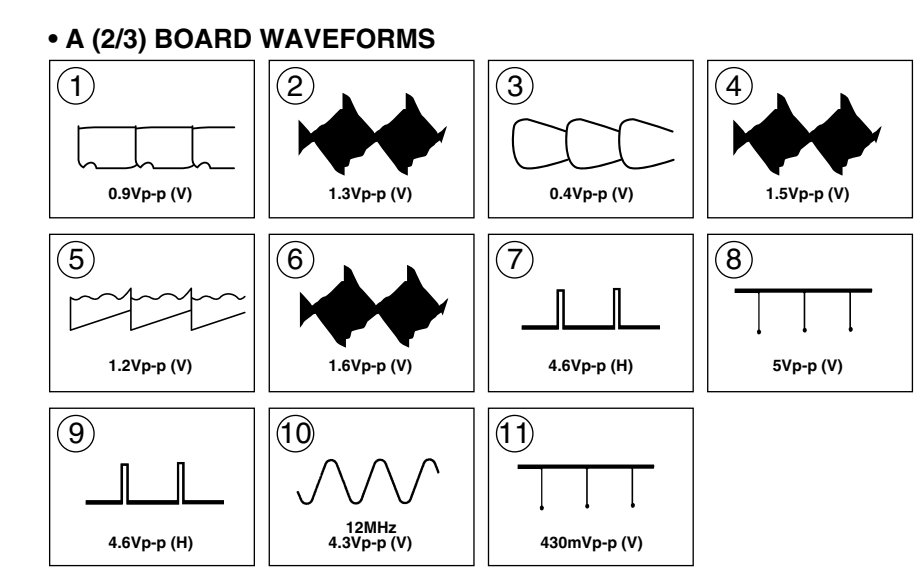
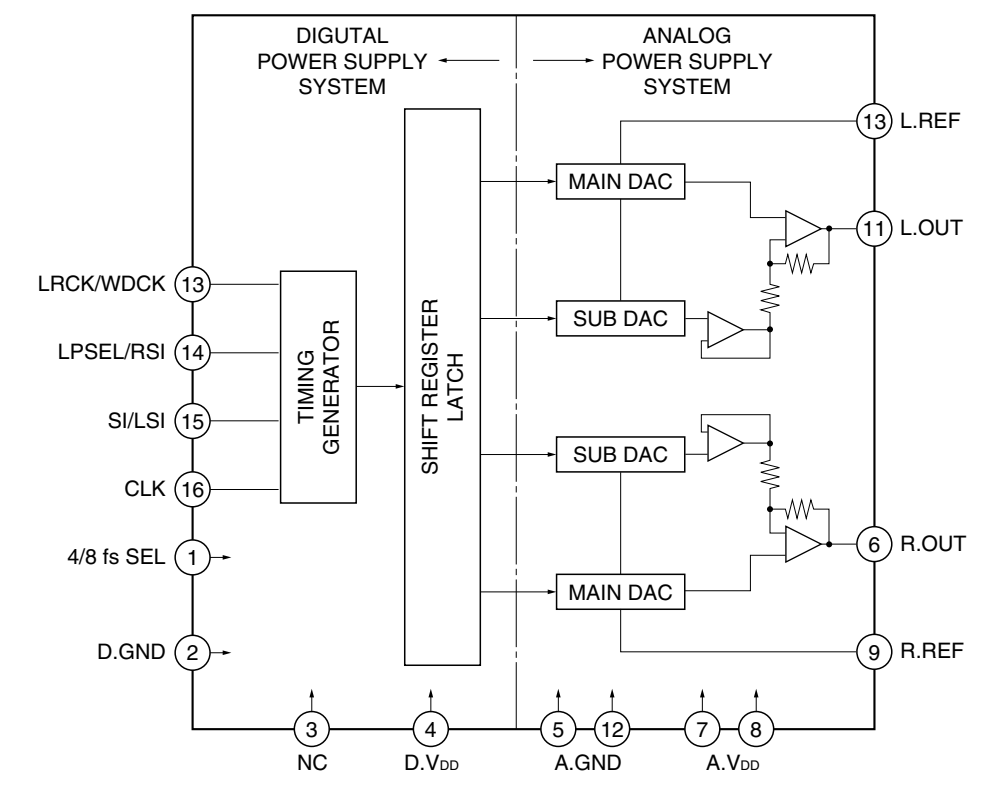

A² (2/3)
 (P.JED.REGI-CORRECTION)

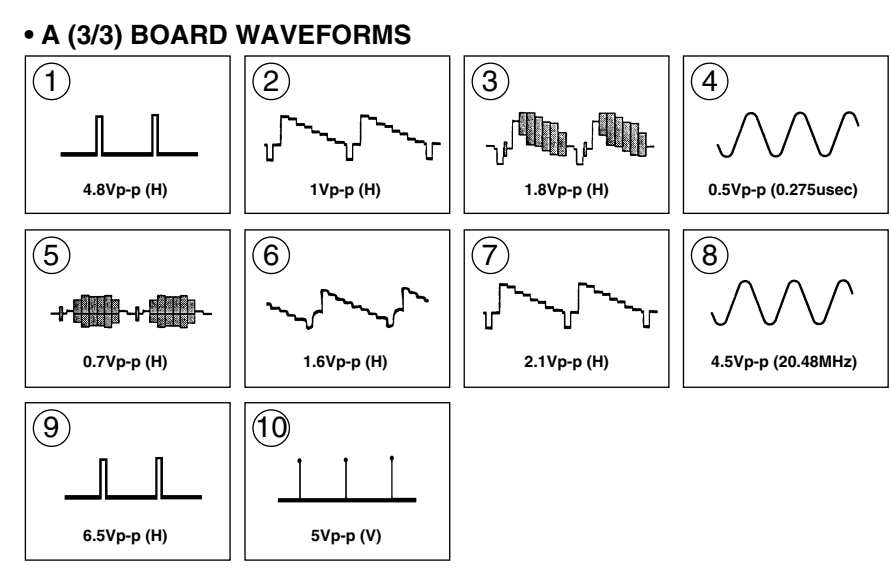
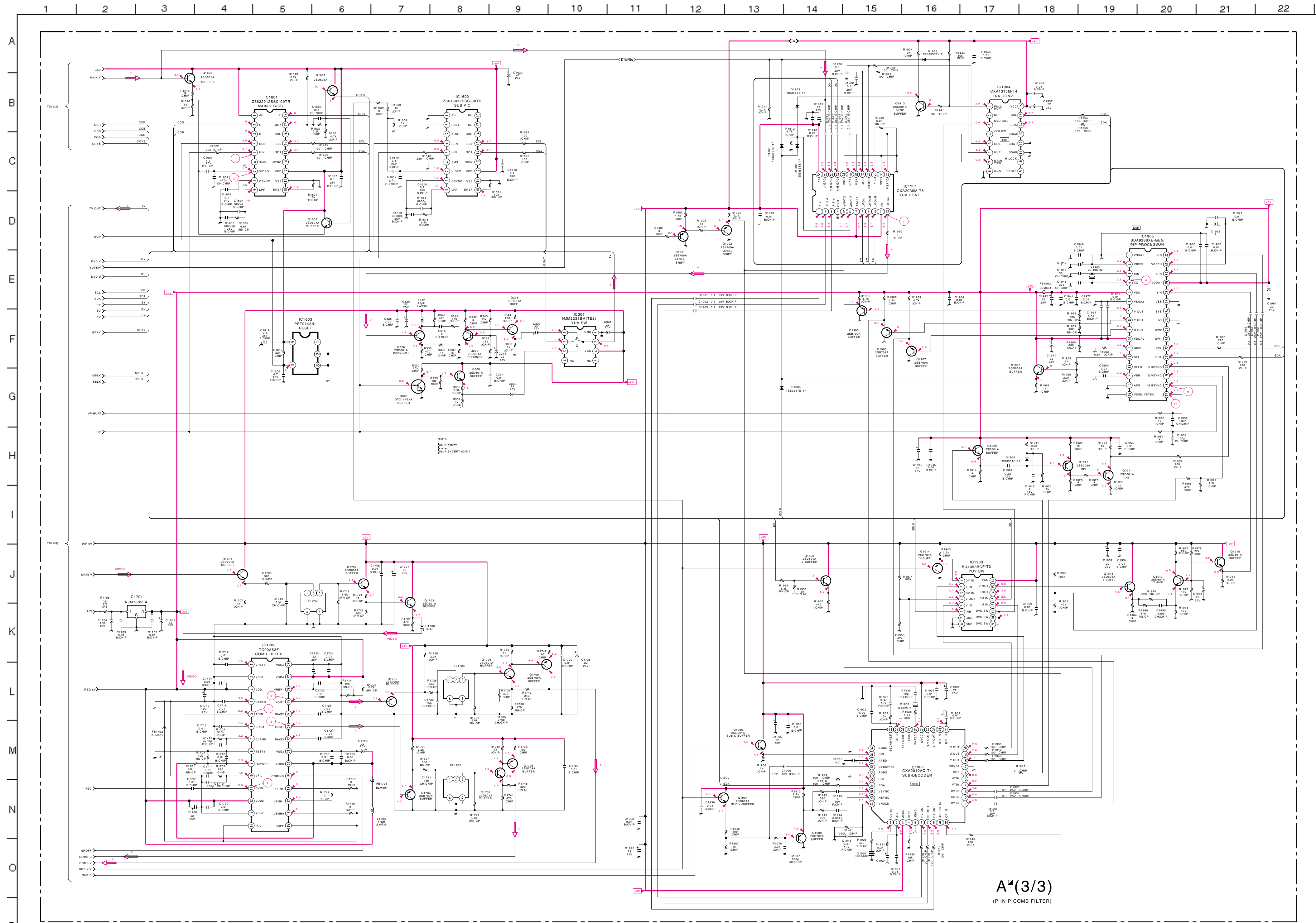

A(3/3)
(P IN P.COMB FILTER)

S [P IN P, 3D COMB FILTER]

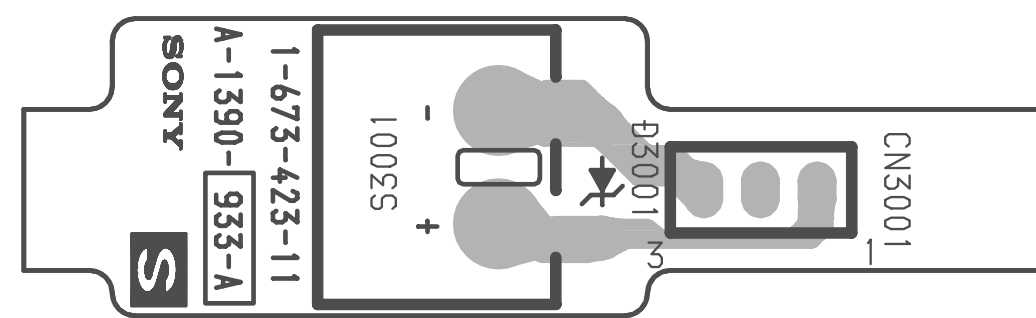

A (1/3) [TUNER, YCJ, SYSTEM CONTROL, AUDIO]

A (2/3) [PJED, REGI-CORRECTION]

A (3/3) [P IN P, 3D COMB FILTER]

- A Board -

1 2 3 4 5 6 7 8 9 10

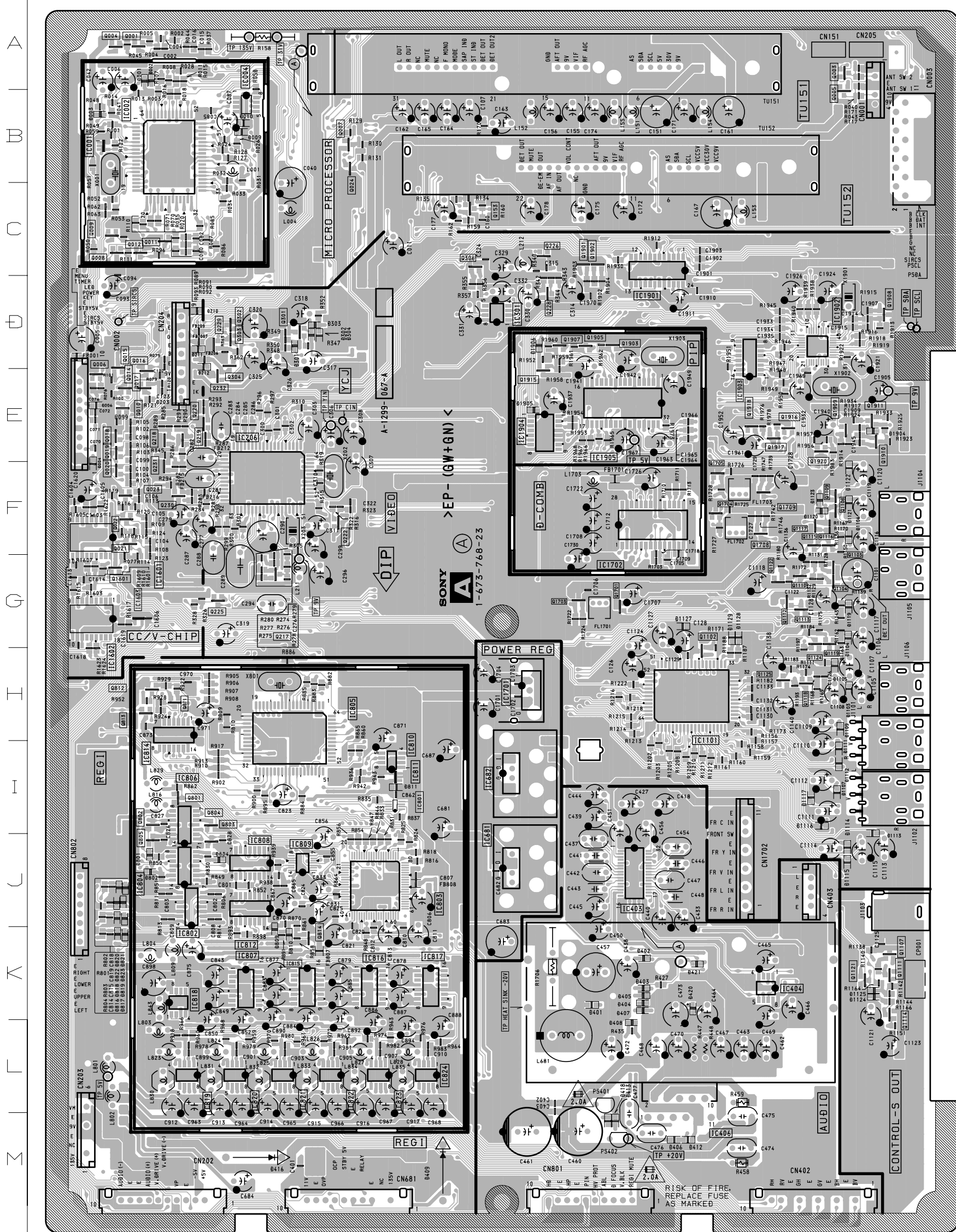

< Component Side >

A BOARD

DIODE		D404 K-7	D816 K-1	D114 J-9	TRANSISTOR		Q020 F-1	Q230 F-2	Q806 I-9	Q115 F-9	Q1902 C-7	IC004 B-2	IC816 K-4
L	R				L	R							
D001 A-2	D406 M-7	D817 K-2	D115 J-9	Q001 A-2	Q021 F-2	Q231 F-2	Q807 H-9	Q116 F-9	Q1903 D-7	IC005 B-2	IC817 K-5	IC818 K-2	
D002 A-2	D407 K-7	D818 J-1	D116 I-9	Q002 C-10	Q022 F-2	Q232 E-3	Q808 H-9	Q117 F-9	Q1904 D-2	IC006 F-3	IC819 L-2	IC820 L-3	
D003 B-1	D408 K-7	D819 J-2	D117 I-9	Q003 A-9	Q023 F-2	Q301 D-3	Q809 H-9	Q118 H-9	Q1905 D-7	IC007 J-7	IC821 L-3	IC822 L-4	
D004 F-1	D412 M-8	D820 J-1	D118	Q004 A-1	Q151	Q302 D-3	Q811 H-2	Q119 G-9	Q1906 E-2	IC008 K-8	IC823 L-4	IC824 L-5	
D005 B-10	D413 M-7	D821 J-2	D119 G-9	Q005 B-9	Q152 B-6	Q303 E-3	Q812 H-2	Q121 K-9	Q1907 D-6	IC009 L-7	IC825 L-4	IC826 L-5	
D006 E-1	D416 M-3	D822 J-1	D120 F-9	Q006 A-1	Q153 C-5	Q304 E-3	Q813 H-2	Q122 G-9	Q1908 D-10	IC010 J-5	IC827 L-4	IC828 L-5	
D101 A-2	D418 M-7	D823 J-2	D121 F-9	Q007 B-4	Q205	Q305 D-6	Q814 K-4	Q124 G-9	Q1909 E-9	IC011 H-4	IC829 J-3	IC830 J-3	
D202 G-8	D420 M-7	D824	D122 F-9	Q008 E-1	Q217 G-3	Q401 K-4	Q815 H-2	Q125 H-9	Q1910 E-10	IC012 J-2	IC831 H-4	IC832 J-4	
D206 D-9	D421 K-8	D1101 G-7	D123 F-9	Q009 C-1	Q218 E-2	Q402 K-4	Q816 H-9	Q126 G-9	Q1911 E-10	IC013 J-4	IC833 H-4	IC834 J-4	
D207 D-9	D801 J-2	D1102 G-7	D124 K-10	Q010 E-2	Q219 E-2	Q403 L-4	Q817 G-9	F-10	Q1914 E-3	IC014 J-2	IC835 H-3	IC836 J-3	
D208 H-9	D802 J-2	D1103 H-9	D125 K-10	Q011 C-2	Q220 E-2	Q404 L-4	Q818 K-2	Q1701 G-2	Q1915 E-6	IC015 H-3	IC837 H-4	IC838 J-3	
D209 G-9	D803 J-9	D1104 G-9	D126 G-1	Q012 C-2	Q221 F-7	Q408 K-3	Q819 K-2	Q1702 G-5	Q1916 E-9	IC016 J-2	IC839 J-3	IC840 J-3	
D301 D-3	D804 J-3	D1105 H-9	D127 G-8	Q013 C-4	Q222 F-4	Q409 K-3	Q820 K-3	Q1703 G-6	Q1917 E-9	IC017 K-3	IC841 J-3	IC842 J-3	
D302 D-4	D805 H-9	D1106 F-9	D128 H-2	Q014 E-2	Q223 G-9	Q410 K-4	Q821 H-2	Q1704 F-8	Q1918 E-8	IC018 J-3	IC843 J-3	IC844 J-3	
D303 D-4	D806 H-9	D1107 I-9	D129 H-2	Q015 E-1	Q224 G-9	Q411 K-4	Q822 H-2	Q1705 F-8	Q1920 E-9	IC019 H-4	IC845 J-3	IC846 J-3	
D304 D-4	D807 H-9	D1108 H-9	D130 H-2	Q016 E-2	Q225 G-3	Q801 I-2	Q823 H-2	Q1706 F-3	IC020 F-3	IC021 H-4	IC847 H-4	IC848 J-3	
D305 F-8	D808 H-9	D1109 H-9	D131 I-2	Q017 E-2	Q226 C-6	Q802 I-2	Q824 H-2	Q1707 F-3	IC022 F-3	IC023 H-4	IC849 J-3	IC850 J-3	
D402 K-7	D809 K-3	D1110	D132 I-2	Q018 E-1	Q227 D-5	Q803 J-2	Q825 H-2	Q1708 F-8	IC024 H-2	IC025 H-4	IC851 H-4	IC852 J-3	
D403 K-7	D810 K-3	D1111 I-9	D133 I-9	Q019 E-1	Q228 D-6	Q804 I-2	Q826 H-2	Q1709 F-8	IC025 B-1	IC026 H-2	IC853 H-4	IC854 L-4	
		D1112 I-9	D134 I-9		Q229 D-2	Q805 J-2	Q827 H-2	Q1901 C-6	IC001 B-1	IC002 B-2			

L: component side
R: conductor side

1 2 3 4 5 6 7 8 9 10

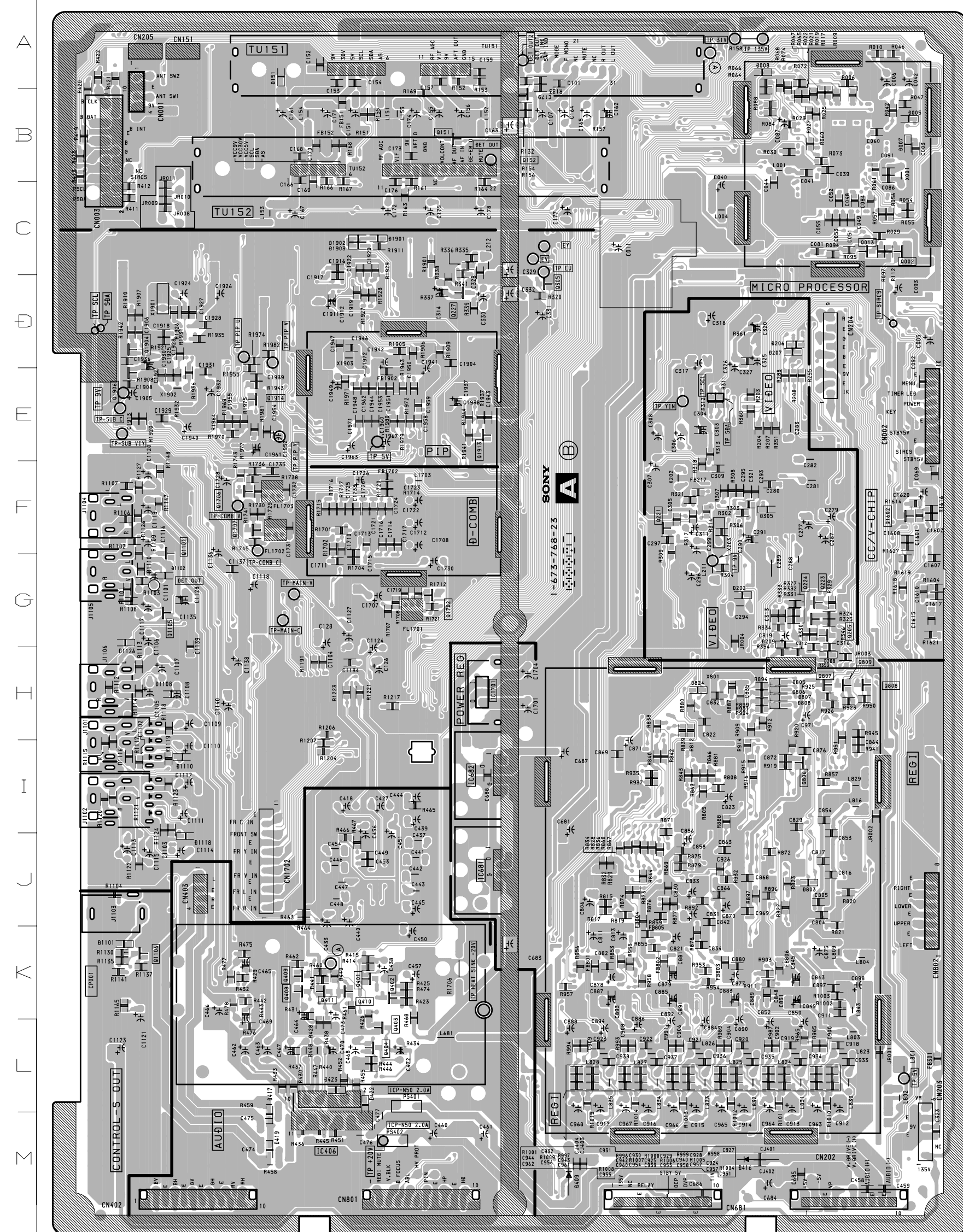

< Conductor Side >

A (3/3) BOARD : IC1902 CXA2019AQ-T4

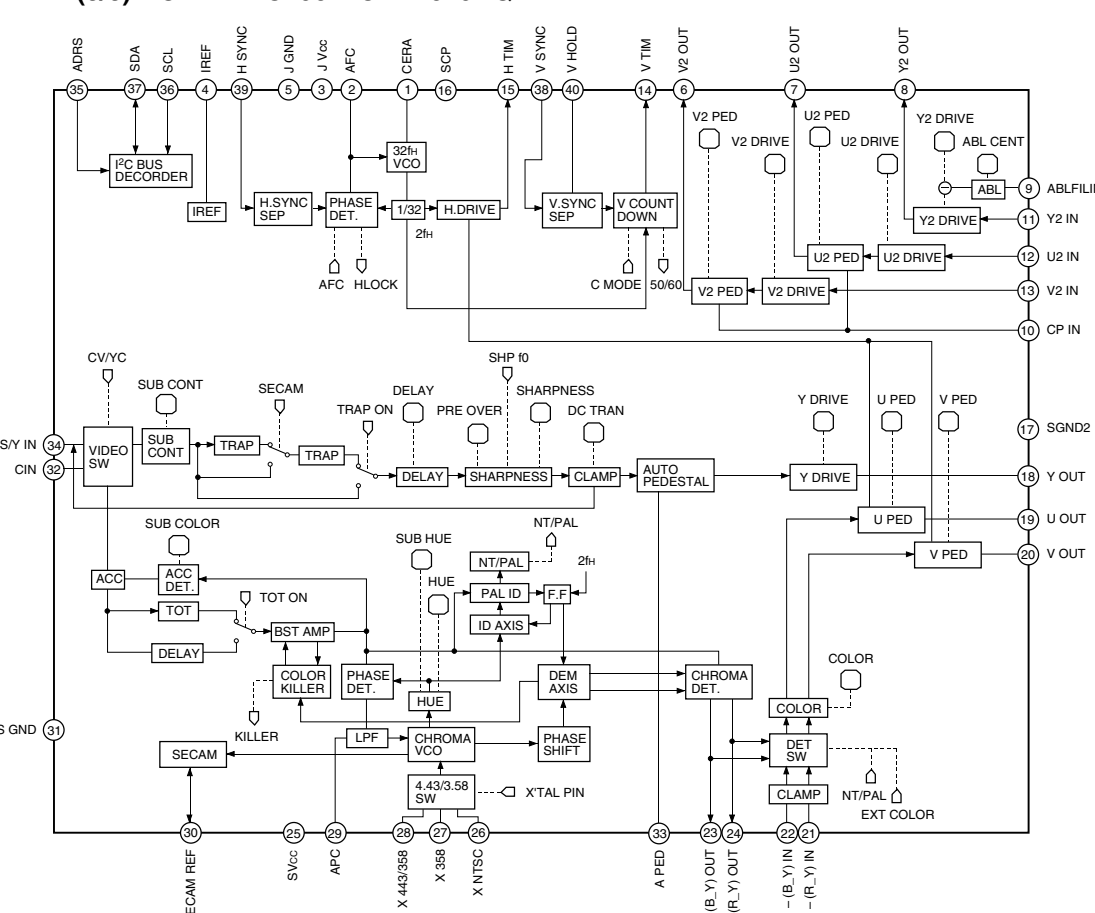

A (3/3) BOARD : IC1903 BU4053BCF-T2

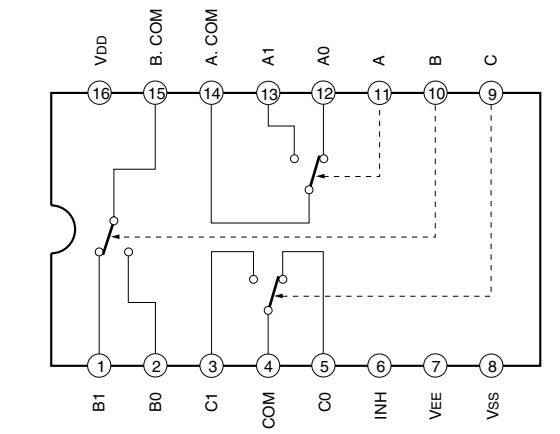

A (3/3) BOARD : IC1904 CXA1315M-T4

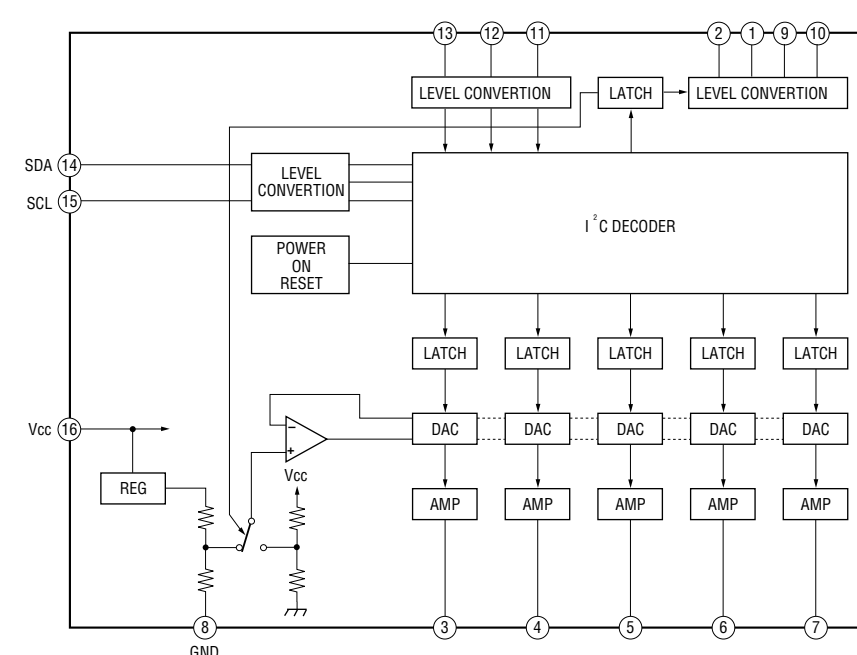

A (3/3) BOARD : IC1905 SDA9288

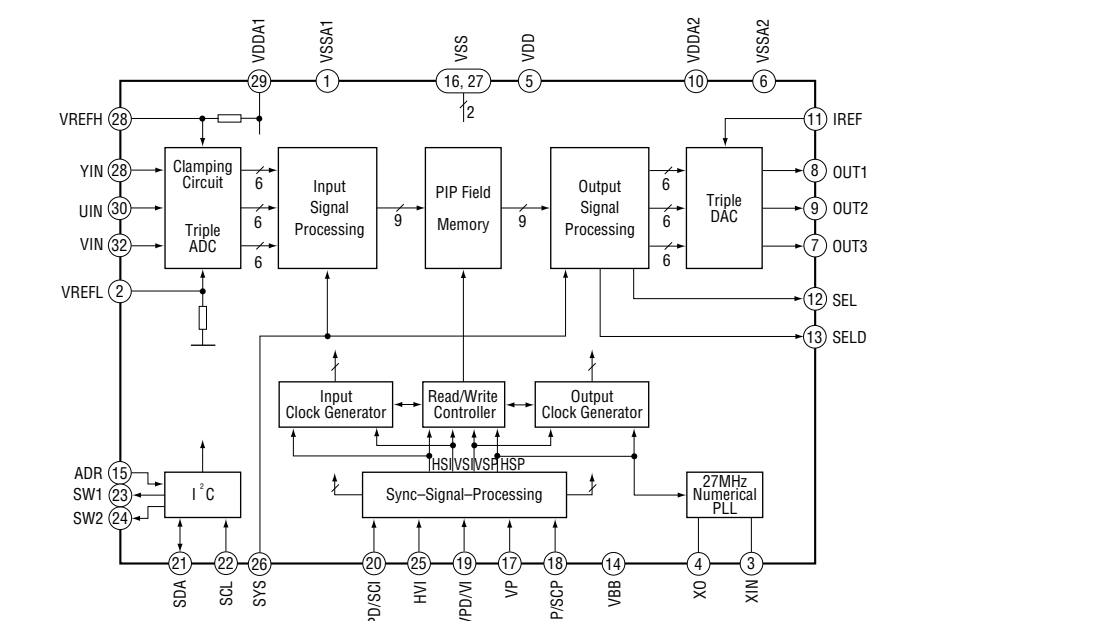

A
B
C
D
E
F
G
H
I
J
K
L
M
N
O
P

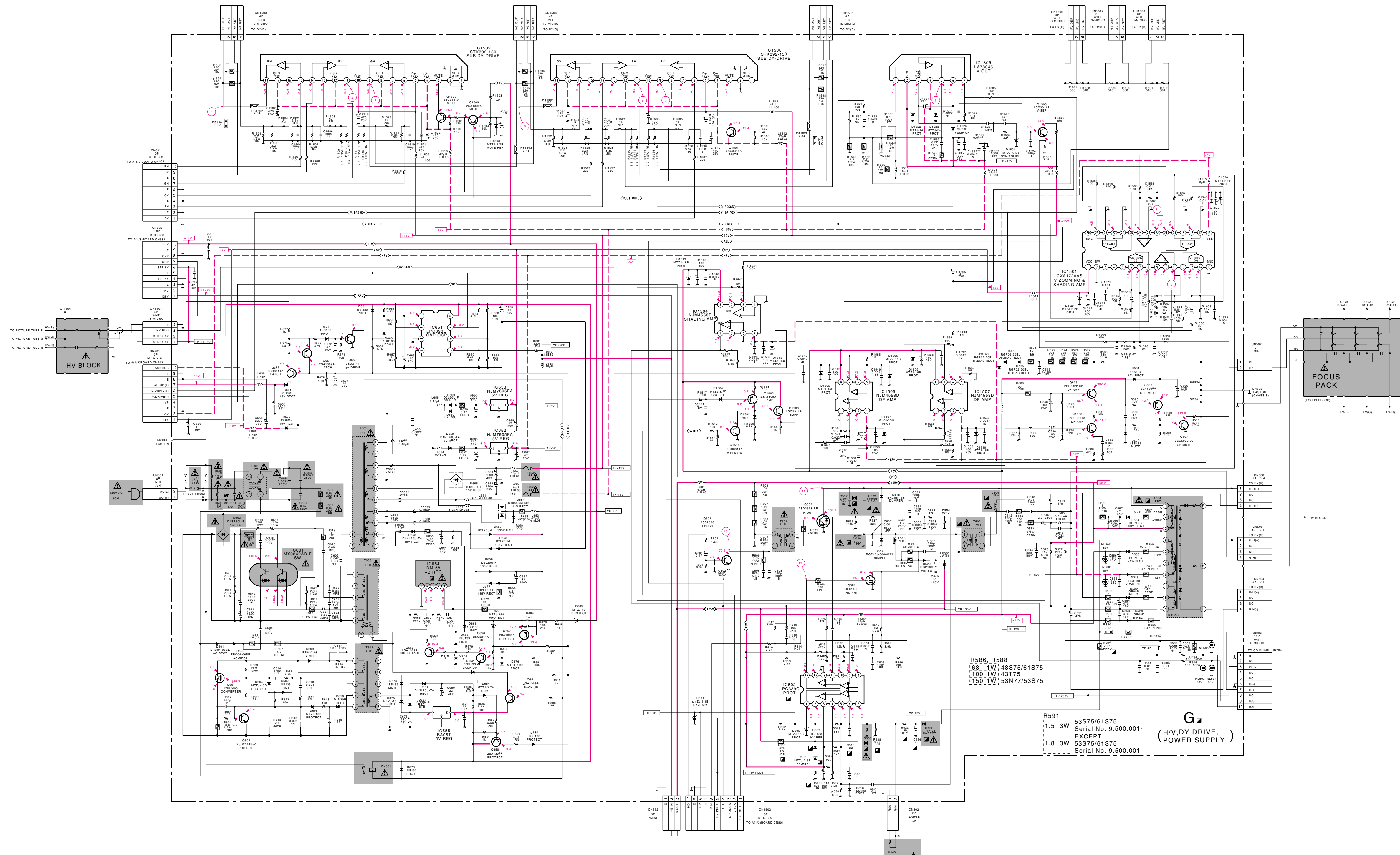
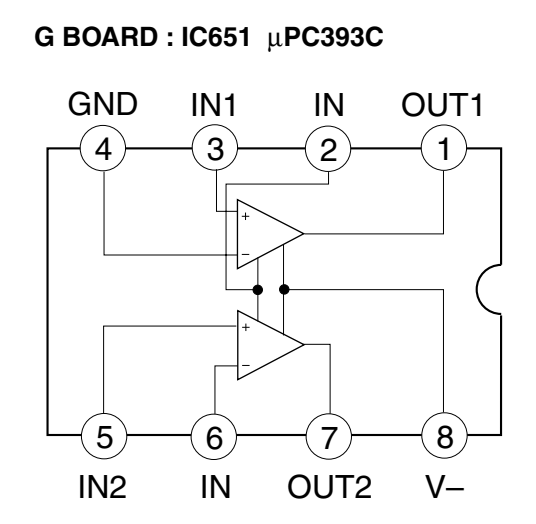
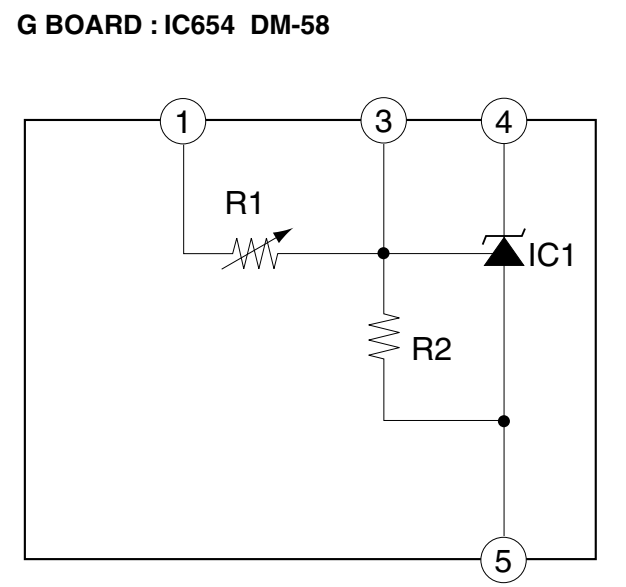
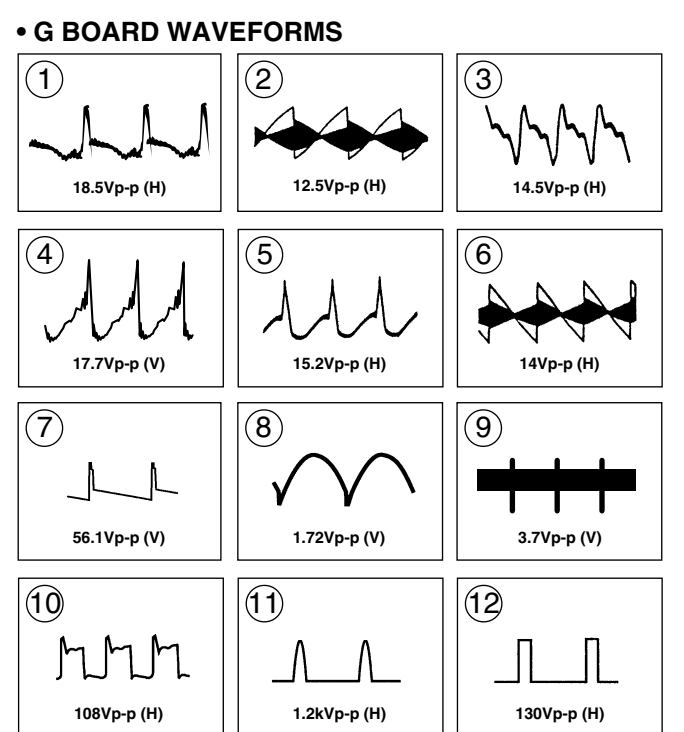

R586, R588
 168 1W, 48S75/61S75
 100 1W, 4375
 150 1W, 53N77/53S75

R591 --- 53S75/61S75
 1.5 3W, Serial No. 9,500,001-
 EXCEPT
 1.8 3W, 53S75/61S75
 Serial No. 9,500,001-

G
 (H.V. DY DRIVE,
 POWER SUPPLY)

- G Board -

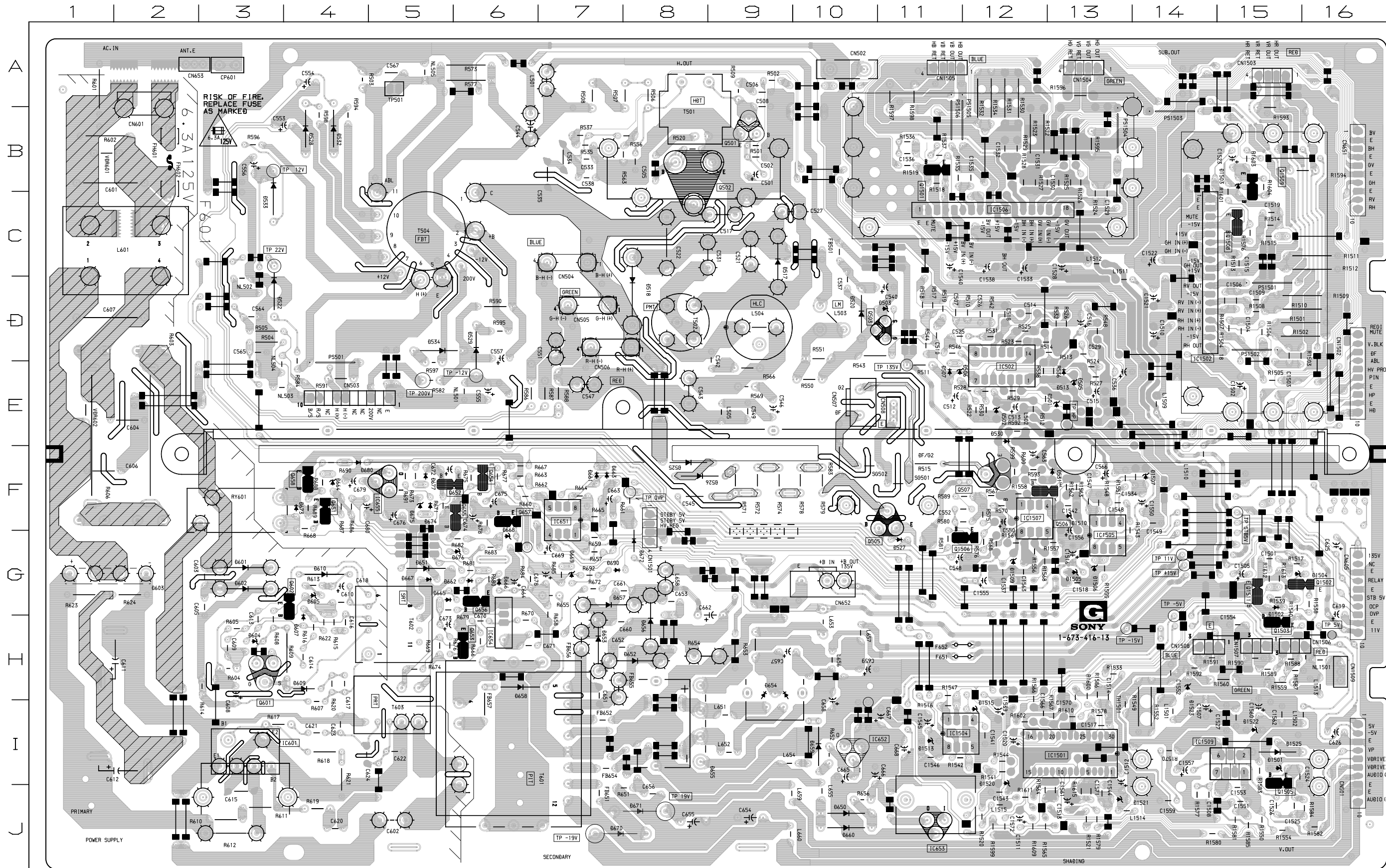

G BOARD

DIODE		D1503	B-15
D501	E-13	D1504	G-15
D505	E-13	D1505	G-13
D506	E-11	D1506	G-13
D507	E-11	D1507	F-14
D513	E-13	D1509	G-12
D517	C-9	D1510	F-13
D518	D-8	D1513	I-11
D520	D-10	D1515	I-12
D522	D-3	D1520	J-12
D525	F-8	D1521	J-13
D526	F-8	D1522	I-15
D528	B-4	D1523	H-14
D529	D-6	D1525	I-15
D530	E-12		
D531	F-13	TRANSISTOR	
D532	B-4	Q501	B-9
D533	B-6	Q502	B-8
D534	D-5	Q503	D-11
D601	G-3	Q505	F-11
D602	G-3	Q506	F-12
D603	G-2	Q507	F-12
D604	H-3	Q601	H-3
D605	G-4	Q602	G-4
D607	H-4	Q651	F-4
D609	H-4	Q652	F-5
D610	G-4	Q653	H-6
D651	G-5	Q654	F-6
D652	H-8	Q655	F-5
D653	H-7	Q656	G-6
D654	H-9	Q657	F-6
D655	I-8	Q658	F-4
D656	H-8	Q1501	B-11
D657	G-7	Q1502	G-15
D658	H-6	Q1503	H-15
D659	I-10	Q1505	I-15
D660	J-10	Q1506	G-11
D661	F-7	Q1508	C-15
D662	G-6	Q1509	B-15
D663	F-7	Q1511	G-15
D664	F-4	IC	
D665	G-5	IC502	E-12
D666	G-6	IC601	I-3
D667	G-5	IC651	F-7
D668	G-6	IC652	I-10
D669	G-7	IC653	J-11
D670	J-7	IC654	H-6
D671	J-8	IC655	F-5
D673	F-4	IC1501	I-13
D674	F-5	IC1502	D-14
D675	F-5	IC1504	I-11
D676	G-6	IC1505	G-13
D677	F-5	IC1506	C-12
D680	F-4	IC1507	F-12
D1501	I-15	IC1509	I-15

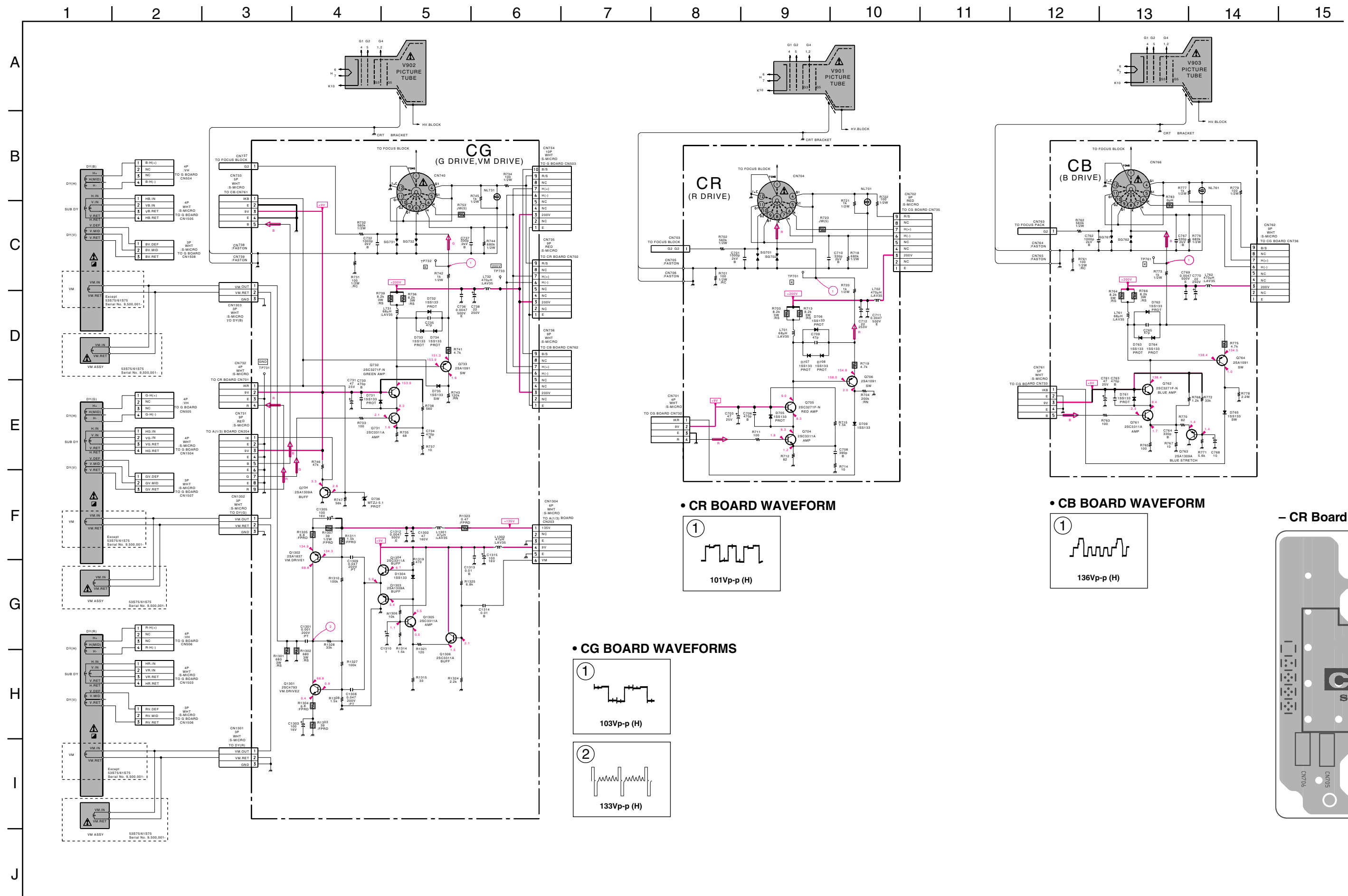

CG [G DRIVE, VM DRIVE] **CR** [R DRIVE] **CB** [B DRIVE]

- CG Board -

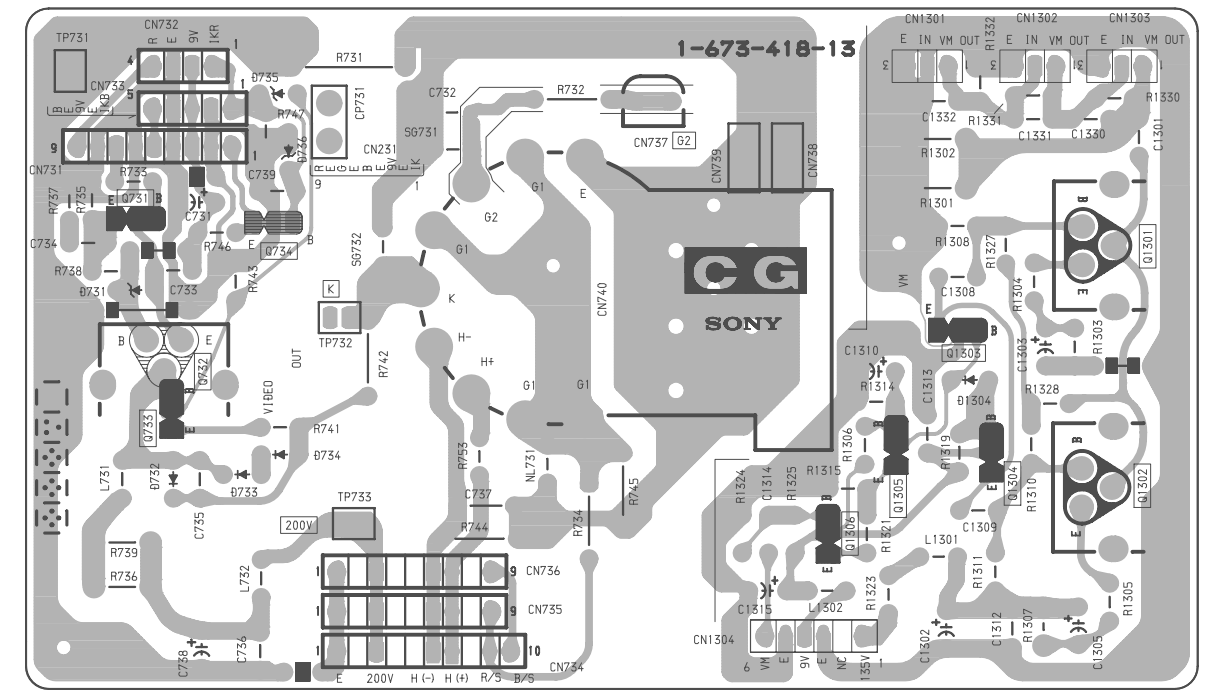

• CR BOARD WAVEFORM

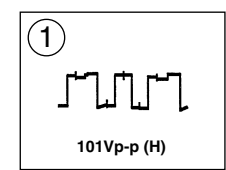

• CB BOARD WAVEFORM

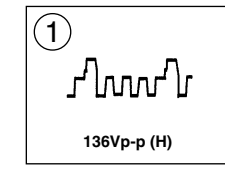

• CG BOARD WAVEFORMS

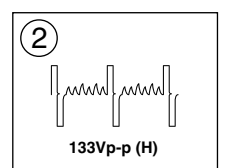
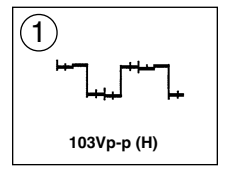

- CR Board -

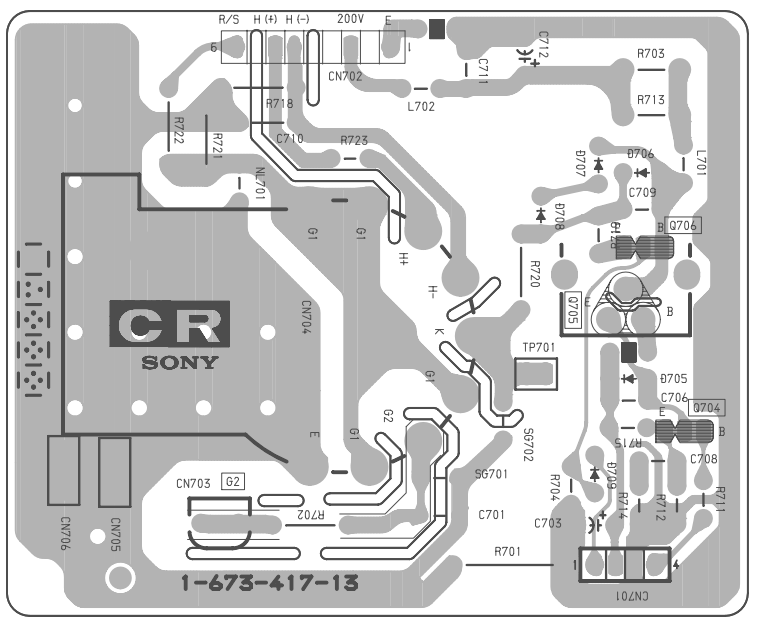

- CB Board -

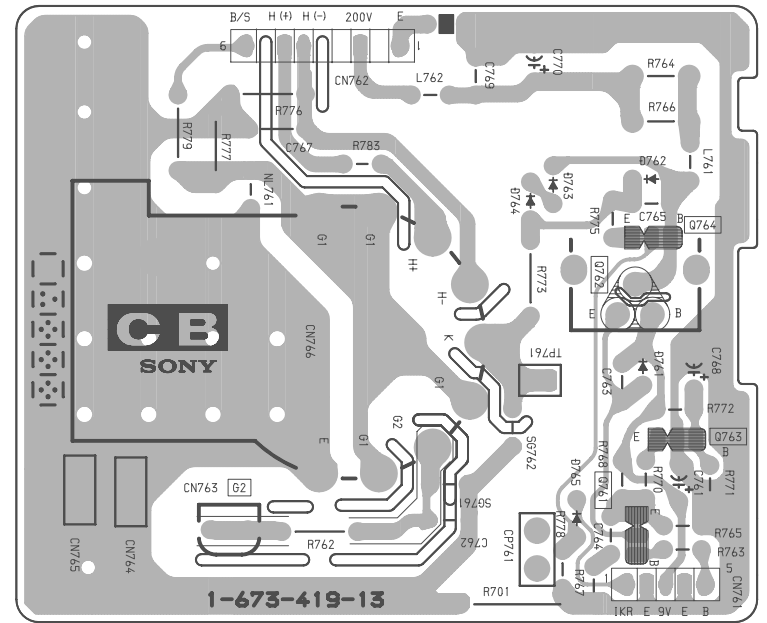

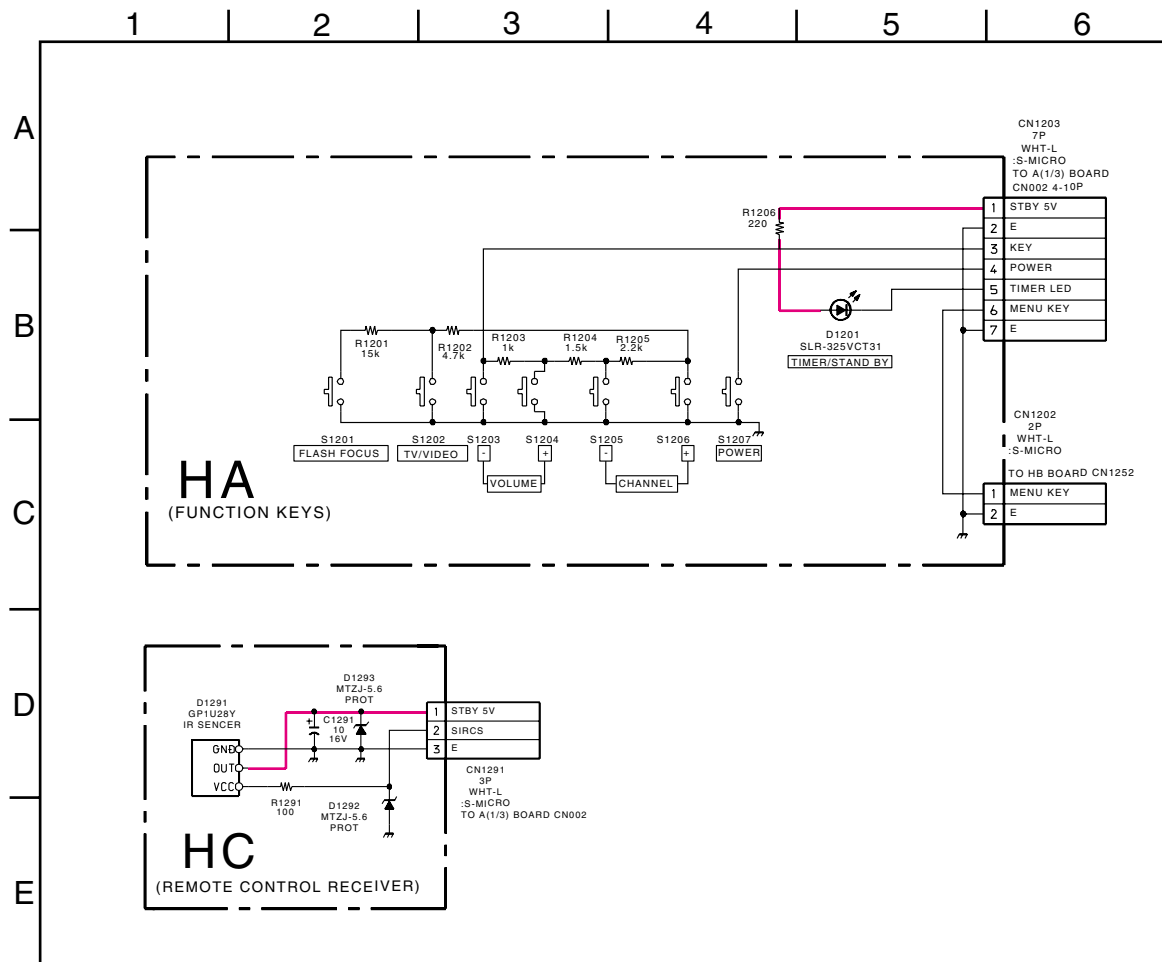

HA [FUNCTION KEK] **HC** [RIMOTE CONTROL RECEIVER]

- HA Board -

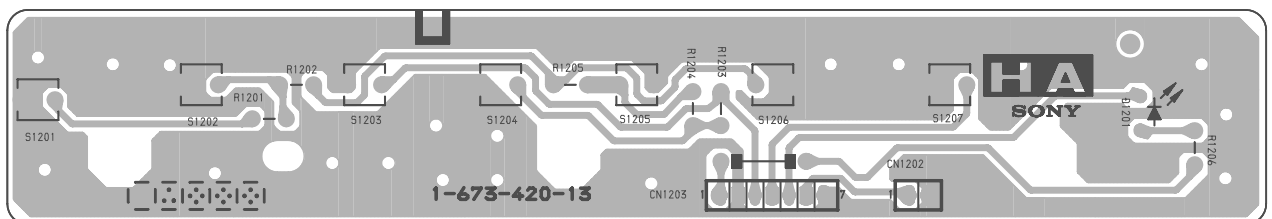

- HC Board -

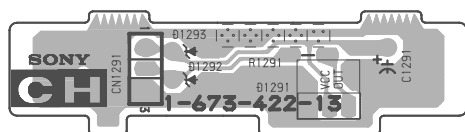

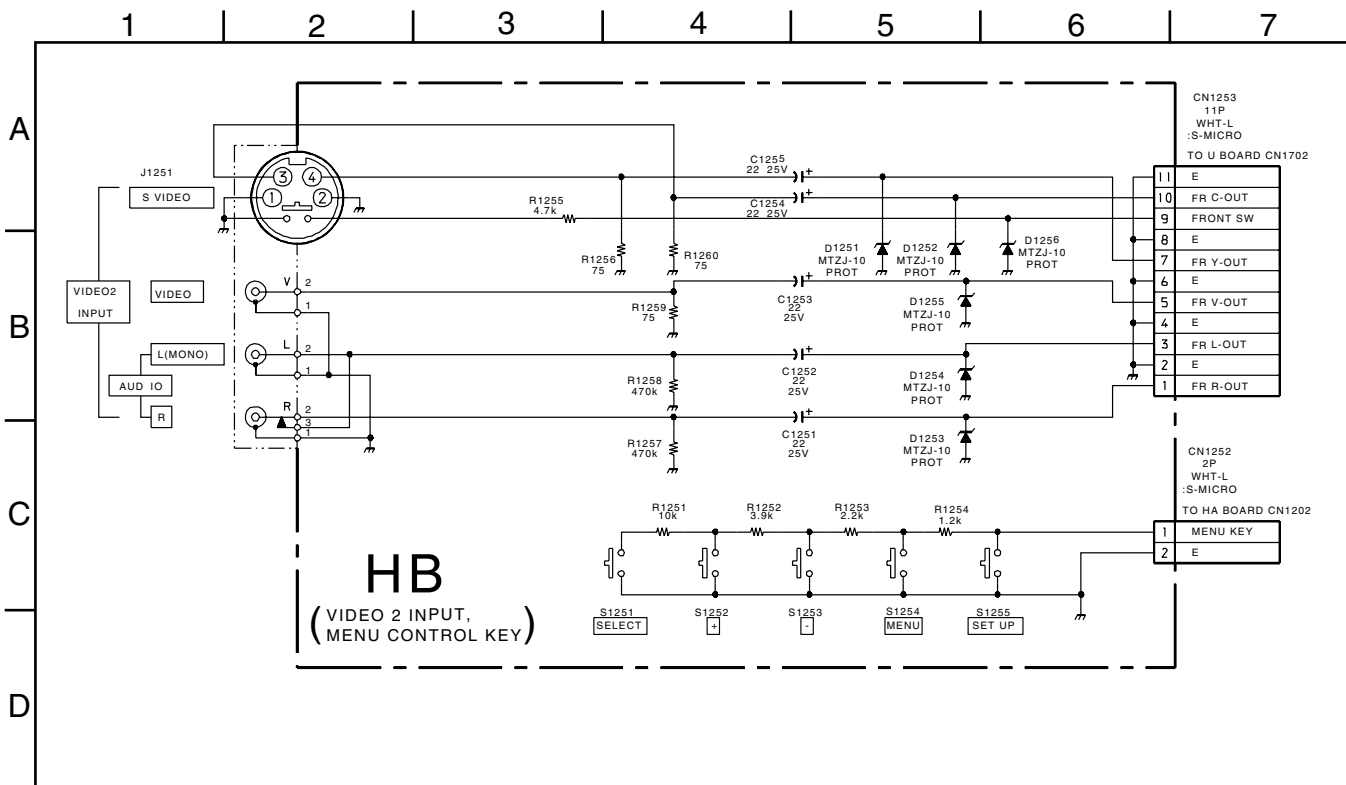

HB [VIDEO-2 INPUT, MENU CONTROL KEYS]

- HB Board -

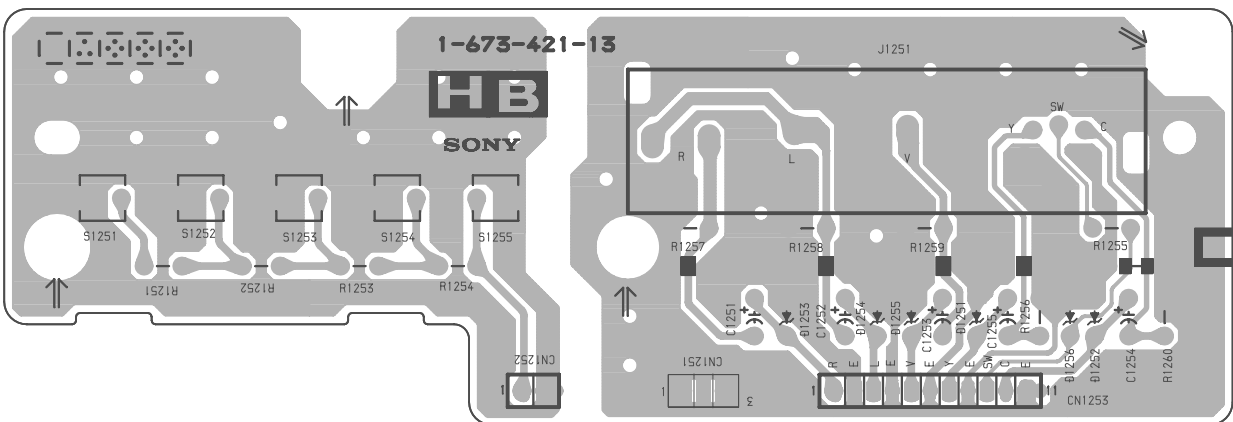

6-5. SEMICONDUCTORS

BA05T

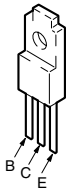

CXA2039M-T6

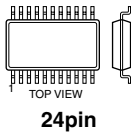

NJM7805FA

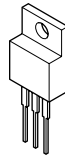

UPC339C

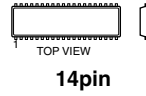

2SA1175-HFE
2SA1309A
2SC2785-HFE
2SC3311A

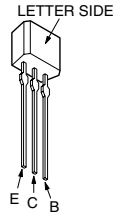

BH3868FS-E2
SDA9288XE

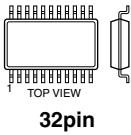

DM-58

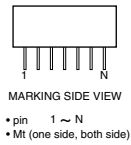

NJM7905FA

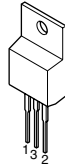

Z8613012SSC-00TR
Z8622912SSC-00TR

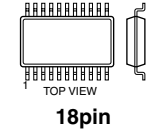

2SC5022-02

BU4053BCF-T2
CXA1315M
UPD6376GS-E2

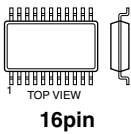

LA78045



PQ09RD11

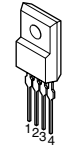

2SA1091-O

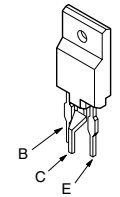
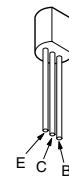

CM0006CF

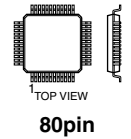

M24C08-MN6T
NJM2533M(TE2)
NJM4558M-T2
ST24E16FM6TR
TC7W66FU(TE12R)
UPCM4570G2

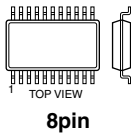

PST9143NL

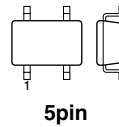

2SA1837
2SC4793
IRF614

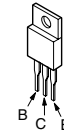

2SD2144S-UVV
2SD2144S-V

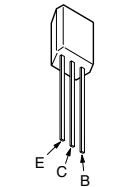

CXA1726AS



MC74HC04AF
MC74HC32AF
NJM2058M-TE2
TC74HC08AF(EL)
TLC2932IPW

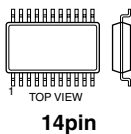

STK392-150

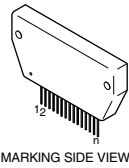

2SC2611
2SC2688-(5)LK

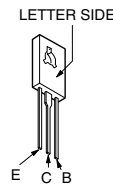

2SD2578-RF

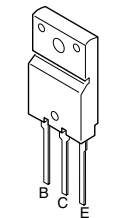

CXA2079Q
CXA2147Q
CXP750010-026Q
CXP86324-024Q

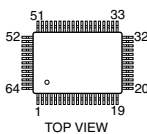

NJM4558D
UPC393C

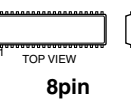

TC90A53F

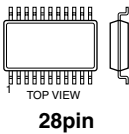

2SA1162-G
2SD601A-Q
DTC143TKA-T146
DTC144EKA-T146

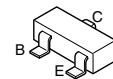

2SK2663

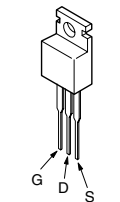

CXA2019AQ-T4

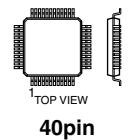

TDA7265

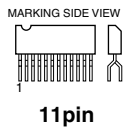

11ES2
D1N20R
D1NL20U
D2L20U
MTZJ-10B
MTZJ-13
MTZJ-15B
MTZJ-2.7A
MTZJ-3.9B
MTZJ-4.7C
MTZJ-5.1B
MTZJ-7.5B
MTZJ-T-77-15B
MTZJ-T-77-18B
MTZJ-T-77-24A
MTZJ-T-77-5.6B
MTZJ-T-77-6.2B
MTZJ-T-77-8.2B

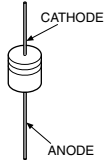

1SS133-T17
D3S6M-F
ERA22-08
ERC04-06SE
ERC06-15S
ERC91-02

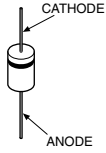

1SS355TE-17
UDZ-TE17-10B
UDZ-TE17-22B
UDZ-TE17-33B
UDZS-TE17-5.6B
UDZS-TE17-8.2B

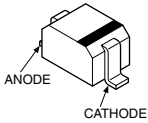

D10SC6M-4012

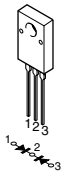

D1NL20U

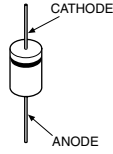

D1NS6
EL1Z
GP08DPKG23
RGP02-20EL-6394
RGP10GPKG23
RGP15J-6040G23

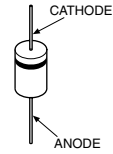

D4SBS4-F

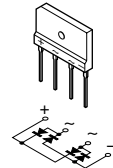

SLR-325VCT31

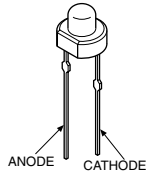

SECTION 7 EXPLODED VIEWS

NOTE:

- Items with no part number and no description are not stocked because they are seldom required for routine service
- The construction parts of an assembled part are indicated with a collation number in the remark column.
- Items marked " * " are not stocked since they are seldom required for routine service. Some delay should be anticipated when ordering these items.

The components identified by shading and mark are critical for safety. Replace only with part number specified.

Les composants identifiés par une trame et une marque sont critiques pour la sécurité. Ne les remplacer que par une pièce portant le numéro spécifié.

7-1. COVER (KP-43T75)

- : +BVTP 3X12 7-685-648-79
- : +BVTP 4X12 7-685-661-14

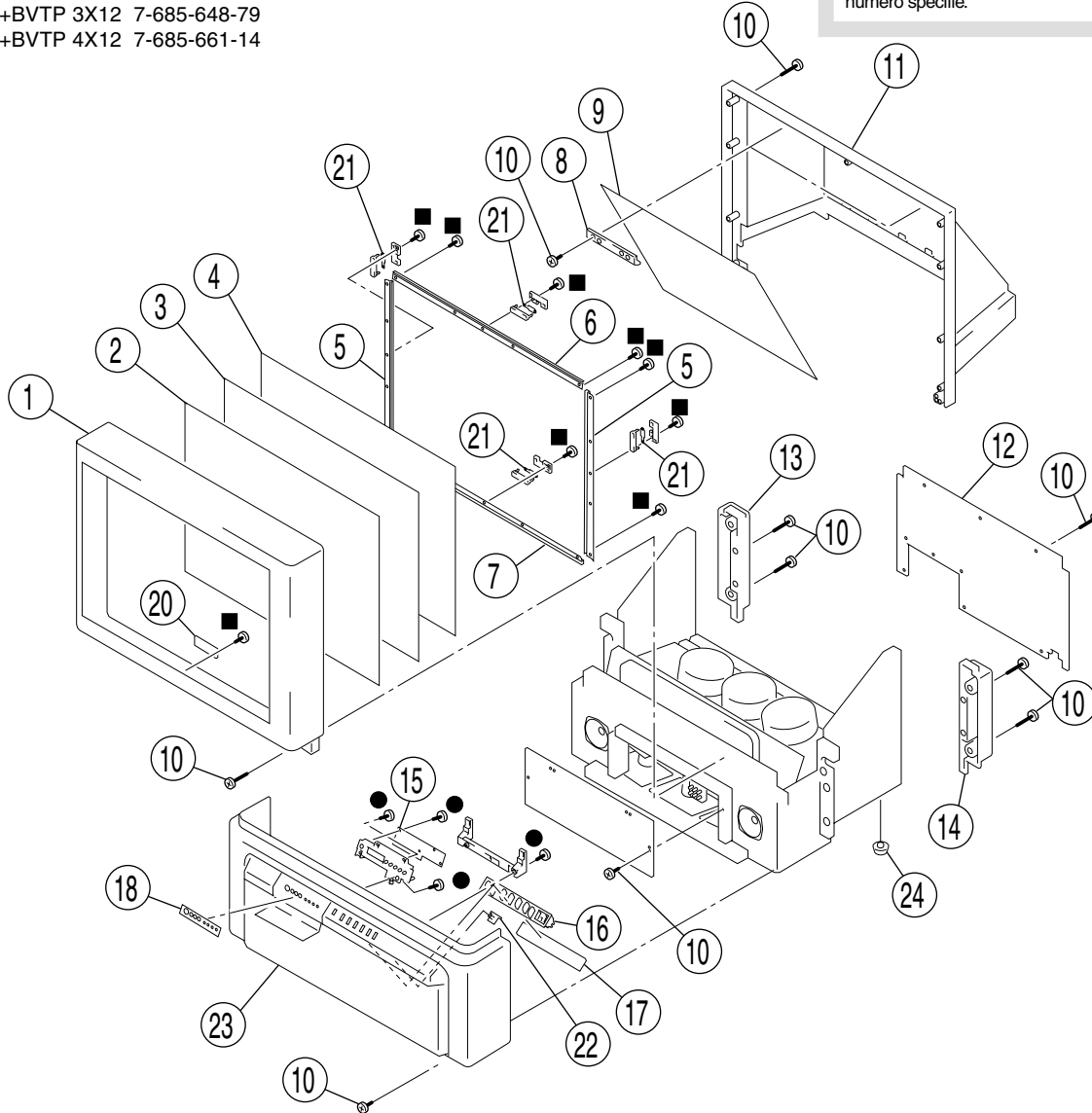

REF. NO.	PART NO.	DESCRIPTION	REMARK	REF. NO.	PART NO.	DESCRIPTION	REMARK
1	* X-4036-892-1	BEZNET ASSY		13	4-069-703-01	CAP(L), CONTROL	
2	4-070-286-11	SCREEN (43), CONTRAST		14	4-069-704-01	CAP(R), CONTROL	
3	4-070-284-11	PLATE(L), DIFFUSION		15	* A-1372-620-A	HB BOARD, COMPLETE	
4	4-070-285-11	PLATE(43F), DIFFUSION		16	4-069-681-21	BUTTON, MULTI	
5	* 4-070-332-31	HOLDER (L), SCREEN (NC)		17	* A-1372-619-A	HA BOARD, COMPLETE	
6	* 4-070-333-21	HOLDER (S), SCREEN (NC)		18	4-072-529-01	LABEL(2), SPEAKER GRILLE	
7	* 4-070-333-31	HOLDER (S), SCREEN (NC)		20	* A-1372-618-A	HC BOARD, COMPLETE	
8	* 4-069-686-01	HOLDER, MIRROR		21	* A-1390-933-A	S BOARD, COMPLETE	
9	4-077-051-01	MIRROR, REFLECTION (43T)		22	4-069-682-01	GUIDE, LED	
10	4-378-522-31	SCREW (4X20), TAPPING		23	* X-4036-893-2	PANEL ASSY, CONTROL	
11	* 4-069-696-03	COVER (43), MIRROR		24	4-057-611-01	FOOT	
12	* 4-071-387-02	BOARD, REAR					

7-2. COVER (KP-48S75)

- : +BVTP 3X12 7-685-648-79
- : +BVTP 4X12 7-685-661-14

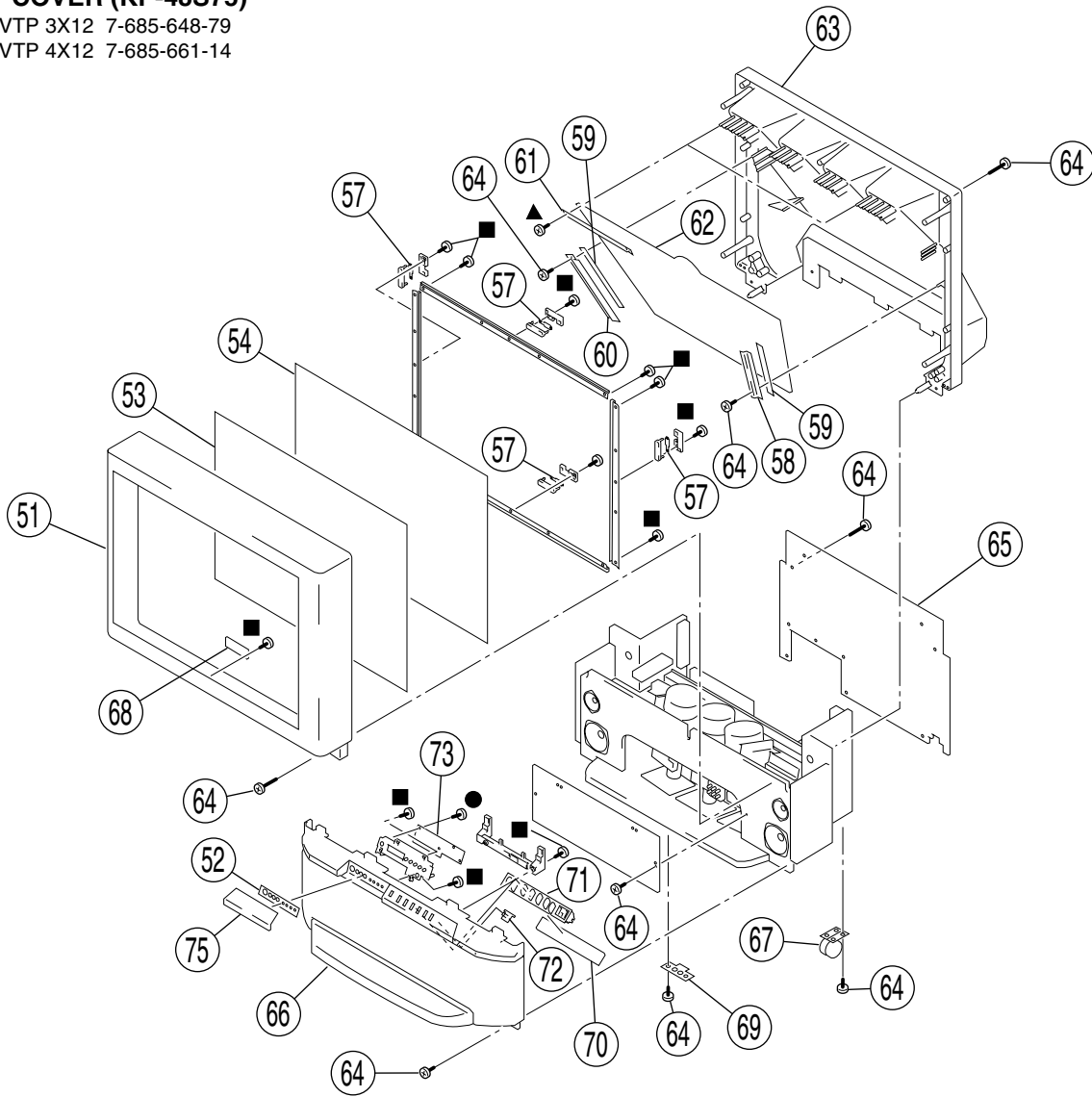

REF. NO.	PART NO.	DESCRIPTION	REMARK	REF. NO.	PART NO.	DESCRIPTION	REMARK
51	X-4036-838-1	BEZNET ASSY (48V)		64	4-378-522-31	SCREW (4X20), TAPPING	
52	4-072-529-01	LABEL(2), SPEAKER GRILLE		65	* 4-071-126-01	BOARD, REAR (48)	
53	4-070-280-11	PLATE (L), DIFFUSION		66	X-4036-756-1	GRILLE ASSY (53S), SPEAKER	75
54	4-058-455-11	PLATE (F), DIFFUSION		67	4-040-755-01	CASTER (DIA. 30)	
57	* A-1390-933-A	S BOARD, COMPLETE		68	* A-1372-618-A	HC BOARD, COMPLETE	
58	* 4-051-789-02	HOLDER, MIRSD (R)		69	4-048-175-01	FOOT, PLASTIC	
59	* 4-049-098-01	CUSHION		70	* A-1372-619-A	HA BOARD, COMPLETE	
60	* 4-051-790-02	HOLDER, MIRSD (L)		71	4-069-681-11	BUTTON, MULTI	
61	* 4-070-345-21	HOLDER (TOP), MIRROR		72	4-069-682-01	GUIDE, LED	
62	4-071-048-02	MIRROR (48), REFLECTION		73	* A-1372-620-A	HB BOARD, COMPLETE	
63	* 4-057-610-01	COVER, MIRROR		75	4-069-659-01	DOOR(S), CONTROL	

7-3. COVER (KP-53N77/53S75/61S75)

- : +BVTP 3X12 7-685-648-79
- : +BVTP 4X12 7-685-661-14

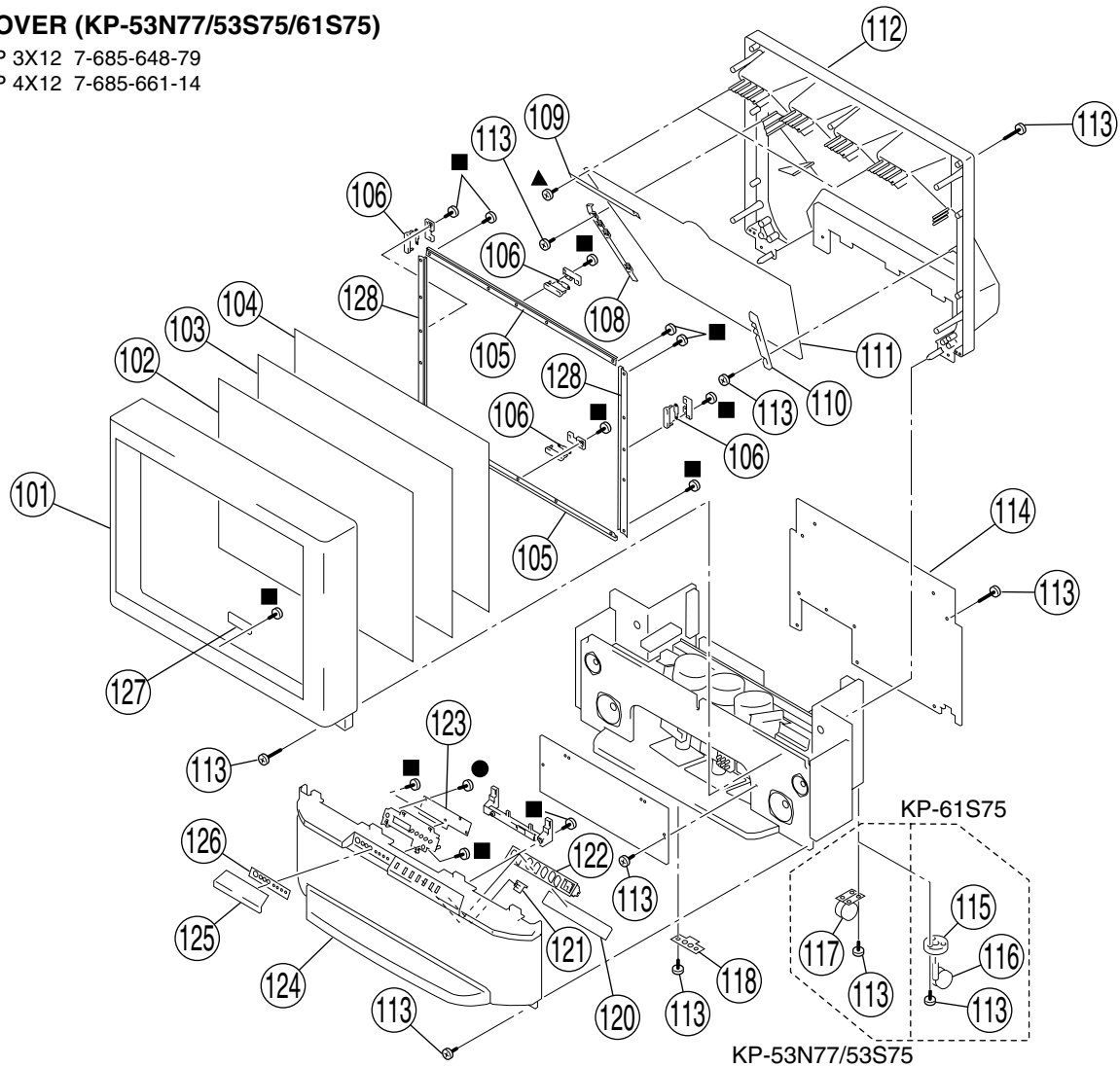

REF. NO.	PART NO.	DESCRIPTION	REMARK	REF. NO.	PART NO.	DESCRIPTION	REMARK
101	X-4036-755-1	BEZNET ASSY (53S) (53N77)		113	4-378-522-31	SCREW (4X20), TAPPING	
	X-4036-807-1	BEZNET ASSY (61V) (61S75)		114	* 4-070-342-01	BOARD (53), REAR (53N77/53S75)	
	X-4036-809-1	BEZNET ASSY (53V) (53S75)			* 4-070-920-02	BOARD, REAR (61S75)	
102	4-071-582-01	SCREEN (53), CONTRAST (53N77)		115	4-030-850-01	SOCKET, CASTER (61S75)	
103	4-070-281-11	PLATE (L), DIFFUSION (53S75)		116	4-039-546-01	CASTER (61S75)	
	4-070-283-11	PLATE (L), DIFFUSION (61S75)		117	4-040-755-01	CASTER (DIA. 30) (EXCEPT 61S75)	
	4-070-525-11	PLATE (L), DIFFUSION (53N77)		118	4-048-175-01	FOOT, PLASTIC	
104	4-066-082-11	PLATE (F), DIFFUSION (61S75)		120	* A-1372-619-A	HA BOARD, COMPLETE	
	4-070-602-11	PLATE (F), DIFFUSION (53N77,53S75)		121	4-069-682-01	GUIDE, LED	
105	* 4-070-328-11	HOLDER (L), SCREEN (YC) (53N77)		122	4-069-681-11	BUTTON, MULTI	
	* 4-070-331-11	HOLDER (L), SCREEN (NC) (53S75)		123	* A-1372-620-A	HB BOARD, COMPLETE	
	* 4-070-332-01	HOLDER (L), SCREEN (NC) (61S75)		124	X-4036-756-1	GRILLE ASSY (53S), SPEAKER (53S75)	125
106	* A-1390-933-A	S BOARD, COMPLETE			X-4036-875-1	PANEL ASSY, CONTROL (53S-STAR) (53N77)	125
108	* 4-069-687-01	HOLDER (LS), MIRROR (53N77,53S75)			* X-4036-889-1	GRILLE (61S) ASSY, SPEAKER (61S75)	125
	* 4-069-689-01	HOLDER (L), MIRROR (61S75)					
109	* 4-070-345-01	HOLDER (TOP), MIRROR (61S75)		125	4-069-659-01	DOOR (S), CONTROL (53S75,61S75)	
	* 4-070-345-11	HOLDER (TOP), MIRROR (53N77,53S75)			4-069-671-01	DOOR (V), CONTROL (53N77)	
110	* 4-069-688-01	HOLDER (RS), MIRROR (53N77,53S75)		126	4-072-529-01	LABEL(2), SPEAKER GRILLE	
	* 4-069-690-01	HOLDER (R), MIRROR (61S75)		127	* A-1372-618-A	HC BOARD, COMPLETE	
111	4-070-344-01	MIRROR, REFLECTION (53N77,53S75)		128	* 4-070-330-01	HOLDER (S), SCREEN (YC) (53N77)	
	4-070-922-01	MIRROR, REFLECTION (61S75)			* 4-070-333-01	HOLDER (S), SCREEN (NC) (53S75)	
112	* 4-069-694-01	COVER, MIRROR (53N77,53S75)			* 4-070-335-01	HOLDER (S), SCREEN (NC) (61S75)	
	* 4-070-922-01	COVER, MIRROR (61S75)					

Les composants identifiés par une trame et une marque \triangle sont critiques pour la sécurité. Ne les remplacer que par une pièce portant le numéro spécifié.

The components identified by shading and mark \triangle are critical for safety. Replace only with part number specified.

7-4. CHASSIS (KP-43T75)

● : +BVTP 3X12 7-685-648-79

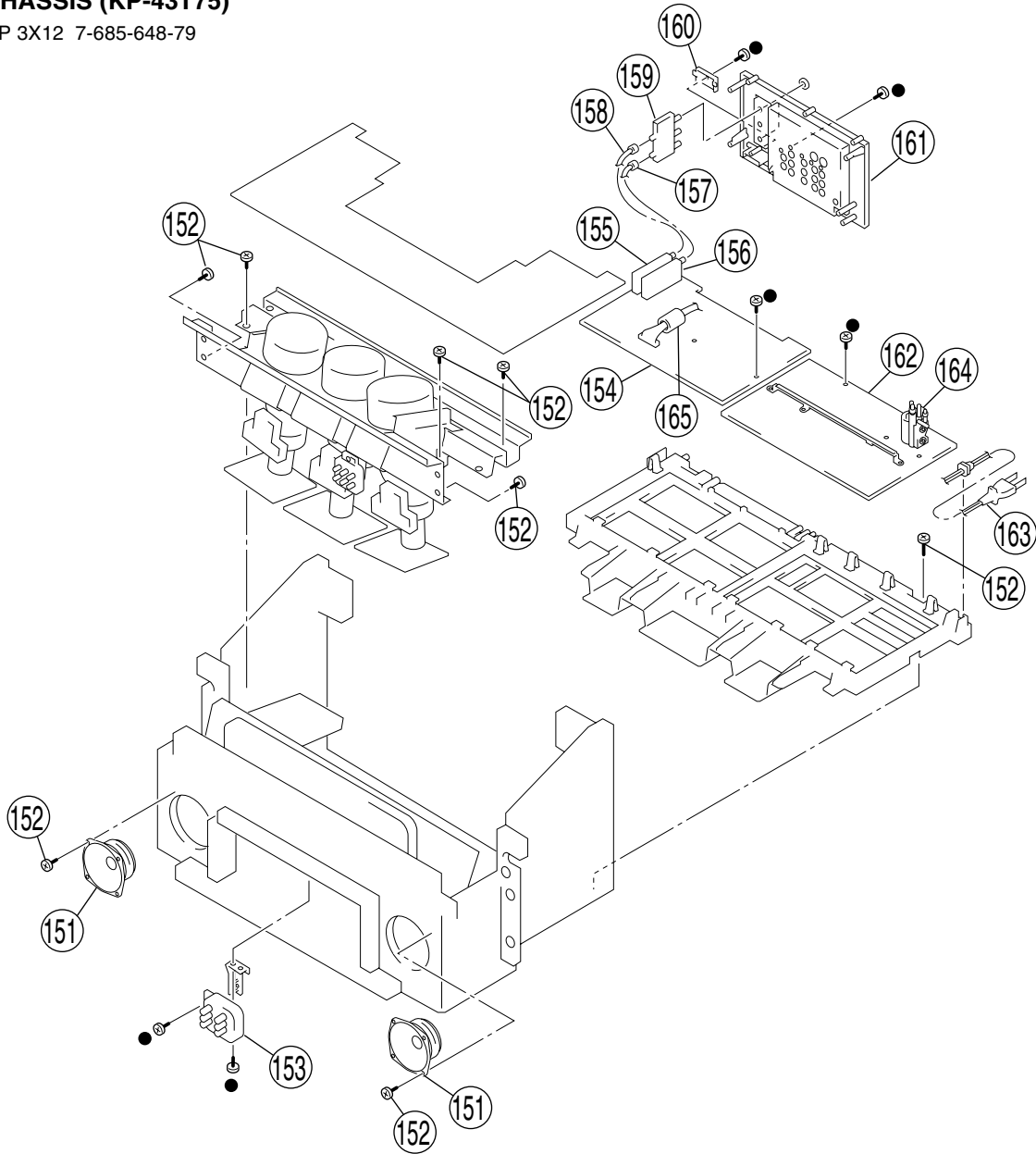

REF. NO.	PART NO.	DESCRIPTION	REMARK	REF. NO.	PART NO.	DESCRIPTION	REMARK
151	1-529-396-11	SPEAKER (10cm)		158	1-556-945-21	CABLE, P-P	
152	4-378-522-31	SCREW (4X20), TAPPING		159	\triangle 8-598-414-20	CHANGER, ANTENNA AS-2F	
153	\triangle 1-223-925-11	RESISTOR ASSY (HIGH-VOLTAGE) (FOCUS PACK)		160	4-069-675-01	CAP, TERMINAL BOARD	
154	* A-1298-864-A	A BOARD, COMPLETE		161	4-069-674-11	TERMINAL BOARD	
155	8-598-431-00	TUNER, FSS BTF-WA411 (TU151)		162	* A-1316-475-A	G BOARD, COMPLETE	
156	8-598-430-00	TUNER, FSS BTF-FA401 (TU152)		163	\triangle 1-790-001-11	CORD, AC POWER (WITH CONNECTOR)	
157	* 1-557-056-31	CABLE, P-P		164	\triangle 1-453-238-31	FLAYBACK TRANS ASSY (T504)	
				165	1-500-021-11	CLAMP, SLEEVE FERRITE	

Les composants identifiés par une trame et une marque Δ sont critiques pour la sécurité. Ne les remplacer que par une pièce portant le numéro spécifié.

The components identified by shading and mark Δ are critical for safety. Replace only with part number specified.

7-5. CHASSIS (EXCEPT KP-43T75)

● : +BVTP 3X12 7-685-648-79

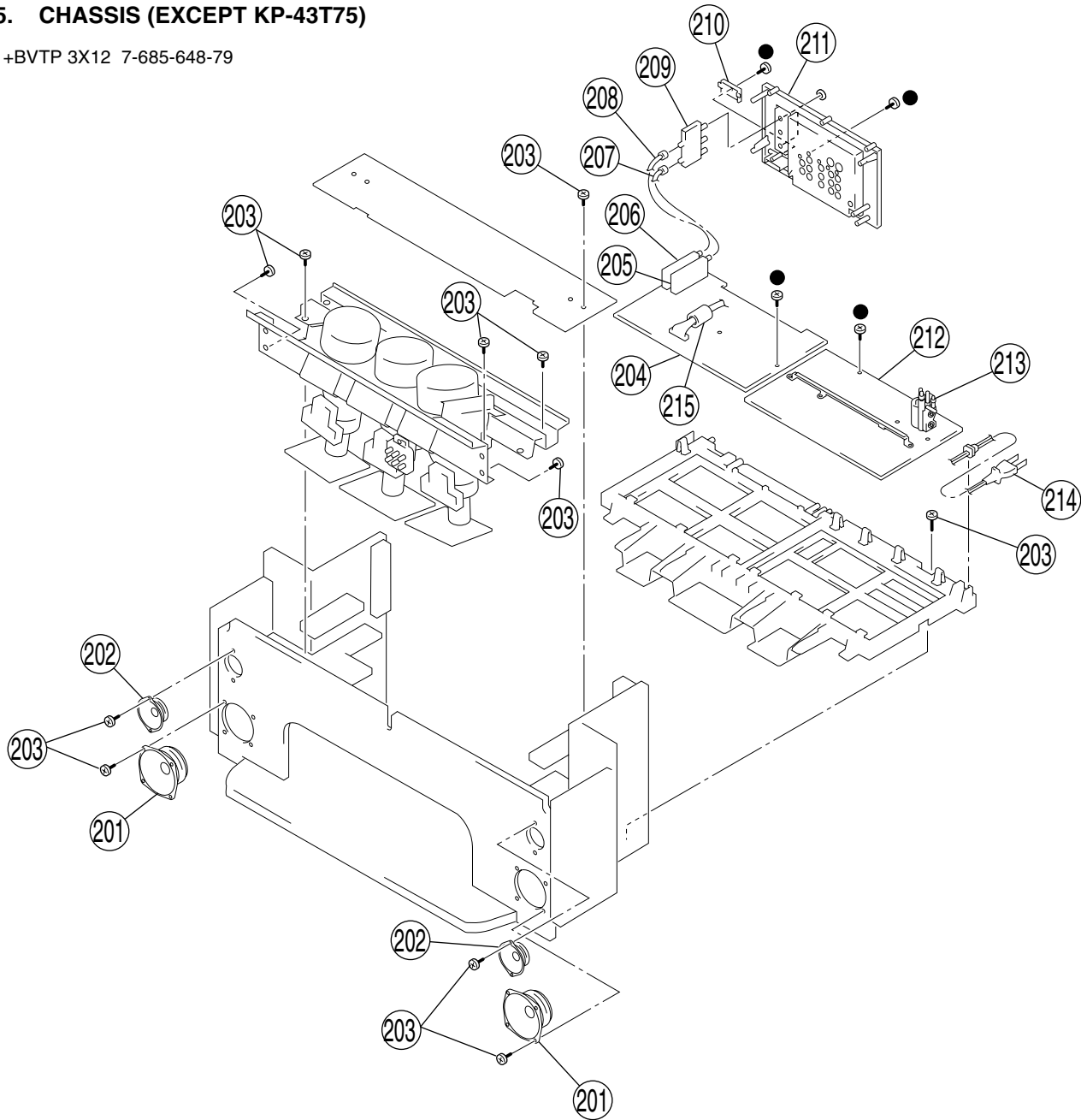

REF. NO.	PART NO.	DESCRIPTION	REMARK	REF. NO.	PART NO.	DESCRIPTION	REMARK
201	1-529-396-11	SPEAKER (10cm) (EXCEPT 53N77)		211	4-069-674-11	TERMINAL BOARD	
	1-529-401-11	SPEAKER (13cm) (53N77)		212	* A-1316-437-A	G BOARD, COMPLETE (53N77,53S75)	
202	1-529-403-11	SPEAKER (6.6cm) (53N77)			* A-1316-471-A	G BOARD, COMPLETE (48S75,61S75)	
203	4-378-522-31	SCREW (4X20), TAPPING			* A-1316-498-A	G BOARD, COMPLETE (61S75 Serial No. 9,500,001-)	
204	* A-1298-864-A	A BOARD, COMPLETE (EXCEPT 53N77)			* A-1316-499-A	G BOARD, COMPLETE (53S75 Serial No. 9,500,001-)	
	* A-1298-981-A	A BOARD, COMPLETE (53N77)		213	Δ 1-453-238-31	FLAYBACK TRANS ASSY (T504)	
205	8-598-430-00	TUNER, FSS BTF-FA401 (TU152)		214	Δ 1-790-001-11	CORD, AC POWER (WITH CONNECTOR) (48S75,61S75)	
206	8-598-431-00	TUNER, FSS BTF-WA411 (TU151)			Δ 1-790-130-11	CORD, AC POWER (WITH CONNECTOR) (53N77,53S75)	
207	* 1-557-056-31	CABLE, P-P		215	1-500-021-11	CLAMP, SLEEVE FERRITE	
208	1-556-945-21	CABLE, P-P					
209	Δ 8-598-414-20	CHANGER, ANTENNA AS-2F					
210	4-069-675-01	CAP, TERMINAL BOARD					

Les composants identifiés par une trame et une marque \triangle sont critiques pour la sécurité. Ne les remplacer que par une pièce portant le numéro spécifié.

The components identified by shading and mark \triangle are critical for safety. Replace only with part number specified.

7-6. PICTURE TUBE

- : +BVTP 3X12 7-685-648-79
- : +BVTP 4X12 7-685-661-14

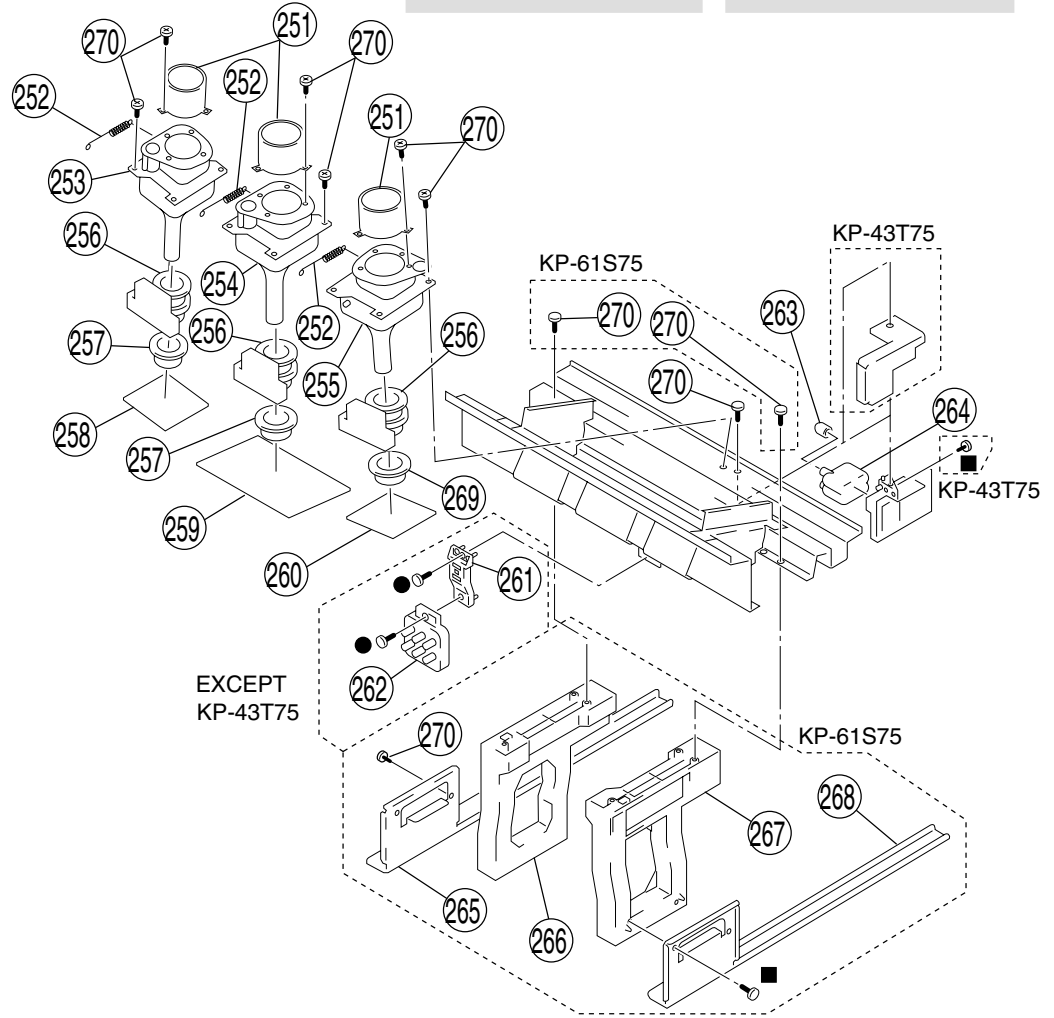

REF. NO.	PART NO.	DESCRIPTION	REMARK
251	4-040-131-21	LENS (LINNIT POINT 6) (61S75)	
	4-056-258-11	LENS (DELTA 78) (EXCEPT 61S75)	
252	4-057-007-01	SPRING, TENSION	
		(53S75/61S75 Serial No. 9,500,001-)	
253	\triangle 8-733-571-15	CRT 07MXC2(R)(HEATER) (43T75)	
	\triangle 8-733-572-15	CRT 07MXC3(R)(HEATER)	
		(48S75,53N77,53S75)	
	\triangle 8-733-573-15	CRT 07MXC4(R)(HEATER) (61S75)	
	\triangle A-1501-521-A	COUPLER ASSY, CRT (R)	
		(61S75 Serial No. 9,500,001-)	
	\triangle A-1501-526-A	COUPLER ASSY, CRT (R)	
		(53S75 Serial No. 9,500,001-)	
254	\triangle 8-733-570-15	CRT 07MXC2(G)(HEATER)	
		(EXCEPT 53S75/61S75 Serial No. 9,500,001-)	
	\triangle A-1501-522-A	COUPLER ASSY, CRT (G)	
		(53S75/61S75 Serial No. 9,500,001-)	
255	\triangle 8-733-574-15	CRT 07MAC2(B)(HEATER) (43T75)	
	\triangle 8-733-575-15	CRT 07MAC3(B)(HEATER)	
		(48S75,53N77,53S75)	
	\triangle 8-733-576-15	CRT 07MAC4(B)(HEATER) (61S75)	
	\triangle A-1501-520-A	COUPLER ASSY, CRT (B)	
		(61S75 Serial No. 9,500,001-)	
	\triangle A-1501-527-A	COUPLER ASSY, CRT (B)	
		(53S75 Serial No. 9,500,001-)	

REF. NO.	PART NO.	DESCRIPTION	REMARK
256	\triangle 1-451-496-11	DEFLECTION YOKE	
		(EXCEPT 53S75/61S75 Serial No. 9,500,001-)	
	\triangle 1-451-496-21	DEFLECTION YOKE	
		(53S75/61S75 Serial No. 9,500,001-)	
257	\triangle 1-451-469-21	COIL ASSY, VM	
		(53S75/61S75 Serial No. 9,500,001-)	
	\triangle 1-452-790-21	NECK ASSY	
		(EXCEPT 53S75/61S75 Serial No. 9,500,001-)	
258	* A-1331-922-A	CR BOARD, COMPLETE	
259	* A-1331-923-A	CG BOARD, COMPLETE	
260	* A-1331-924-A	CB BOARD, COMPLETE	
261	* 4-063-403-01	BRACKET, FOCUS PACK (EXCEPT 43T75)	
262	\triangle 1-223-925-11	RESISTOR ASSY (HIGH-VOLTAGE)	
		(FOCUS PACK) (EXCEPT 43T75)	
263	4-373-137-01	CAP(Z), RUBBER (43T70)	
264	\triangle 8-598-955-30	BLOCK ASSY, HIGH-VOLTAGE	
265	4-070-916-01	STAY (R), CHASSIS (61S75)	
266	4-069-677-02	BOARD (L), SIDE (61S75)	
267	4-069-678-02	BOARD (R), SIDE (61S75)	
268	4-070-917-02	STAY (L), CHASSIS (61S75)	
269	\triangle 1-451-469-21	COIL ASSY, VM	
		(53S75/61S75 Serial No. 9,500,001-)	
	\triangle 1-452-909-31	MAGNET ASSY, 4 POLE	
		(EXCEPT 53S75/61S75 Serial No. 9,500,001-)	
270	4-052-894-01	SCREW (4X20), HEAD TAPPING	



SECTION 8 ELECTRICAL PARTS LIST

The components identified by shading and mark \triangle are critical for safety. Replace only with part number specified.

Les composants identifiés par une trame et une marque \triangle sont critiques pour la sécurité. Ne les remplacer que par une pièce portant le numéro spécifié.

When indicating parts by reference number, please include the board name.

- The components identified by in \square this manual have been carefully factory-selected for each set in order to satisfy regulations regarding X-ray radiation. Should replacement be required, replace only with the value originally used.
- Items marked " * " are not stocked since they are seldom required for routine service. Some delay should be anticipated when ordering these items.
- All variable and adjustable resistors have characteristic curve B, unless otherwise noted.
- CAPACITORS
PF : $\mu\mu$ F
- There are some cases the reference number on one board overlaps on the other board. Therefore, when ordering parts by the reference number, please include the board name.

- RESISTORS
- All resistors are in ohms
 - F : nonflammable

REF. NO.	PART NO.	DESCRIPTION	REMARK	REF. NO.	PART NO.	DESCRIPTION	REMARK
* A-1298-864-A	A BOARD, COMPLETE (EXCEPT 53N77)			C128	1-128-551-11	ELECT	22 μ F 20% 25V
*****				C151	1-126-935-11	ELECT	470 μ F 20% 16V
* A-1298-981-A	A BOARD, COMPLETE (53N77)			C152	1-163-021-91	CERAMIC CHIP	0.01 μ F 10% 50V
*****				C153	1-163-021-91	CERAMIC CHIP	0.01 μ F 10% 50V
4-382-854-11	SCREW (M3X10), P, SW (+)			C154	1-163-021-91	CERAMIC CHIP	0.01 μ F 10% 50V
<CAPACITOR>				C155	1-128-551-11	ELECT	22 μ F 20% 25V
C002	1-163-259-91	CERAMIC CHIP	220pF 5% 50V	C156	1-126-933-11	ELECT	100 μ F 20% 16V
C003	1-164-004-11	CERAMIC CHIP	0.1 μ F 10% 25V	C157	1-163-021-91	CERAMIC CHIP	0.01 μ F 10% 50V
C004	1-163-809-11	CERAMIC CHIP	0.047 μ F 10% 25V	C159	1-164-161-11	CERAMIC CHIP	0.0022 μ F 10% 50V
C005	1-126-935-11	ELECT	470 μ F 20% 6.3V	C161	1-126-968-11	ELECT	100 μ F 20% 50V
C006	1-126-960-11	ELECT	1 μ F 20% 50V	C162	1-126-960-11	ELECT	1 μ F 20% 50V
C015	1-163-259-91	CERAMIC CHIP	220pF 5% 50V	C163	1-126-959-11	ELECT	0.47 μ F 20% 50V
C016	1-163-809-11	CERAMIC CHIP	0.047 μ F 10% 25V	C164	1-128-551-11	ELECT	22 μ F 20% 25V
C039	1-163-021-91	CERAMIC CHIP	0.01 μ F 10% 50V	C165	1-128-551-11	ELECT	22 μ F 20% 25V
C040	1-126-916-11	ELECT	1000 μ F 20% 6.3V	C166	1-163-021-91	CERAMIC CHIP	0.01 μ F 10% 50V
C041	1-163-229-11	CERAMIC CHIP	12pF 5% 50V	C167	1-126-935-11	ELECT	470 μ F 20% 16V
C042	1-126-960-11	ELECT	1 μ F 20% 50V	C168	1-163-021-91	CERAMIC CHIP	0.01 μ F 10% 50V
C044	1-163-231-11	CERAMIC CHIP	15pF 5% 50V	C170	1-163-021-91	CERAMIC CHIP	0.01 μ F 10% 50V
C072	1-163-021-91	CERAMIC CHIP	0.01 μ F 10% 50V	C171	1-126-933-11	ELECT	100 μ F 20% 16V
C080	1-163-227-11	CERAMIC CHIP	10pF 0.50pF50V	C172	1-126-964-11	ELECT	10 μ F 20% 50V
C081	1-163-227-11	CERAMIC CHIP	10pF 0.50pF50V	C173	1-163-021-91	CERAMIC CHIP	0.01 μ F 10% 50V
C082	1-163-227-11	CERAMIC CHIP	10pF 0.50pF50V	C174	1-126-933-11	ELECT	100 μ F 20% 16V
C085	1-163-021-91	CERAMIC CHIP	0.01 μ F 10% 50V	C175	1-128-551-11	ELECT	22 μ F 20% 25V
C086	1-163-229-11	CERAMIC CHIP	12pF 5% 50V	C176	1-164-161-11	CERAMIC CHIP	0.0022 μ F 10% 50V
C087	1-126-964-11	ELECT	10 μ F 20% 50V	C177	1-126-959-11	ELECT	0.47 μ F 20% 50V
C091	1-163-227-11	CERAMIC CHIP	10pF 0.50pF50V	C178	1-126-960-11	ELECT	1 μ F 20% 50V
C093	1-126-933-11	ELECT	100 μ F 20% 16V	C179	1-163-021-91	CERAMIC CHIP	0.01 μ F 10% 50V
C094	1-164-004-11	CERAMIC CHIP	0.1 μ F 10% 25V	C180	1-163-021-91	CERAMIC CHIP	0.01 μ F 10% 50V
C098	1-163-227-11	CERAMIC CHIP	10pF 0.50pF50V	C276	1-163-251-11	CERAMIC CHIP	100pF 5% 50V
C099	1-163-227-11	CERAMIC CHIP	10pF 0.50pF50V	C277	1-126-959-11	ELECT	0.47 μ F 20% 50V
C100	1-163-227-11	CERAMIC CHIP	10pF 0.50pF50V	C279	1-126-959-11	ELECT	0.47 μ F 20% 50V
C101	1-163-021-91	CERAMIC CHIP	0.01 μ F 10% 50V	C280	1-163-251-11	CERAMIC CHIP	100pF 5% 50V
C102	1-163-239-11	CERAMIC CHIP	33pF 5% 50V	C281	1-130-495-00	MYLAR	0.1 μ F 5% 50V
C103	1-163-239-11	CERAMIC CHIP	33pF 5% 50V	C282	1-130-495-00	MYLAR	0.1 μ F 5% 50V
C104	1-163-227-11	CERAMIC CHIP	10pF 0.50pF50V	C283	1-130-495-00	MYLAR	0.1 μ F 5% 50V
C105	1-163-227-11	CERAMIC CHIP	10pF 0.50pF50V	C284	1-163-021-91	CERAMIC CHIP	0.01 μ F 10% 50V
C106	1-163-227-11	CERAMIC CHIP	10pF 0.50pF50V	C285	1-163-021-91	CERAMIC CHIP	0.01 μ F 10% 50V
C107	1-128-551-11	ELECT	22 μ F 20% 25V	C286	1-163-021-91	CERAMIC CHIP	0.01 μ F 10% 50V
C126	1-128-551-11	ELECT	22 μ F 20% 25V	C287	1-126-964-11	ELECT	10 μ F 20% 50V
				C288	1-130-495-00	MYLAR	0.1 μ F 5% 50V
				C289	1-137-581-11	FILM	0.1 μ F 5% 100V



REF. NO.	PART NO.	DESCRIPTION	REMARK	REF. NO.	PART NO.	DESCRIPTION	REMARK
C290	1-126-935-11	ELECT	470µF 20% 16V	C448	1-130-471-00	MYLAR	0.001µF 5% 50V
C291	1-163-021-91	CERAMIC CHIP	0.01µF 10% 50V	C449	1-164-004-11	CERAMIC CHIP	0.1µF 10% 25V
C293	1-164-182-11	CERAMIC CHIP	0.0033µF 10% 50V	C450	1-126-963-11	ELECT	4.7µF 20% 50V
C294	1-130-495-00	MYLAR	0.1µF 5% 50V	C451	1-126-933-11	ELECT	100µF 20% 16V
C296	1-126-961-11	ELECT	2.2µF 20% 50V	C453	1-164-004-11	CERAMIC CHIP	0.1µF 10% 25V
C297	1-163-251-11	CERAMIC CHIP	100pF 5% 50V	C454	1-130-489-00	MYLAR	0.033µF 5% 50V
C299	1-126-959-11	ELECT	0.47µF 20% 50V	C456	1-126-933-11	ELECT	100µF 20% 16V
C300	1-164-004-11	CERAMIC CHIP	0.1µF 10% 25V	C457	1-126-934-11	ELECT	220µF 20% 16V
C301	1-164-004-11	CERAMIC CHIP	0.1µF 10% 25V	C458	1-164-004-11	CERAMIC CHIP	0.1µF 10% 25V
C302	1-164-004-11	CERAMIC CHIP	0.1µF 10% 25V	C459	1-164-004-11	CERAMIC CHIP	0.1µF 10% 25V
C303	1-126-933-11	ELECT	100µF 20% 16V	C460	1-126-943-11	ELECT	2200µF 20% 25V
C304	1-163-021-91	CERAMIC CHIP	0.01µF 10% 50V	C461	1-126-943-11	ELECT	2200µF 20% 25V
C305	1-163-017-00	CERAMIC CHIP	0.0047µF 10% 50V	C462	1-126-961-11	ELECT	2.2µF 20% 50V
C306	1-126-959-11	ELECT	0.47µF 20% 50V	C463	1-126-961-11	ELECT	2.2µF 20% 50V
C307	1-126-959-11	ELECT	0.47µF 20% 50V	C464	1-126-933-11	ELECT	100µF 20% 16V
C308	1-126-963-11	ELECT	4.7µF 20% 50V	C465	1-128-551-11	ELECT	22µF 20% 25V
C309	1-163-133-00	CERAMIC CHIP	470pF 5% 50V	C466	1-128-551-11	ELECT	22µF 20% 25V
C310	1-163-229-11	CERAMIC CHIP	12pF 5% 50V	C467	1-104-664-11	ELECT	47µF 20% 25V
C311	1-126-960-11	ELECT	1µF 20% 50V	C468	1-126-963-11	ELECT	4.7µF 20% 50V
C312	1-115-419-11	CERAMIC CHIP	3300pF 5% 25V	C469	1-128-551-11	ELECT	22µF 20% 25V
C313	1-163-259-91	CERAMIC CHIP	220pF 5% 50V	C470	1-104-664-11	ELECT	47µF 20% 25V
C314	1-128-551-11	ELECT	22µF 20% 25V	C473	1-104-665-11	ELECT	100µF 20% 25V
C315	1-163-113-00	CERAMIC CHIP	68pF 5% 50V (53N77)	C474	1-130-495-00	MYLAR	0.1µF 5% 50V
C315	1-163-245-11	CERAMIC CHIP	56pF 5% 50V (EXCEPT 53N77)	C475	1-130-495-00	MYLAR	0.1µF 5% 50V
C316	1-163-275-11	CERAMIC CHIP	0.001µF 5% 50V	C476	1-130-495-00	MYLAR	0.1µF 5% 50V
C317	1-104-664-11	ELECT	47µF 20% 16V	C477	1-130-495-00	MYLAR	0.1µF 5% 50V
C318	1-126-933-11	ELECT	100µF 20% 16V	C681	1-128-551-11	ELECT	22µF 20% 25V
C319	1-126-964-11	ELECT	10µF 20% 50V	C682	1-163-021-91	CERAMIC CHIP	0.01µF 10% 50V
C320	1-126-934-11	ELECT	220µF 20% 16V	C683	1-126-935-11	ELECT	470µF 20% 16V
C321	1-163-021-91	CERAMIC CHIP	0.01µF 10% 50V	C684	1-126-933-11	ELECT	100µF 20% 16V
C323	1-164-004-11	CERAMIC CHIP	0.1µF 10% 25V	C685	1-163-021-91	CERAMIC CHIP	0.01µF 10% 50V
C324	1-163-021-91	CERAMIC CHIP	0.01µF 10% 50V	C686	1-163-021-91	CERAMIC CHIP	0.01µF 10% 50V
C325	1-126-964-11	ELECT	10µF 20% 50V	C687	1-128-551-11	ELECT	22µF 20% 25V
C326	1-104-664-11	ELECT	47µF 20% 25V	C688	1-163-021-91	CERAMIC CHIP	0.01µF 10% 50V
C327	1-164-004-11	CERAMIC CHIP	0.1µF 10% 25V	C801	1-163-143-00	CERAMIC CHIP	0.0012µF 5% 50V
C328	1-163-021-91	CERAMIC CHIP	0.01µF 10% 50V	C802	1-163-016-00	CERAMIC CHIP	0.0039µF 10% 50V
C329	1-128-551-11	ELECT	22µF 20% 25V	C803	1-163-016-00	CERAMIC CHIP	0.0039µF 10% 50V
C330	1-128-551-11	ELECT	22µF 20% 25V	C804	1-163-038-91	CERAMIC CHIP	0.1µF 25V
C331	1-128-551-11	ELECT	22µF 20% 25V	C805	1-163-038-91	CERAMIC CHIP	0.1µF 25V
C332	1-128-551-11	ELECT	22µF 20% 25V	C806	1-104-664-11	ELECT	47µF 20% 25V
C418	1-126-964-11	ELECT	10µF 20% 50V	C807	1-163-038-91	CERAMIC CHIP	0.1µF 25V
C427	1-126-964-11	ELECT	10µF 20% 50V	C808	1-163-016-00	CERAMIC CHIP	0.0039µF 10% 50V
C433	1-126-963-11	ELECT	4.7µF 20% 50V	C809	1-163-016-00	CERAMIC CHIP	0.0039µF 10% 50V
C437	1-130-489-00	MYLAR	0.033µF 5% 50V	C810	1-163-038-91	CERAMIC CHIP	0.1µF 25V
C438	1-104-664-11	ELECT	47µF 20% 25V	C811	1-104-664-11	ELECT	47µF 20% 25V
C439	1-126-960-11	ELECT	1µF 20% 50V	C812	1-163-038-91	CERAMIC CHIP	0.1µF 25V
C440	1-126-963-11	ELECT	4.7µF 20% 50V	C813	1-104-664-11	ELECT	47µF 20% 25V
C441	1-130-477-00	MYLAR	0.0033µF 5% 50V	C814	1-163-259-91	CERAMIC CHIP	220pF 5% 50V
C442	1-130-489-00	MYLAR	0.033µF 5% 50V	C815	1-163-259-91	CERAMIC CHIP	220pF 5% 50V
C443	1-130-471-00	MYLAR	0.001µF 5% 50V	C816	1-163-038-91	CERAMIC CHIP	0.1µF 25V
C444	1-126-963-11	ELECT	4.7µF 20% 50V	C817	1-163-038-91	CERAMIC CHIP	0.1µF 25V
C445	1-126-963-11	ELECT	4.7µF 20% 50V	C818	1-163-259-91	CERAMIC CHIP	220pF 5% 50V
C446	1-130-477-00	MYLAR	0.0033µF 5% 50V	C819	1-163-259-91	CERAMIC CHIP	220pF 5% 50V
C447	1-130-489-00	MYLAR	0.033µF 5% 50V	C820	1-163-038-91	CERAMIC CHIP	0.1µF 25V
				C821	1-104-664-11	ELECT	47µF 20% 25V
				C822	1-163-038-91	CERAMIC CHIP	0.1µF 25V



REF. NO.	PART NO.	DESCRIPTION		REMARK	REF. NO.	PART NO.	DESCRIPTION		REMARK
C823	1-104-664-11	ELECT	47µF	20% 25V	C893	1-163-038-91	CERAMIC CHIP	0.1µF	25V
C824	1-164-004-11	CERAMIC CHIP	0.1µF	10% 25V	C894	1-104-664-11	ELECT	47µF	20% 25V
C825	1-163-038-91	CERAMIC CHIP	0.1µF	25V	C897	1-163-038-91	CERAMIC CHIP	0.1µF	25V
C826	1-107-823-11	CERAMIC CHIP	0.47µF	10% 16V	C898	1-126-934-11	ELECT	220µF	20% 16V
C827	1-107-823-11	CERAMIC CHIP	0.47µF	10% 16V	C899	1-163-222-11	CERAMIC CHIP	5pF	0.25pF 50V
C828	1-107-823-11	CERAMIC CHIP	0.47µF	10% 16V	C900	1-163-222-11	CERAMIC CHIP	5pF	0.25pF 50V
C829	1-107-823-11	CERAMIC CHIP	0.47µF	10% 16V	C901	1-163-222-11	CERAMIC CHIP	5pF	0.25pF 50V
C830	1-163-038-91	CERAMIC CHIP	0.1µF	25V	C902	1-163-222-11	CERAMIC CHIP	5pF	0.25pF 50V
C831	1-104-664-11	ELECT	47µF	20% 25V	C903	1-163-222-11	CERAMIC CHIP	5pF	0.25pF 50V
C832	1-163-235-11	CERAMIC CHIP	22pF	5% 50V	C904	1-163-222-11	CERAMIC CHIP	5pF	0.25pF 50V
C833	1-104-664-11	ELECT	47µF	20% 25V	C905	1-163-222-11	CERAMIC CHIP	5pF	0.25pF 50V
C834	1-164-161-11	CERAMIC CHIP	0.0022µF	10% 50V	C906	1-163-222-11	CERAMIC CHIP	5pF	0.25pF 50V
C835	1-163-235-11	CERAMIC CHIP	22pF	5% 50V	C907	1-163-222-11	CERAMIC CHIP	5pF	0.25pF 50V
C842	1-164-004-11	CERAMIC CHIP	0.1µF	10% 25V	C908	1-163-222-11	CERAMIC CHIP	5pF	0.25pF 50V
C843	1-104-664-11	ELECT	47µF	20% 25V	C909	1-163-222-11	CERAMIC CHIP	5pF	0.25pF 50V
C845	1-163-038-91	CERAMIC CHIP	0.1µF	25V	C910	1-163-222-11	CERAMIC CHIP	5pF	0.25pF 50V
C848	1-163-038-91	CERAMIC CHIP	0.1µF	25V	C911	1-164-690-91	CERAMIC CHIP	0.0022µF	5% 50V
C849	1-104-664-11	ELECT	47µF	20% 25V	C912	1-104-664-11	ELECT	47µF	20% 25V
C850	1-104-664-11	ELECT	47µF	20% 25V	C913	1-104-664-11	ELECT	47µF	20% 25V
C851	1-163-038-91	CERAMIC CHIP	0.1µF	25V	C914	1-104-664-11	ELECT	47µF	20% 25V
C852	1-104-664-11	ELECT	47µF	20% 25V	C915	1-104-664-11	ELECT	47µF	20% 25V
C853	1-163-038-91	CERAMIC CHIP	0.1µF	25V	C916	1-104-664-11	ELECT	47µF	20% 25V
C854	1-163-038-91	CERAMIC CHIP	0.1µF	25V	C917	1-104-664-11	ELECT	47µF	20% 25V
C855	1-163-001-11	CERAMIC CHIP	220pF	10% 50V	C918	1-163-275-11	CERAMIC CHIP	0.001µF	5% 50V
C856	1-104-664-11	ELECT	47µF	20% 25V	C919	1-163-275-11	CERAMIC CHIP	0.001µF	5% 50V
C858	1-163-038-91	CERAMIC CHIP	0.1µF	25V	C920	1-163-275-11	CERAMIC CHIP	0.001µF	5% 50V
C862	1-164-004-11	CERAMIC CHIP	0.1µF	10% 25V	C921	1-163-275-11	CERAMIC CHIP	0.001µF	5% 50V
C863	1-163-231-11	CERAMIC CHIP	15pF	5% 50V	C922	1-163-275-11	CERAMIC CHIP	0.001µF	5% 50V
C864	1-163-239-11	CERAMIC CHIP	33pF	5% 50V	C923	1-163-275-11	CERAMIC CHIP	0.001µF	5% 50V
C865	1-164-004-11	CERAMIC CHIP	0.1µF	10% 25V	C926	1-163-021-91	CERAMIC CHIP	0.01µF	10% 50V
C866	1-163-038-91	CERAMIC CHIP	0.1µF	25V	C927	1-163-038-91	CERAMIC CHIP	0.1µF	25V
C867	1-109-982-11	CERAMIC CHIP	1µF	10% 10V	C928	1-163-038-91	CERAMIC CHIP	0.1µF	25V
C868	1-163-038-91	CERAMIC CHIP	0.1µF	25V	C929	1-163-038-91	CERAMIC CHIP	0.1µF	25V
C869	1-163-021-91	CERAMIC CHIP	0.01µF	10% 50V	C930	1-163-038-91	CERAMIC CHIP	0.1µF	25V
C870	1-104-664-11	ELECT	47µF	20% 25V	C931	1-163-038-91	CERAMIC CHIP	0.1µF	25V
C871	1-126-963-11	ELECT	4.7µF	20% 50V	C932	1-163-038-91	CERAMIC CHIP	0.1µF	25V
C872	1-163-239-11	CERAMIC CHIP	33pF	5% 50V	C933	1-163-017-00	CERAMIC CHIP	0.0047µF	10% 50V
C873	1-163-038-91	CERAMIC CHIP	0.1µF	25V	C934	1-163-017-00	CERAMIC CHIP	0.0047µF	10% 50V
C875	1-104-664-11	ELECT	47µF	20% 25V	C935	1-163-017-00	CERAMIC CHIP	0.0047µF	10% 50V
C876	1-163-038-91	CERAMIC CHIP	0.1µF	25V	C936	1-163-017-00	CERAMIC CHIP	0.0047µF	10% 50V
C877	1-104-664-11	ELECT	47µF	20% 25V	C937	1-163-017-00	CERAMIC CHIP	0.0047µF	10% 50V
C878	1-104-664-11	ELECT	47µF	20% 25V	C938	1-163-017-00	CERAMIC CHIP	0.0047µF	10% 50V
C879	1-104-664-11	ELECT	47µF	20% 25V	C951	1-163-019-00	CERAMIC CHIP	0.0068µF	10% 50V
C880	1-163-038-91	CERAMIC CHIP	0.1µF	25V	C952	1-163-019-00	CERAMIC CHIP	0.0068µF	10% 50V
C881	1-163-038-91	CERAMIC CHIP	0.1µF	25V	C953	1-163-019-00	CERAMIC CHIP	0.0068µF	10% 50V
C882	1-163-038-91	CERAMIC CHIP	0.1µF	25V	C954	1-163-019-00	CERAMIC CHIP	0.0068µF	10% 50V
C883	1-104-664-11	ELECT	47µF	20% 25V	C955	1-163-019-00	CERAMIC CHIP	0.0068µF	10% 50V
C884	1-104-664-11	ELECT	47µF	20% 25V	C956	1-163-019-00	CERAMIC CHIP	0.0068µF	10% 50V
C885	1-104-664-11	ELECT	47µF	20% 25V	C957	1-163-038-91	CERAMIC CHIP	0.1µF	25V
C886	1-104-664-11	ELECT	47µF	20% 25V	C958	1-163-038-91	CERAMIC CHIP	0.1µF	25V
C887	1-104-664-11	ELECT	47µF	20% 25V	C959	1-163-038-91	CERAMIC CHIP	0.1µF	25V
C888	1-104-664-11	ELECT	47µF	20% 25V	C960	1-163-038-91	CERAMIC CHIP	0.1µF	25V
C889	1-163-038-91	CERAMIC CHIP	0.1µF	25V	C961	1-163-038-91	CERAMIC CHIP	0.1µF	25V
C890	1-104-664-11	ELECT	47µF	20% 25V	C962	1-163-038-91	CERAMIC CHIP	0.1µF	25V
C891	1-163-038-91	CERAMIC CHIP	0.1µF	25V	C963	1-104-664-11	ELECT	47µF	20% 25V
C892	1-104-664-11	ELECT	47µF	20% 25V	C964	1-104-664-11	ELECT	47µF	20% 25V



REF. NO.	PART NO.	DESCRIPTION	REMARK	REF. NO.	PART NO.	DESCRIPTION	REMARK
C965	1-104-664-11	ELECT	47μF 20% 25V	C1701	1-128-551-11	ELECT	22μF 20% 25V
C966	1-104-664-11	ELECT	47μF 20% 25V	C1702	1-163-021-91	CERAMIC CHIP	0.01μF 10% 50V
C967	1-104-664-11	ELECT	47μF 20% 25V	C1703	1-163-021-91	CERAMIC CHIP	0.01μF 10% 50V
C968	1-104-664-11	ELECT	47μF 20% 25V	C1704	1-126-933-11	ELECT	100μF 20% 16V
C969	1-163-038-91	CERAMIC CHIP	0.1μF 25V	C1705	1-163-021-91	CERAMIC CHIP	0.01μF 10% 50V
C970	1-163-038-91	CERAMIC CHIP	0.1μF 25V	C1706	1-163-021-91	CERAMIC CHIP	0.01μF 10% 50V
C971	1-104-664-11	ELECT	47μF 20% 25V	C1707	1-128-551-11	ELECT	22μF 20% 25V
C1101	1-126-935-11	ELECT	470μF 20% 16V	C1708	1-128-551-11	ELECT	22μF 20% 25V
C1102	1-164-004-11	CERAMIC CHIP	0.1μF 10% 25V	C1709	1-163-021-91	CERAMIC CHIP	0.01μF 10% 50V
C1103	1-164-004-11	CERAMIC CHIP	0.1μF 10% 25V	C1710	1-163-257-11	CERAMIC CHIP	180pF 5% 50V
C1104	1-164-004-11	CERAMIC CHIP	0.1μF 10% 25V	C1711	1-163-021-91	CERAMIC CHIP	0.01μF 10% 50V
C1105	1-128-551-11	ELECT	22μF 20% 25V	C1712	1-128-551-11	ELECT	22μF 20% 25V
C1106	1-128-551-11	ELECT	22μF 20% 25V	C1713	1-163-017-00	CERAMIC CHIP	0.0047μF 10% 50V
C1107	1-126-959-11	ELECT	0.47μF 20% 50V	C1714	1-163-021-91	CERAMIC CHIP	0.01μF 10% 50V
C1108	1-128-551-11	ELECT	22μF 20% 25V	C1715	1-163-021-91	CERAMIC CHIP	0.01μF 10% 50V
C1109	1-126-959-11	ELECT	0.47μF 20% 50V	C1716	1-163-021-91	CERAMIC CHIP	0.01μF 10% 50V
C1110	1-126-959-11	ELECT	0.47μF 20% 50V	C1717	1-163-021-91	CERAMIC CHIP	0.01μF 10% 50V
C1111	1-126-959-11	ELECT	0.47μF 20% 50V	C1718	1-163-021-91	CERAMIC CHIP	0.01μF 10% 50V
C1112	1-128-551-11	ELECT	22μF 20% 25V	C1719	1-163-231-11	CERAMIC CHIP	15pF 5% 50V
C1113	1-128-551-11	ELECT	22μF 20% 25V	C1720	1-163-021-91	CERAMIC CHIP	0.01μF 10% 50V
C1114	1-128-551-11	ELECT	22μF 20% 25V	C1721	1-163-021-91	CERAMIC CHIP	0.01μF 10% 50V
C1115	1-126-959-11	ELECT	0.47μF 20% 50V	C1722	1-128-551-11	ELECT	22μF 20% 25V
C1116	1-126-964-11	ELECT	10μF 20% 50V	C1723	1-163-021-91	CERAMIC CHIP	0.01μF 10% 50V
C1117	1-126-964-11	ELECT	10μF 20% 50V	C1724	1-163-021-91	CERAMIC CHIP	0.01μF 10% 50V
C1118	1-128-551-11	ELECT	22μF 20% 25V	C1725	1-163-021-91	CERAMIC CHIP	0.01μF 10% 50V
C1119	1-126-964-11	ELECT	10μF 20% 50V	C1726	1-128-551-11	ELECT	22μF 20% 25V
C1120	1-126-964-11	ELECT	10μF 20% 50V	C1727	1-163-021-91	CERAMIC CHIP	0.01μF 10% 50V
C1121	1-126-960-11	ELECT	1μF 20% 50V	C1728	1-128-551-11	ELECT	22μF 20% 25V
C1122	1-163-021-91	CERAMIC CHIP	0.01μF 10% 50V	C1729	1-163-021-91	CERAMIC CHIP	0.01μF 10% 50V
C1123	1-128-551-11	ELECT	22μF 20% 25V	C1730	1-126-959-11	ELECT	0.47μF 20% 50V
C1124	1-126-959-11	ELECT	0.47μF 20% 50V	C1731	1-163-231-11	CERAMIC CHIP	15pF 5% 50V
C1125	1-163-021-91	CERAMIC CHIP	0.01μF 10% 50V	C1732	1-163-231-11	CERAMIC CHIP	15pF 5% 50V
C1126	1-163-021-91	CERAMIC CHIP	0.01μF 10% 50V	C1733	1-163-021-91	CERAMIC CHIP	0.01μF 10% 50V
C1127	1-126-959-11	ELECT	0.47μF 20% 50V	C1735	1-163-127-00	CERAMIC CHIP	270pF 5% 50V
C1129	1-163-021-91	CERAMIC CHIP	0.01μF 10% 50V	C1901	1-164-004-11	CERAMIC CHIP	0.1μF 10% 25V
C1130	1-163-021-91	CERAMIC CHIP	0.01μF 10% 50V	C1902	1-164-004-11	CERAMIC CHIP	0.1μF 10% 25V
C1131	1-163-021-91	CERAMIC CHIP	0.01μF 10% 50V	C1903	1-164-004-11	CERAMIC CHIP	0.1μF 10% 25V
C1132	1-163-021-91	CERAMIC CHIP	0.01μF 10% 50V	C1904	1-163-021-91	CERAMIC CHIP	0.01μF 10% 50V
C1133	1-163-021-91	CERAMIC CHIP	0.01μF 10% 50V	C1905	1-128-551-11	ELECT	22μF 20% 25V
C1134	1-163-021-91	CERAMIC CHIP	0.01μF 10% 50V	C1906	1-164-489-11	CERAMIC CHIP	0.22μF 10% 16V
C1601	1-164-004-11	CERAMIC CHIP	0.1μF 10% 25V	C1907	1-163-251-11	CERAMIC CHIP	100pF 5% 50V
C1602	1-163-133-00	CERAMIC CHIP	470pF 5% 50V	C1908	1-163-021-91	CERAMIC CHIP	0.01μF 10% 50V
C1603	1-164-344-11	CERAMIC CHIP	0.068μF 10% 25V	C1909	1-164-489-11	CERAMIC CHIP	0.22μF 10% 16V
C1604	1-163-019-00	CERAMIC CHIP	0.0068μF 10% 50V	C1910	1-163-021-91	CERAMIC CHIP	0.01μF 10% 50V
C1605	1-164-004-11	CERAMIC CHIP	0.1μF 10% 25V	C1911	1-128-551-11	ELECT	22μF 20% 25V
C1606	1-117-720-11	CERAMIC CHIP	4.7μF 10V	C1912	1-164-004-11	CERAMIC CHIP	0.1μF 10% 25V
C1607	1-164-004-11	CERAMIC CHIP	0.1μF 10% 25V	C1913	1-164-346-11	CERAMIC CHIP	1μF 16V
C1608	1-163-239-11	CERAMIC CHIP	33pF 5% 50V	C1914	1-163-017-00	CERAMIC CHIP	0.0047μF 10% 50V
C1610	1-164-004-11	CERAMIC CHIP	0.1μF 10% 25V	C1915	1-164-346-11	CERAMIC CHIP	1μF 16V
C1613	1-164-344-11	CERAMIC CHIP	0.068μF 10% 25V	C1916	1-164-004-11	CERAMIC CHIP	0.1μF 10% 25V
C1614	1-163-019-00	CERAMIC CHIP	0.0068μF 10% 50V	C1917	1-164-004-11	CERAMIC CHIP	0.1μF 10% 25V
C1615	1-164-004-11	CERAMIC CHIP	0.1μF 10% 25V	C1918	1-164-005-11	CERAMIC CHIP	0.47μF 16V
C1617	1-163-133-00	CERAMIC CHIP	470pF 5% 50V	C1919	1-164-004-11	CERAMIC CHIP	0.1μF 10% 25V
C1618	1-164-004-11	CERAMIC CHIP	0.1μF 10% 25V	C1920	1-164-004-11	CERAMIC CHIP	0.1μF 10% 25V
C1619	1-163-038-91	CERAMIC CHIP	0.1μF 25V	C1921	1-126-963-11	ELECT	4.7μF 20% 50V
C1620	1-104-664-11	ELECT	47μF 20% 25V	C1922	1-164-004-11	CERAMIC CHIP	0.1μF 10% 25V



REF. NO.	PART NO.	DESCRIPTION	REMARK	REF. NO.	PART NO.	DESCRIPTION	REMARK
C1923	1-163-005-11	CERAMIC CHIP	470pF 10%	50V			
C1924	1-126-960-11	ELECT	1μF 20%	50V			
C1925	1-164-005-11	CERAMIC CHIP	0.47μF	16V			
C1926	1-128-551-11	ELECT	22μF 20%	25V			
C1927	1-163-021-91	CERAMIC CHIP	0.01μF	10%	50V		
C1928	1-163-021-91	CERAMIC CHIP	0.01μF	10%	50V		
C1929	1-163-021-91	CERAMIC CHIP	0.01μF	10%	50V		
C1930	1-163-229-11	CERAMIC CHIP	12pF	5%	50V		
C1931	1-163-021-91	CERAMIC CHIP	0.01μF	10%	50V		
C1932	1-128-551-11	ELECT	22μF 20%	25V			
C1933	1-164-004-11	CERAMIC CHIP	0.1μF	10%	25V		
C1934	1-164-004-11	CERAMIC CHIP	0.1μF	10%	25V		
C1935	1-164-004-11	CERAMIC CHIP	0.1μF	10%	25V		
C1936	1-163-021-91	CERAMIC CHIP	0.01μF	10%	50V		
C1937	1-128-551-11	ELECT	22μF 20%	25V			
C1938	1-163-021-91	CERAMIC CHIP	0.01μF	10%	50V		
C1939	1-163-021-91	CERAMIC CHIP	0.01μF	10%	50V		
C1940	1-128-551-11	ELECT	22μF 20%	25V			
C1941	1-128-551-11	ELECT	22μF 20%	25V			
C1942	1-128-551-11	ELECT	22μF 20%	25V			
C1943	1-163-021-91	CERAMIC CHIP	0.01μF	10%	50V		
C1944	1-163-021-91	CERAMIC CHIP	0.01μF	10%	50V		
C1945	1-163-021-91	CERAMIC CHIP	0.01μF	10%	50V		
C1946	1-163-239-11	CERAMIC CHIP	33pF	5%	50V		
C1947	1-163-239-11	CERAMIC CHIP	33pF	5%	50V		
C1948	1-163-021-91	CERAMIC CHIP	0.01μF	10%	50V		
C1949	1-126-960-11	ELECT	1μF 20%	50V			
C1950	1-163-021-91	CERAMIC CHIP	0.01μF	10%	50V		
C1951	1-163-021-91	CERAMIC CHIP	0.01μF	10%	50V		
C1952	1-128-551-11	ELECT	22μF 20%	25V			
C1953	1-163-021-91	CERAMIC CHIP	0.01μF	10%	50V		
C1954	1-163-021-91	CERAMIC CHIP	0.01μF	10%	50V		
C1955	1-163-259-91	CERAMIC CHIP	220pF	5%	50V		
C1958	1-163-251-11	CERAMIC CHIP	100pF	5%	50V		
C1959	1-163-251-11	CERAMIC CHIP	100pF	5%	50V		
C1960	1-163-021-91	CERAMIC CHIP	0.01μF	10%	50V		
C1961	1-128-551-11	ELECT	22μF 20%	25V			
C1962	1-163-021-91	CERAMIC CHIP	0.01μF	10%	50V		
C1963	1-126-960-11	ELECT	1μF 20%	50V			
C1964	1-164-004-11	CERAMIC CHIP	0.1μF	10%	25V		
C1965	1-164-004-11	CERAMIC CHIP	0.1μF	10%	25V		
C1966	1-164-004-11	CERAMIC CHIP	0.1μF	10%	25V		
C1967	1-128-551-11	ELECT	22μF 20%	25V			
C1969	1-163-021-91	CERAMIC CHIP	0.01μF	10%	50V		
C1970	1-163-021-91	CERAMIC CHIP	0.01μF	10%	50V		
C1971	1-163-021-91	CERAMIC CHIP	0.01μF	10%	50V		
C1972	1-163-021-91	CERAMIC CHIP	0.01μF	10%	50V		
		<JUMPER RESISTOR>					
CJ401	1-216-295-91	SHORT	0	(53N77)			
CJ402	1-216-295-91	SHORT	0	(53N77)			
CJ403	1-216-295-91	SHORT	0	(53N77)			
CJ404	1-216-295-91	SHORT	0	(53N77)			
		<CONNECTOR>					
CN001	* 1-564-507-11	PLUG, CONNECTOR	4P				
CN002	* 1-564-513-11	PLUG, CONNECTOR	10P				
CN003	1-573-979-21	CONNECTOR, BOARD TO BOARD	11P				
CN151	1-695-915-11	TAB (CONTACT)					
CN202	* 1-779-892-11	CONNECTOR, BOARD TO BOARD	10P				
CN203	* 1-564-509-11	PLUG, CONNECTOR	6P				
CN204	* 1-564-512-11	PLUG, CONNECTOR	9P				
CN205	1-695-915-11	TAB (CONTACT)					
CN402	* 1-779-892-11	CONNECTOR, BOARD TO BOARD	10P				
CN403	* 1-564-507-11	PLUG, CONNECTOR	4P				
CN681	* 1-779-892-11	CONNECTOR, BOARD TO BOARD	10P				
CN801	* 1-779-892-11	CONNECTOR, BOARD TO BOARD	10P				
CN802	* 1-564-511-11	PLUG, CONNECTOR	8P				
CN1702	1-764-334-11	PLUG, CONNECTOR	11P				
		<DIODE>					
D001	8-719-988-61	DIODE	1SS355TE-17				
D002	8-719-988-61	DIODE	1SS355TE-17				
D003	8-719-988-61	DIODE	1SS355TE-17				
D004	8-719-069-55	DIODE	UDZS-TE17-5.6B				
D005	8-719-988-61	DIODE	1SS355TE-17				
D006	8-719-069-55	DIODE	UDZS-TE17-5.6B				
D007	8-719-069-55	DIODE	UDZS-TE17-5.6B				
D151	8-719-977-81	DIODE	UDZ-TE-17-33B				
D202	8-719-977-28	DIODE	UDZS-TE17-10B				
D206	8-719-988-61	DIODE	1SS355TE-17				
D207	8-719-988-61	DIODE	1SS355TE-17				
D208	8-719-069-55	DIODE	UDZS-TE17-5.6B				
D209	8-719-988-61	DIODE	1SS355TE-17				
D301	8-719-988-61	DIODE	1SS355TE-17				
D302	8-719-988-61	DIODE	1SS355TE-17				
D303	8-719-988-61	DIODE	1SS355TE-17				
D304	8-719-069-59	DIODE	UDZS-TE17-8.2B				
D305	8-719-977-28	DIODE	UDZS-TE17-10B				
D402	8-719-988-61	DIODE	1SS355TE-17				
D403	8-719-988-61	DIODE	1SS355TE-17				
D404	8-719-988-61	DIODE	1SS355TE-17				
D405	8-719-988-61	DIODE	1SS355TE-17				
D406	8-719-056-95	DIODE	UDZ-TE-17-22B				
D407	8-719-988-61	DIODE	1SS355TE-17				
D408	8-719-988-61	DIODE	1SS355TE-17				
D409	8-719-920-67	DIODE	ERC91-02 (EXCEPT 53N77)				
D412	8-719-056-95	DIODE	UDZ-TE-17-22B				
D413	8-719-056-95	DIODE	UDZ-TE-17-22B				
D416	8-719-920-67	DIODE	ERC91-02 (EXCEPT 53N77)				
D418	8-719-056-95	DIODE	UDZ-TE-17-22B				
D420	8-719-988-61	DIODE	1SS355TE-17				
D421	8-719-988-61	DIODE	1SS355TE-17				
D801	8-719-988-61	DIODE	1SS355TE-17				
D802	8-719-988-61	DIODE	1SS355TE-17				
D803	8-719-988-61	DIODE	1SS355TE-17				
D804	8-719-988-61	DIODE	1SS355TE-17				
D805	8-719-069-55	DIODE	UDZS-TE17-5.6B				
D806	8-719-069-55	DIODE	UDZS-TE17-5.6B				



REF. NO.	PART NO.	DESCRIPTION	REMARK	REF. NO.	PART NO.	DESCRIPTION	REMARK
D807	8-719-069-55	DIODE UDZS-TE17-5.6B		FB216	1-216-295-91	SHORT	0
D808	8-719-069-55	DIODE UDZS-TE17-5.6B		FB217	1-216-295-91	SHORT	0
				FB301	1-216-295-91	SHORT	0
D809	8-719-988-61	DIODE 1SS355TE-17		FB801	1-414-135-11	FERRITE	0μH
D810	8-719-988-61	DIODE 1SS355TE-17		FB802	1-414-135-11	FERRITE	0μH
D816	8-719-988-61	DIODE 1SS355TE-17		FB803	1-414-135-11	FERRITE	0μH
D817	8-719-988-61	DIODE 1SS355TE-17		FB804	1-500-245-11	FERRITE	0μH
D818	8-719-988-61	DIODE 1SS355TE-17		FB805	1-500-245-11	FERRITE	0μH
D819	8-719-988-61	DIODE 1SS355TE-17					
D820	8-719-988-61	DIODE 1SS355TE-17		FB806	1-414-135-11	FERRITE	0μH
D821	8-719-988-61	DIODE 1SS355TE-17		FB807	1-414-135-11	FERRITE	0μH
D822	8-719-988-61	DIODE 1SS355TE-17		FB808	1-414-135-11	FERRITE	0μH
D823	8-719-988-61	DIODE 1SS355TE-17		FB1701	1-414-135-11	FERRITE	0μH
				FB1702	1-414-135-11	FERRITE	0μH
D824	8-719-988-61	DIODE 1SS355TE-17					
D1101	8-719-069-55	DIODE UDZS-TE17-5.6B		FB1902	1-414-135-11	FERRITE	0μH
D1102	8-719-977-28	DIODE UDZS-TE17-10B		FB2007	1-216-017-91	RES-CHIP	47 5% 1/10W
D1103	8-719-977-28	DIODE UDZS-TE17-10B					
D1104	8-719-977-28	DIODE UDZS-TE17-10B					
						<FILTER>	
D1105	8-719-977-28	DIODE UDZS-TE17-10B		FL1701	1-239-847-11	FILTER, LOW PASS	
D1106	8-719-977-28	DIODE UDZS-TE17-10B		FL1702	1-239-847-11	FILTER, LOW PASS	
D1107	8-719-977-28	DIODE UDZS-TE17-10B		FL1703	1-239-847-11	FILTER, LOW PASS	
D1108	8-719-977-28	DIODE UDZS-TE17-10B					
D1109	8-719-977-28	DIODE UDZS-TE17-10B					
						<IC>	
D1110	8-719-977-28	DIODE UDZS-TE17-10B		IC001	8-759-352-91	IC PST9143NL	
D1111	8-719-977-28	DIODE UDZS-TE17-10B		IC002	8-752-916-28	IC CXP750010-026Q	
D1112	8-719-977-28	DIODE UDZS-TE17-10B		IC004	8-759-527-76	IC M24C08-MN6T	
D1113	8-719-977-28	DIODE UDZS-TE17-10B		IC206	8-752-091-25	IC CXA2147Q	
D1114	8-719-977-28	DIODE UDZS-TE17-10B		IC301	8-759-353-02	IC NJM2533M(TE2)	
D1115	8-719-977-28	DIODE UDZS-TE17-10B					
D1116	8-719-977-28	DIODE UDZS-TE17-10B		IC403	8-759-578-88	IC BH3868FS-E2	
D1117	8-719-977-28	DIODE UDZS-TE17-10B		IC404	8-759-100-96	IC NJM4558M-T2	
D1118	8-719-977-28	DIODE UDZS-TE17-10B		IC406	8-759-190-89	IC TDA7265	
D1119	8-719-977-28	DIODE UDZS-TE17-10B		IC681	8-759-459-99	IC PQ09RD11	
				IC682	8-759-459-99	IC PQ09RD11	
D1120	8-719-988-61	DIODE 1SS355TE-17					
D1121	8-719-977-28	DIODE UDZS-TE17-10B		IC801	8-759-488-29	IC TC7W66FU(TE12R)	
D1122	8-719-977-28	DIODE UDZS-TE17-10B		IC802	8-759-394-80	IC NJM2058M-TE2	
D1123	8-719-988-61	DIODE 1SS355TE-17		IC803	8-759-589-66	IC CM0006CF	
D1124	8-719-988-61	DIODE 1SS355TE-17		IC804	8-759-394-80	IC NJM2058M-TE2	
				IC805	8-752-903-32	IC CXP86324-024Q	
D1125	8-719-988-61	DIODE 1SS355TE-17					
D1126	8-719-977-28	DIODE UDZS-TE17-10B		IC806	8-759-394-80	IC NJM2058M-TE2	
D1127	8-719-977-28	DIODE UDZS-TE17-10B		IC807	8-759-546-22	IC μPD6376GS-E2	
D1901	8-719-988-61	DIODE 1SS355TE-17		IC808	8-759-032-11	IC TC74HC04AF(EL)	
D1902	8-719-988-61	DIODE 1SS355TE-17		IC809	8-759-295-09	IC TLC2932IPW-E20	
				IC810	8-759-468-90	IC ST24E16FM6TR	
D1903	8-719-988-61	DIODE 1SS355TE-17					
D1904	8-719-988-61	DIODE 1SS355TE-17		IC811	8-759-352-91	IC PST9143NL	
D1905	8-719-988-61	DIODE 1SS355TE-17		IC812	8-759-235-19	IC TC74HC04AF(EL)	
D1906	8-719-988-61	DIODE 1SS355TE-17		IC814	8-759-032-20	IC TC74HC32AF(EL)	
				IC815	8-759-546-22	IC μPD6376GS-E2	
				IC816	8-759-546-22	IC μPD6376GS-E2	
		<FERRITE BEAD>					
FB001	1-414-135-11	FERRITE	0μH	IC817	8-759-546-22	IC μPD6376GS-E2	
FB151	1-414-135-11	FERRITE	0μH	IC818	8-759-100-96	IC NJM4558M-TE2	
FB152	1-414-135-11	FERRITE	0μH	IC819	8-759-106-02	IC μPC4570G2-E2	
FB206	1-216-017-91	RES-CHIP	47 5% 1/10W	IC820	8-759-106-02	IC μPC4570G2-E2	
FB209	1-216-017-91	RES-CHIP	47 5% 1/10W	IC821	8-759-106-02	IC μPC4570G2-E2	
FB212	1-216-295-91	SHORT	0	IC822	8-759-106-02	IC μPC4570G2-E2	
FB215	1-216-295-91	SHORT	0	IC823	8-759-106-02	IC μPC4570G2-E2	



REF. NO.	PART NO.	DESCRIPTION	REMARK	REF. NO.	PART NO.	DESCRIPTION	REMARK
IC824	8-759-106-02	IC μPC4570G2-E2				<IC LINK>	
IC1101	8-752-081-32	IC CXA2079Q					
IC1601	8-759-638-04	IC Z8622912SSC-00TR		PS401	1-532-984-11	LINK, IC 2A/90V	
				PS402	1-532-984-11	LINK, IC 2A/90V	
IC1602	8-759-638-05	IC Z8613012SSC-00TR				<TRANSISTOR>	
IC1603	8-759-352-91	IC PST9143NL					
IC1701	8-759-701-75	IC NJM7805FA					
IC1702	8-759-568-32	IC TC90A53F(ELP)					
IC1901	8-752-080-75	IC CXA2039M-T6		Q001	8-729-216-22	TRANSISTOR 2SB709A-QRS-TX	
				Q002	8-729-422-27	TRANSISTOR 2SD601A-QRS-TX	
IC1902	8-752-086-80	IC CXA2019AQ-T4		Q003	8-729-027-38	TRANSISTOR DTA144EKA-T146	
IC1903	8-759-932-69	IC BU4053BCF-T2		Q004	8-729-216-22	TRANSISTOR 2SB709A-QRS-TX	
IC1904	8-752-058-68	IC CXA1315M-T4		Q005	8-729-027-38	TRANSISTOR DTA144EKA-T146	
IC1905	8-759-655-57	IC SDA9288XE-B0121-GEG					
		<JACK>		Q006	8-729-027-38	TRANSISTOR DTA144EKA-T146	
J1101	1-774-751-11	TERMINAL BLOCK, S (VIDEO 3 IN)		Q007	1-801-806-11	TRANSISTOR DTC144EKA-T146	
J1102	1-774-751-11	TERMINAL BLOCK, S (VIDEO 1 IN)		Q008	8-729-422-27	TRANSISTOR 2SD601A-QRS-TX	
J1103	1-507-667-00	JACK, MIC (CONTROL S OUT)		Q009	8-729-422-27	TRANSISTOR 2SD601A-QRS-TX	
J1104	1-774-750-11	JACK BLOCK, PIN (AUDIO (VAR/FIX) OUT)		Q010	8-729-422-27	TRANSISTOR 2SD601A-QRS-TX	
J1105	1-774-749-11	JACK BLOCK, PIN (MONITOR OUT)					
J1106	1-785-082-11	JACK BLOCK, PIN 3P (Y/PB/PR)		Q011	8-729-422-27	TRANSISTOR 2SD601A-QRS-TX	
		<COIL>		Q012	8-729-422-27	TRANSISTOR 2SD601A-QRS-TX	
L001	1-414-183-41	INDUCTOR 10μH		Q013	8-729-422-27	TRANSISTOR 2SD601A-QRS-TX	
L004	1-410-397-21	FERRITE 1.1μH		Q014	8-729-422-27	TRANSISTOR 2SD601A-QRS-TX	
L151	1-414-187-11	INDUCTOR 47μH		Q015	8-729-422-27	TRANSISTOR 2SD601A-QRS-TX	
L152	1-414-187-11	INDUCTOR 47μH					
L153	1-414-187-11	INDUCTOR 47μH		Q016	8-729-422-27	TRANSISTOR 2SD601A-QRS-TX	
L154	1-414-183-41	INDUCTOR 10μH		Q017	8-729-422-27	TRANSISTOR 2SD601A-QRS-TX	
L155	1-414-187-11	INDUCTOR 47μH		Q018	8-729-422-27	TRANSISTOR 2SD601A-QRS-TX	
L211	1-414-857-11	INDUCTOR 100μH		Q019	8-729-422-27	TRANSISTOR 2SD601A-QRS-TX	
L212	1-414-856-11	INDUCTOR 10μH		Q020	8-729-422-27	TRANSISTOR 2SD601A-QRS-TX	
L681	1-406-975-21	INDUCTOR 47μH					
L801	1-414-183-41	INDUCTOR 10μH		Q021	8-729-422-27	TRANSISTOR 2SD601A-QRS-TX	
L802	1-414-183-41	INDUCTOR 10μH		Q022	8-729-422-27	TRANSISTOR 2SD601A-QRS-TX	
L803	1-414-183-41	INDUCTOR 10μH		Q023	8-729-422-27	TRANSISTOR 2SD601A-QRS-TX	
L804	1-414-183-41	INDUCTOR 10μH		Q024	1-801-806-11	TRANSISTOR DTC144EKA-T146	
L809	1-414-183-41	INDUCTOR 10μH		Q151	1-801-806-11	TRANSISTOR DTC144EKA-T146	
L816	1-414-183-41	INDUCTOR 10μH					
L823	1-410-494-11	INDUCTOR 1mH		Q152	8-729-422-27	TRANSISTOR 2SD601A-QRS-TX	
L824	1-410-494-11	INDUCTOR 1mH		Q153	8-729-422-27	TRANSISTOR 2SD601A-QRS-TX	
L825	1-410-494-11	INDUCTOR 1mH		Q205	8-729-216-22	TRANSISTOR 2SB709A-QRS-TX	
L826	1-410-494-11	INDUCTOR 1mH		Q217	8-729-422-27	TRANSISTOR 2SD601A-QRS-TX	
L827	1-410-494-11	INDUCTOR 1mH		Q218	8-729-216-22	TRANSISTOR 2SB709A-QRS-TX	
L828	1-410-494-11	INDUCTOR 1mH					
L829	1-414-183-41	INDUCTOR 10μH		Q219	8-729-216-22	TRANSISTOR 2SB709A-QRS-TX	
L830	1-407-495-00	INDUCTOR 1.8mH		Q220	8-729-216-22	TRANSISTOR 2SB709A-QRS-TX	
L831	1-407-495-00	INDUCTOR 1.8mH		Q221	8-729-216-22	TRANSISTOR 2SB709A-QRS-TX	
L832	1-407-495-00	INDUCTOR 1.8mH		Q222	8-729-422-27	TRANSISTOR 2SD601A-QRS-TX	
L833	1-407-495-00	INDUCTOR 1.8mH		Q223	8-729-422-27	TRANSISTOR 2SD601A-QRS-TX	
L834	1-407-495-00	INDUCTOR 1.8mH					
L835	1-407-495-00	INDUCTOR 1.8mH		Q224	8-729-422-27	TRANSISTOR 2SD601A-QRS-TX	
L843	1-414-183-41	INDUCTOR 10μH		Q225	8-729-422-27	TRANSISTOR 2SD601A-QRS-TX	
L1703	1-414-187-11	INDUCTOR 47μH		Q226	8-729-422-27	TRANSISTOR 2SD601A-QRS-TX	
				Q227	8-729-422-27	TRANSISTOR 2SD601A-QRS-TX	
				Q228	8-729-422-27	TRANSISTOR 2SD601A-QRS-TX	
				Q229	8-729-216-22	TRANSISTOR 2SB709A-QRS-TX	
				Q230	8-729-216-22	TRANSISTOR 2SB709A-QRS-TX	
				Q231	8-729-216-22	TRANSISTOR 2SB709A-QRS-TX	
				Q232	8-729-216-22	TRANSISTOR 2SB709A-QRS-TX	
				Q301	8-729-216-22	TRANSISTOR 2SB709A-QRS-TX	
				Q302	8-729-422-27	TRANSISTOR 2SD601A-QRS-TX	
				Q303	8-729-422-27	TRANSISTOR 2SD601A-QRS-TX	
				Q304	8-729-422-27	TRANSISTOR 2SD601A-QRS-TX	
				Q305	1-801-806-11	TRANSISTOR DTC144EKA-T146	
				Q306	8-729-422-27	TRANSISTOR 2SD601A-QRS-TX	



REF. NO.	PART NO.	DESCRIPTION	REMARK	REF. NO.	PART NO.	DESCRIPTION	REMARK
Q401	8-729-216-22	TRANSISTOR	2SB709A-QRS-TX	Q1901	8-729-216-22	TRANSISTOR	2SB709A-QRS-TX
Q402	8-729-216-22	TRANSISTOR	2SB709A-QRS-TX	Q1902	8-729-216-22	TRANSISTOR	2SB709A-QRS-TX
Q403	8-729-422-27	TRANSISTOR	2SD601A-QRS-TX	Q1903	8-729-216-22	TRANSISTOR	2SB709A-QRS-TX
Q404	8-729-422-27	TRANSISTOR	2SD601A-QRS-TX	Q1904	8-729-422-27	TRANSISTOR	2SD601A-QRS-TX
Q408	8-729-422-27	TRANSISTOR	2SD601A-QRS-TX				
Q409	8-729-422-27	TRANSISTOR	2SD601A-QRS-TX	Q1905	8-729-216-22	TRANSISTOR	2SB709A-QRS-TX
Q410	8-729-422-27	TRANSISTOR	2SD601A-QRS-TX	Q1906	8-729-422-27	TRANSISTOR	2SD601A-QRS-TX
Q411	8-729-216-22	TRANSISTOR	2SB709A-QRS-TX	Q1907	8-729-216-22	TRANSISTOR	2SB709A-QRS-TX
Q801	1-801-806-11	TRANSISTOR	DTC144EKA-T146	Q1908	8-729-216-22	TRANSISTOR	2SB709A-QRS-TX
Q802	1-801-806-11	TRANSISTOR	DTC144EKA-T146	Q1909	8-729-422-27	TRANSISTOR	2SD601A-QRS-TX
Q803	1-801-806-11	TRANSISTOR	DTC144EKA-T146	Q1910	8-729-216-22	TRANSISTOR	2SB709A-QRS-TX
Q804	1-801-806-11	TRANSISTOR	DTC144EKA-T146	Q1911	8-729-422-27	TRANSISTOR	2SD601A-QRS-TX
Q805	1-801-806-11	TRANSISTOR	DTC144EKA-T146	Q1913	8-729-422-27	TRANSISTOR	2SD601A-QRS-TX
Q806	8-729-422-27	TRANSISTOR	2SD601A-QRS-TX	Q1914	8-729-216-22	TRANSISTOR	2SB709A-QRS-TX
Q807	8-729-422-27	TRANSISTOR	2SD601A-QRS-TX	Q1915	8-729-422-27	TRANSISTOR	2SD601A-QRS-TX
Q808	8-729-422-27	TRANSISTOR	2SD601A-QRS-TX	Q1916	8-729-422-27	TRANSISTOR	2SD601A-QRS-TX
Q809	8-729-422-27	TRANSISTOR	2SD601A-QRS-TX	Q1917	8-729-422-27	TRANSISTOR	2SD601A-QRS-TX
Q811	8-729-422-27	TRANSISTOR	2SD601A-QRS-TX	Q1918	8-729-422-27	TRANSISTOR	2SD601A-QRS-TX
Q812	8-729-422-27	TRANSISTOR	2SD601A-QRS-TX	Q1920	8-729-422-27	TRANSISTOR	2SD601A-QRS-TX
Q813	8-729-422-27	TRANSISTOR	2SD601A-QRS-TX				
Q814	8-729-422-27	TRANSISTOR	2SD601A-QRS-TX			<RESISTOR>	
Q1101	8-729-027-56	TRANSISTOR	DTC143TKA-T146	R001	1-216-041-00	RES-CHIP	470 5% 1/10W
Q1102	8-729-422-27	TRANSISTOR	2SD601A-QRS-TX	R002	1-216-057-00	RES-CHIP	2.2K 5% 1/10W
Q1103	8-729-422-27	TRANSISTOR	2SD601A-QRS-TX	R003	1-216-049-91	RES-CHIP	1K 5% 1/10W
Q1104	8-729-422-27	TRANSISTOR	2SD601A-QRS-TX	R004	1-216-121-91	RES-CHIP	1M 5% 1/10W
Q1105	8-729-027-56	TRANSISTOR	DTC143TKA-T146	R005	1-216-097-91	RES-CHIP	100K 5% 1/10W
Q1106	8-729-422-27	TRANSISTOR	2SD601A-QRS-TX	R006	1-216-033-00	RES-CHIP	220 5% 1/10W
Q1107	8-729-422-27	TRANSISTOR	2SD601A-QRS-TX	R007	1-216-073-00	RES-CHIP	10K 5% 1/10W
Q1108	8-729-027-56	TRANSISTOR	DTC143TKA-T146	R008	1-216-033-00	RES-CHIP	220 5% 1/10W
Q1109	8-729-027-56	TRANSISTOR	DTC143TKA-T146	R009	1-216-033-00	RES-CHIP	220 5% 1/10W
Q1110	8-729-027-56	TRANSISTOR	DTC143TKA-T146	R010	1-216-073-00	RES-CHIP	10K 5% 1/10W
Q1111	8-729-216-22	TRANSISTOR	2SB709A-QRS-TX	R011	1-216-049-91	RES-CHIP	1K 5% 1/10W
Q1112	8-729-216-22	TRANSISTOR	2SB709A-QRS-TX	R013	1-216-073-00	RES-CHIP	10K 5% 1/10W
Q1113	8-729-422-27	TRANSISTOR	2SD601A-QRS-TX	R014	1-216-065-91	RES-CHIP	4.7K 5% 1/10W
Q1114	8-729-216-22	TRANSISTOR	2SB709A-QRS-TX	R015	1-216-065-91	RES-CHIP	4.7K 5% 1/10W
Q1115	8-729-216-22	TRANSISTOR	2SB709A-QRS-TX	R016	1-216-033-00	RES-CHIP	220 5% 1/10W
Q1116	8-729-422-27	TRANSISTOR	2SD601A-QRS-TX	R017	1-216-033-00	RES-CHIP	220 5% 1/10W
Q1117	8-729-422-27	TRANSISTOR	2SD601A-QRS-TX	R018	1-216-033-00	RES-CHIP	220 5% 1/10W
Q1118	8-729-422-27	TRANSISTOR	2SD601A-QRS-TX	R019	1-216-033-00	RES-CHIP	220 5% 1/10W
Q1119	8-729-422-27	TRANSISTOR	2SD601A-QRS-TX	R020	1-216-033-00	RES-CHIP	220 5% 1/10W
Q1121	1-801-806-11	TRANSISTOR	DTC144EKA-T146	R021	1-216-033-00	RES-CHIP	220 5% 1/10W
Q1122	8-729-422-27	TRANSISTOR	2SD601A-QRS-TX	R022	1-216-033-00	RES-CHIP	220 5% 1/10W
Q1124	8-729-216-22	TRANSISTOR	2SB709A-QRS-TX	R023	1-216-049-91	RES-CHIP	1K 5% 1/10W
Q1125	8-729-216-22	TRANSISTOR	2SB709A-QRS-TX	R024	1-216-025-91	RES-CHIP	100 5% 1/10W
Q1601	8-729-422-27	TRANSISTOR	2SD601A-QRS-TX	R025	1-216-025-91	RES-CHIP	100 5% 1/10W
Q1602	8-729-422-27	TRANSISTOR	2SD601A-QRS-TX	R026	1-216-025-91	RES-CHIP	100 5% 1/10W
Q1603	8-729-422-27	TRANSISTOR	2SD601A-QRS-TX	R027	1-216-025-91	RES-CHIP	100 5% 1/10W
Q1701	8-729-422-27	TRANSISTOR	2SD601A-QRS-TX	R028	1-216-065-91	RES-CHIP	4.7K 5% 1/10W
Q1702	8-729-422-27	TRANSISTOR	2SD601A-QRS-TX	R029	1-216-065-91	RES-CHIP	4.7K 5% 1/10W
Q1703	8-729-422-27	TRANSISTOR	2SD601A-QRS-TX	R030	1-216-033-00	RES-CHIP	220 5% 1/10W
Q1704	8-729-216-22	TRANSISTOR	2SB709A-QRS-TX	R031	1-216-037-00	RES-CHIP	330 5% 1/10W
Q1705	8-729-216-22	TRANSISTOR	2SB709A-QRS-TX	R032	1-216-033-00	RES-CHIP	220 5% 1/10W
Q1706	8-729-422-27	TRANSISTOR	2SD601A-QRS-TX	R033	1-216-033-00	RES-CHIP	220 5% 1/10W
Q1707	8-729-422-27	TRANSISTOR	2SD601A-QRS-TX	R034	1-216-033-00	RES-CHIP	220 5% 1/10W
Q1708	8-729-216-22	TRANSISTOR	2SB709A-QRS-TX	R035	1-216-033-00	RES-CHIP	220 5% 1/10W
Q1709	8-729-216-22	TRANSISTOR	2SB709A-QRS-TX	R037	1-216-057-00	RES-CHIP	2.2K 5% 1/10W



REF. NO.	PART NO.	DESCRIPTION		REMARK	REF. NO.	PART NO.	DESCRIPTION		REMARK
R040	1-216-057-00	RES-CHIP	2.2K	5%	1/10W	R105	1-216-017-91	RES-CHIP	47 5% 1/10W
R041	1-216-033-00	RES-CHIP	220	5%	1/10W	R106	1-216-017-91	RES-CHIP	47 5% 1/10W
R042	1-216-033-00	RES-CHIP	220	5%	1/10W	R107	1-216-017-91	RES-CHIP	47 5% 1/10W
R043	1-216-057-00	RES-CHIP	2.2K	5%	1/10W	R108	1-216-113-00	RES-CHIP	470K 5% 1/10W
R044	1-216-121-91	RES-CHIP	1M	5%	1/10W				
R045	1-216-097-91	RES-CHIP	100K	5%	1/10W	R109	1-216-113-00	RES-CHIP	470K 5% 1/10W
R046	1-216-073-00	RES-CHIP	10K	5%	1/10W	R110	1-216-043-91	RES-CHIP	560 5% 1/10W
R047	1-216-073-00	RES-CHIP	10K	5%	1/10W	R111	1-216-043-91	RES-CHIP	560 5% 1/10W
R048	1-216-065-91	RES-CHIP	4.7K	5%	1/10W	R112	1-216-043-91	RES-CHIP	560 5% 1/10W
R049	1-216-049-91	RES-CHIP	1K	5%	1/10W	R113	1-216-113-00	RES-CHIP	470K 5% 1/10W
R050	1-216-049-91	RES-CHIP	1K	5%	1/10W	R114	1-216-045-00	RES-CHIP	680 5% 1/10W
R051	1-216-049-91	RES-CHIP	1K	5%	1/10W	R115	1-216-045-00	RES-CHIP	680 5% 1/10W
R052	1-216-049-91	RES-CHIP	1K	5%	1/10W	R116	1-216-045-00	RES-CHIP	680 5% 1/10W
R053	1-216-049-91	RES-CHIP	1K	5%	1/10W	R117	1-216-295-91	SHORT	0
R054	1-216-033-00	RES-CHIP	220	5%	1/10W	R118	1-216-053-00	RES-CHIP	1.5K 5% 1/10W
R055	1-216-033-00	RES-CHIP	220	5%	1/10W	R119	1-216-053-00	RES-CHIP	1.5K 5% 1/10W
R056	1-216-049-91	RES-CHIP	1K	5%	1/10W	R120	1-216-061-00	RES-CHIP	3.3K 5% 1/10W
R057	1-216-049-91	RES-CHIP	1K	5%	1/10W	R121	1-216-057-00	RES-CHIP	2.2K 5% 1/10W
R058	1-216-089-91	RES-CHIP	47K	5%	1/10W	R122	1-216-295-91	SHORT	0
R059	1-216-089-91	RES-CHIP	47K	5%	1/10W	R123	1-216-017-91	RES-CHIP	47 5% 1/10W
R060	1-216-049-91	RES-CHIP	1K	5%	1/10W	R124	1-216-017-91	RES-CHIP	47 5% 1/10W
R061	1-216-041-00	RES-CHIP	470	5%	1/10W	R125	1-216-017-91	RES-CHIP	47 5% 1/10W
R062	1-216-065-91	RES-CHIP	4.7K	5%	1/10W	R127	1-216-025-91	RES-CHIP	100 5% 1/10W
R063	1-216-065-91	RES-CHIP	4.7K	5%	1/10W	R128	1-216-025-91	RES-CHIP	100 5% 1/10W
R064	1-216-065-91	RES-CHIP	4.7K	5%	1/10W	R129	1-216-073-00	RES-CHIP	10K 5% 1/10W
R066	1-216-065-91	RES-CHIP	4.7K	5%	1/10W	R130	1-216-057-00	RES-CHIP	2.2K 5% 1/10W
R068	1-216-065-91	RES-CHIP	4.7K	5%	1/10W	R131	1-216-073-00	RES-CHIP	10K 5% 1/10W
R070	1-216-033-00	RES-CHIP	220	5%	1/10W	R132	1-216-295-91	SHORT	0
R071	1-216-033-00	RES-CHIP	220	5%	1/10W	R135	1-216-295-91	SHORT	0
R072	1-216-065-91	RES-CHIP	4.7K	5%	1/10W	R151	1-216-025-91	RES-CHIP	100 5% 1/10W
R073	1-216-295-91	SHORT	0						
R074	1-216-065-91	RES-CHIP	4.7K	5%	1/10W	R152	1-216-083-00	RES-CHIP	27K 5% 1/10W
R075	1-216-061-00	RES-CHIP	3.3K	5%	1/10W	R153	1-216-689-11	RES-CHIP	39K 5% 1/10W
R077	1-216-053-00	RES-CHIP	1.5K	5%	1/10W	R154	1-216-043-91	RES-CHIP	560 5% 1/10W
R078	1-216-025-91	RES-CHIP	100	5%	1/10W	R155	1-216-025-91	RES-CHIP	100 5% 1/10W
R079	1-216-057-00	RES-CHIP	2.2K	5%	1/10W	R156	1-216-045-00	RES-CHIP	680 5% 1/10W
R084	1-216-025-91	RES-CHIP	100	5%	1/10W	R157	1-216-049-91	RES-CHIP	1K 5% 1/10W
R085	1-216-053-00	RES-CHIP	1.5K	5%	1/10W	R158	1-216-464-11	METAL OXIDE	18K 5% 2W
R086	1-216-053-00	RES-CHIP	1.5K	5%	1/10W	R159	1-216-041-00	RES-CHIP	470 5% 1/10W
R087	1-216-053-00	RES-CHIP	1.5K	5%	1/10W	R160	1-216-025-91	RES-CHIP	100 5% 1/10W
R088	1-216-025-91	RES-CHIP	100	5%	1/10W	R161	1-216-083-00	RES-CHIP	27K 5% 1/10W
R089	1-216-055-00	RES-CHIP	1.8K	5%	1/10W	R162	1-216-041-00	RES-CHIP	470 5% 1/10W
R090	1-216-113-00	RES-CHIP	470K	5%	1/10W	R163	1-216-689-11	RES-CHIP	39K 5% 1/10W
R091	1-216-017-91	RES-CHIP	47	5%	1/10W	R164	1-216-065-91	RES-CHIP	4.7K 5% 1/10W
R092	1-216-113-00	RES-CHIP	470K	5%	1/10W	R166	1-216-025-91	RES-CHIP	100 5% 1/10W
R093	1-216-017-91	RES-CHIP	47	5%	1/10W	R167	1-216-025-91	RES-CHIP	100 5% 1/10W
R094	1-216-113-00	RES-CHIP	470K	5%	1/10W	R168	1-216-025-91	RES-CHIP	100 5% 1/10W
R095	1-216-017-91	RES-CHIP	47	5%	1/10W	R169	1-208-789-11	METAL CHIP	2K 0.5% 1/10W
R096	1-216-055-00	RES-CHIP	1.8K	5%	1/10W	R170	1-216-025-91	RES-CHIP	100 5% 1/10W
R097	1-216-055-00	RES-CHIP	1.8K	5%	1/10W	R171	1-216-295-91	SHORT	0
R099	1-216-041-00	RES-CHIP	470	5%	1/10W	R203	1-216-051-00	RES-CHIP	1.2K 5% 1/10W
R100	1-216-041-00	RES-CHIP	470	5%	1/10W	R204	1-216-041-00	RES-CHIP	470 5% 1/10W
R101	1-216-041-00	RES-CHIP	470	5%	1/10W	R207	1-216-041-00	RES-CHIP	470 5% 1/10W
R102	1-216-113-00	RES-CHIP	470K	5%	1/10W	R208	1-216-295-91	SHORT	0
R103	1-216-113-00	RES-CHIP	470K	5%	1/10W	R274	1-216-073-00	RES-CHIP	10K 5% 1/10W
R104	1-216-113-00	RES-CHIP	470K	5%	1/10W	R275	1-216-057-00	RES-CHIP	2.2K 5% 1/10W
						R276	1-216-097-91	RES-CHIP	100K 5% 1/10W
						R277	1-216-089-91	RES-CHIP	47K 5% 1/10W



REF. NO.	PART NO.	DESCRIPTION	REMARK	REF. NO.	PART NO.	DESCRIPTION	REMARK
R278	1-216-073-00	RES-CHIP	10K 5% 1/10W	R334	1-216-113-00	RES-CHIP	470K 5% 1/10W
R279	1-216-129-00	RES-CHIP	2.2M 5% 1/10W	R335	1-216-041-00	RES-CHIP	470 5% 1/10W
R280	1-216-073-00	RES-CHIP	10K 5% 1/10W	R336	1-216-049-91	RES-CHIP	1K 5% 1/10W
R281	1-216-025-91	RES-CHIP	100 5% 1/10W	R337	1-216-049-91	RES-CHIP	1K 5% 1/10W
R282	1-216-065-91	RES-CHIP	4.7K 5% 1/10W	R338	1-216-077-91	RES-CHIP	15K 5% 1/10W
R283	1-216-065-91	RES-CHIP	4.7K 5% 1/10W	R339	1-216-049-91	RES-CHIP	1K 5% 1/10W
R284	1-216-025-91	RES-CHIP	100 5% 1/10W	R340	1-216-041-00	RES-CHIP	470 5% 1/10W
R285	1-216-049-91	RES-CHIP	1K 5% 1/10W	R341	1-216-041-00	RES-CHIP	470 5% 1/10W
R286	1-216-025-91	RES-CHIP	100 5% 1/10W	R342	1-216-049-91	RES-CHIP	1K 5% 1/10W
R287	1-216-025-91	RES-CHIP	100 5% 1/10W	R343	1-216-081-00	RES-CHIP	22K 5% 1/10W
R288	1-216-295-91	SHORT	0	R344	1-216-025-91	RES-CHIP	100 5% 1/10W
R289	1-216-049-91	RES-CHIP	1K 5% 1/10W	R345	1-216-049-91	RES-CHIP	1K 5% 1/10W
R290	1-216-049-91	RES-CHIP	1K 5% 1/10W	R346	1-216-089-91	RES-CHIP	47K 5% 1/10W
R291	1-216-049-91	RES-CHIP	1K 5% 1/10W	R347	1-216-073-00	RES-CHIP	10K 5% 1/10W
R292	1-216-049-91	RES-CHIP	1K 5% 1/10W	R348	1-216-079-00	RES-CHIP	18K 5% 1/10W
R293	1-216-049-91	RES-CHIP	1K 5% 1/10W	R349	1-216-077-91	RES-CHIP	15K 5% 1/10W
R294	1-216-049-91	RES-CHIP	1K 5% 1/10W	R350	1-216-073-00	RES-CHIP	10K 5% 1/10W
R295	1-216-295-91	SHORT	0	R351	1-216-041-00	RES-CHIP	470 5% 1/10W
R296	1-216-033-00	RES-CHIP	220 5% 1/10W	R352	1-216-081-00	RES-CHIP	22K 5% 1/10W
R297	1-216-033-00	RES-CHIP	220 5% 1/10W	R353	1-216-113-00	RES-CHIP	470K 5% 1/10W
R298	1-216-033-00	RES-CHIP	220 5% 1/10W	R354	1-216-065-91	RES-CHIP	4.7K 5% 1/10W
R299	1-216-033-00	RES-CHIP	220 5% 1/10W	R355	1-216-073-00	RES-CHIP	10K 5% 1/10W
R300	1-216-033-00	RES-CHIP	220 5% 1/10W	R356	1-216-063-91	RES-CHIP	3.9K 5% 1/10W
R301	1-216-033-00	RES-CHIP	220 5% 1/10W	R357	1-216-049-91	RES-CHIP	1K 5% 1/10W
R302	1-216-049-91	RES-CHIP	1K 5% 1/10W	R360	1-216-051-00	RES-CHIP	1.2K 5% 1/10W
R303	1-216-133-00	RES-CHIP	3.3M 5% 1/10W	R361	1-208-803-11	METAL CHIP	7.5K 0.5% 1/10W
R304	1-216-059-00	RES-CHIP	2.7K 5% 1/10W	R362	1-208-774-11	METAL CHIP	470 0.5% 1/10W
R305	1-216-066-00	RES-CHIP	5.1K 5% 1/10W	R363	1-208-798-11	METAL CHIP	4.7K 0.5% 1/10W
R306	1-208-774-11	METAL CHIP	470 0.5% 1/10W	R411	1-216-025-91	RES-CHIP	100 5% 1/10W
R307	1-208-810-11	METAL CHIP	15K 0.5% 1/10W	R412	1-216-025-91	RES-CHIP	100 5% 1/10W
R308	1-216-109-00	RES-CHIP	330K 5% 1/10W	R413	1-216-025-91	RES-CHIP	100 5% 1/10W
R309	1-216-061-00	RES-CHIP	3.3K 5% 1/10W	R414	1-216-081-00	RES-CHIP	22K 5% 1/10W
R310	1-216-033-00	RES-CHIP	220 5% 1/10W	R415	1-216-073-00	RES-CHIP	10K 5% 1/10W
R311	1-216-025-91	RES-CHIP	100 5% 1/10W	R418	1-216-025-91	RES-CHIP	100 5% 1/10W
R312	1-216-025-91	RES-CHIP	100 5% 1/10W	R419	1-216-025-91	RES-CHIP	100 5% 1/10W
R313	1-216-113-00	RES-CHIP	470K 5% 1/10W	R420	1-216-025-91	RES-CHIP	100 5% 1/10W
R314	1-216-025-91	RES-CHIP	100 5% 1/10W	R421	1-216-025-91	RES-CHIP	100 5% 1/10W
R315	1-216-043-91	RES-CHIP	560 5% 1/10W	R422	1-216-025-91	RES-CHIP	100 5% 1/10W
R316	1-216-049-91	RES-CHIP	1K 5% 1/10W	R423	1-216-089-91	RES-CHIP	47K 5% 1/10W
R317	1-216-059-00	RES-CHIP	2.7K 5% 1/10W	R425	1-216-025-91	RES-CHIP	100 5% 1/10W
R318	1-216-077-91	RES-CHIP	15K 5% 1/10W	R426	1-216-073-00	RES-CHIP	10K 5% 1/10W
R319	1-216-655-11	METAL CHIP	1.5K 0.5% 1/10W	R428	1-216-073-00	RES-CHIP	10K 5% 1/10W
R320	1-216-073-00	RES-CHIP	10K 5% 1/10W	R429	1-216-073-00	RES-CHIP	10K 5% 1/10W
R321	1-216-033-00	RES-CHIP	220 5% 1/10W	R430	1-216-041-00	RES-CHIP	470 5% 1/10W
R322	1-216-073-00	RES-CHIP	10K 5% 1/10W	R431	1-216-073-00	RES-CHIP	10K 5% 1/10W
R323	1-216-017-91	RES-CHIP	47 5% 1/10W	R432	1-216-041-00	RES-CHIP	470 5% 1/10W
R324	1-216-049-91	RES-CHIP	1K 5% 1/10W	R433	1-216-041-00	RES-CHIP	470 5% 1/10W
R325	1-216-073-00	RES-CHIP	10K 5% 1/10W	R434	1-216-097-91	RES-CHIP	100K 5% 1/10W
R326	1-216-073-00	RES-CHIP	10K 5% 1/10W	R435	1-216-073-00	RES-CHIP	10K 5% 1/10W
R327	1-216-073-00	RES-CHIP	10K 5% 1/10W	R436	1-216-079-00	RES-CHIP	18K 5% 1/10W
R328	1-216-049-91	RES-CHIP	1K 5% 1/10W	R437	1-216-046-00	RES-CHIP	750 5% 1/10W
R329	1-216-073-00	RES-CHIP	10K 5% 1/10W	R438	1-216-073-00	RES-CHIP	10K 5% 1/10W
R330	1-216-073-00	RES-CHIP	10K 5% 1/10W	R440	1-216-046-00	RES-CHIP	750 5% 1/10W
R331	1-216-065-91	RES-CHIP	4.7K 5% 1/10W	R441	1-216-049-91	RES-CHIP	1K 5% 1/10W
R332	1-216-073-00	RES-CHIP	10K 5% 1/10W	R442	1-216-041-00	RES-CHIP	470 5% 1/10W
R333	1-216-049-91	RES-CHIP	1K 5% 1/10W	R443	1-216-073-00	RES-CHIP	10K 5% 1/10W



REF. NO.	PART NO.	DESCRIPTION		REMARK	REF. NO.	PART NO.	DESCRIPTION		REMARK
R444	1-216-077-91	RES-CHIP	15K	5% 1/10W	R836	1-216-049-91	RES-CHIP	1K	5% 1/10W
R445	1-216-079-00	RES-CHIP	18K	5% 1/10W	R838	1-216-025-91	RES-CHIP	100	5% 1/10W
R446	1-216-085-00	RES-CHIP	33K	5% 1/10W	R839	1-216-025-91	RES-CHIP	100	5% 1/10W
R447	1-215-451-00	METAL	18K	1% 1/4W	R840	1-216-025-91	RES-CHIP	100	5% 1/10W
R447	1-215-453-00	METAL	22K	1% 1/4W (EXCEPT 53N77)	R842	1-216-025-91	RES-CHIP	100	5% 1/10W
R448	1-215-451-00	METAL	18K	1% 1/4W (EXCEPT 53N77)	R843	1-216-025-91	RES-CHIP	100	5% 1/10W
R448	1-215-453-00	METAL	22K	1% 1/4W (53N77)	R844	1-216-025-91	RES-CHIP	100	5% 1/10W
R449	1-216-049-91	RES-CHIP	1K	5% 1/10W	R846	1-216-025-91	RES-CHIP	100	5% 1/10W
R451	1-216-073-00	RES-CHIP	10K	5% 1/10W	R847	1-216-033-00	RES-CHIP	220	5% 1/10W
R452	1-216-083-00	RES-CHIP	27K	5% 1/10W	R848	1-216-025-91	RES-CHIP	100	5% 1/10W
R455	1-216-083-00	RES-CHIP	27K	5% 1/10W	R849	1-216-041-00	RES-CHIP	470	5% 1/10W
R458	1-249-389-11	CARBON	4.7	5% 1/4W	R850	1-216-041-00	RES-CHIP	470	5% 1/10W
R459	1-249-389-11	CARBON	4.7	5% 1/4W	R851	1-216-041-00	RES-CHIP	470	5% 1/10W
R460	1-216-089-91	RES-CHIP	47K	5% 1/10W	R852	1-208-814-91	METAL CHIP	22K	0.5% 1/10W
R461	1-216-025-91	RES-CHIP	100	5% 1/10W	R853	1-216-025-91	RES-CHIP	100	5% 1/10W
R462	1-216-075-00	RES-CHIP	12K	5% 1/10W	R854	1-216-025-91	RES-CHIP	100	5% 1/10W
R463	1-216-089-91	RES-CHIP	47K	5% 1/10W	R855	1-216-025-91	RES-CHIP	100	5% 1/10W
R464	1-216-089-91	RES-CHIP	47K	5% 1/10W	R856	1-216-033-00	RES-CHIP	220	5% 1/10W
R465	1-216-121-91	RES-CHIP	1M	5% 1/10W	R857	1-216-025-91	RES-CHIP	100	5% 1/10W
R466	1-216-079-00	RES-CHIP	18K	5% 1/10W	R858	1-216-073-00	RES-CHIP	10K	5% 1/10W
R467	1-216-077-91	RES-CHIP	15K	5% 1/10W	R859	1-216-081-00	RES-CHIP	22K	5% 1/10W
R468	1-216-295-91	SHORT	0		R860	1-216-025-91	RES-CHIP	100	5% 1/10W
R474	1-216-049-91	RES-CHIP	1K	5% 1/10W	R861	1-216-073-00	RES-CHIP	10K	5% 1/10W
R801	1-500-245-11	FERRITE	0μH		R862	1-216-073-00	RES-CHIP	10K	5% 1/10W
R802	1-500-245-11	FERRITE	0μH		R863	1-216-025-91	RES-CHIP	100	5% 1/10W
R803	1-500-245-11	FERRITE	0μH		R864	1-208-801-11	METAL CHIP	6.2K	0.5% 1/10W
R804	1-500-245-11	FERRITE	0μH		R865	1-216-025-91	RES-CHIP	100	5% 1/10W
R805	1-216-065-91	RES-CHIP	4.7K	5% 1/10W	R866	1-216-025-91	RES-CHIP	100	5% 1/10W
R806	1-216-113-00	RES-CHIP	470K	5% 1/10W	R867	1-216-025-91	RES-CHIP	100	5% 1/10W
R808	1-216-065-91	RES-CHIP	4.7K	5% 1/10W	R868	1-216-025-91	RES-CHIP	100	5% 1/10W
R810	1-216-295-91	SHORT	0		R869	1-216-025-91	RES-CHIP	100	5% 1/10W
R811	1-216-109-00	RES-CHIP	330K	5% 1/10W	R870	1-216-073-00	RES-CHIP	10K	5% 1/10W
R813	1-216-117-00	RES-CHIP	680K	5% 1/10W	R871	1-216-025-91	RES-CHIP	100	5% 1/10W
R814	1-216-117-00	RES-CHIP	680K	5% 1/10W	R872	1-216-025-91	RES-CHIP	100	5% 1/10W
R815	1-216-025-91	RES-CHIP	100	5% 1/10W	R873	1-216-025-91	RES-CHIP	100	5% 1/10W
R816	1-216-049-91	RES-CHIP	1K	5% 1/10W	R874	1-216-025-91	RES-CHIP	100	5% 1/10W
R817	1-216-025-91	RES-CHIP	100	5% 1/10W	R875	1-216-295-91	SHORT	0	
R818	1-216-025-91	RES-CHIP	100	5% 1/10W	R876	1-216-065-91	RES-CHIP	4.7K	5% 1/10W
R819	1-216-025-91	RES-CHIP	100	5% 1/10W	R877	1-208-816-11	METAL CHIP	27K	0.5% 1/10W
R820	1-216-295-91	SHORT	0		R878	1-216-049-91	RES-CHIP	1K	5% 1/10W
R821	1-216-295-91	SHORT	0		R879	1-216-295-91	SHORT	0	
R822	1-216-295-91	SHORT	0		R880	1-216-049-91	RES-CHIP	1K	5% 1/10W
R823	1-216-295-91	SHORT	0		R881	1-216-025-91	RES-CHIP	100	5% 1/10W
R824	1-216-025-91	RES-CHIP	100	5% 1/10W	R882	1-216-033-00	RES-CHIP	220	5% 1/10W
R825	1-216-025-91	RES-CHIP	100	5% 1/10W	R883	1-216-033-00	RES-CHIP	220	5% 1/10W
R828	1-216-049-91	RES-CHIP	1K	5% 1/10W	R884	1-216-049-91	RES-CHIP	1K	5% 1/10W
R829	1-216-073-00	RES-CHIP	10K	5% 1/10W	R885	1-216-025-91	RES-CHIP	100	5% 1/10W
R830	1-216-041-00	RES-CHIP	470	5% 1/10W	R887	1-414-551-11	FERRITE	0μH	
R831	1-216-049-91	RES-CHIP	1K	5% 1/10W	R888	1-216-025-91	RES-CHIP	100	5% 1/10W
R832	1-216-073-00	RES-CHIP	10K	5% 1/10W	R891	1-216-073-00	RES-CHIP	10K	5% 1/10W
R833	1-216-049-91	RES-CHIP	1K	5% 1/10W	R892	1-208-802-11	METAL CHIP	6.8K	0.5% 1/10W
R834	1-216-049-91	RES-CHIP	1K	5% 1/10W	R893	1-216-073-00	RES-CHIP	10K	5% 1/10W
					R894	1-216-033-00	RES-CHIP	220	5% 1/10W
					R895	1-216-025-91	RES-CHIP	100	5% 1/10W
					R896	1-216-121-91	RES-CHIP	1M	5% 1/10W
					R897	1-216-049-91	RES-CHIP	1K	5% 1/10W



REF. NO.	PART NO.	DESCRIPTION	REMARK	REF. NO.	PART NO.	DESCRIPTION	REMARK
R898	1-216-049-91	RES-CHIP	1K 5% 1/10W	R968	1-208-806-11	METAL CHIP	10K 0.5% 1/10W
R899	1-216-033-00	RES-CHIP	220 5% 1/10W	R970	1-208-806-11	METAL CHIP	10K 0.5% 1/10W
R900	1-216-025-91	RES-CHIP	100 5% 1/10W	R972	1-208-806-11	METAL CHIP	10K 0.5% 1/10W
R901	1-216-033-00	RES-CHIP	220 5% 1/10W	R974	1-208-806-11	METAL CHIP	10K 0.5% 1/10W
R902	1-216-033-00	RES-CHIP	220 5% 1/10W	R976	1-208-806-11	METAL CHIP	10K 0.5% 1/10W
R903	1-216-025-91	RES-CHIP	100 5% 1/10W	R978	1-208-810-11	METAL CHIP	15K 0.5% 1/10W
R904	1-216-033-00	RES-CHIP	220 5% 1/10W	R979	1-208-817-11	METAL CHIP	30K 0.5% 1/10W
R905	1-216-025-91	RES-CHIP	100 5% 1/10W	R980	1-208-817-11	METAL CHIP	30K 0.5% 1/10W
R906	1-216-025-91	RES-CHIP	100 5% 1/10W	R981	1-208-817-11	METAL CHIP	30K 0.5% 1/10W
R907	1-216-025-91	RES-CHIP	100 5% 1/10W	R982	1-208-817-11	METAL CHIP	30K 0.5% 1/10W
R908	1-216-025-91	RES-CHIP	100 5% 1/10W	R983	1-208-817-11	METAL CHIP	30K 0.5% 1/10W
R910	1-216-025-91	RES-CHIP	100 5% 1/10W	R985	1-208-810-11	METAL CHIP	15K 0.5% 1/10W
R911	1-216-025-91	RES-CHIP	100 5% 1/10W	R987	1-208-817-11	METAL CHIP	30K 0.5% 1/10W
R912	1-216-049-91	RES-CHIP	1K 5% 1/10W	R989	1-208-817-11	METAL CHIP	30K 0.5% 1/10W
R913	1-216-025-91	RES-CHIP	100 5% 1/10W	R991	1-208-817-11	METAL CHIP	30K 0.5% 1/10W
R914	1-216-049-91	RES-CHIP	1K 5% 1/10W	R993	1-208-817-11	METAL CHIP	30K 0.5% 1/10W
R915	1-216-049-91	RES-CHIP	1K 5% 1/10W	R994	1-208-817-11	METAL CHIP	30K 0.5% 1/10W
R916	1-216-049-91	RES-CHIP	1K 5% 1/10W	R996	1-208-776-11	METAL CHIP	560 0.5% 1/10W
R917	1-216-025-91	RES-CHIP	100 5% 1/10W	R997	1-208-776-11	METAL CHIP	560 0.5% 1/10W
R918	1-208-806-11	METAL CHIP	10K 0.5% 1/10W	R998	1-208-776-11	METAL CHIP	560 0.5% 1/10W
R919	1-216-061-00	RES-CHIP	3.3K 5% 1/10W	R999	1-208-776-11	METAL CHIP	560 0.5% 1/10W
R920	1-216-057-00	RES-CHIP	2.2K 5% 1/10W	R1000	1-208-776-11	METAL CHIP	560 0.5% 1/10W
R922	1-216-049-91	RES-CHIP	1K 5% 1/10W	R1001	1-208-776-11	METAL CHIP	560 0.5% 1/10W
R923	1-216-043-91	RES-CHIP	560 5% 1/10W	R1002	1-208-810-11	METAL CHIP	15K 0.5% 1/10W
R924	1-216-053-00	RES-CHIP	1.5K 5% 1/10W	R1003	1-208-818-11	METAL CHIP	33K 0.5% 1/10W
R925	1-216-043-91	RES-CHIP	560 5% 1/10W	R1010	1-216-295-91	SHORT	0
R926	1-216-053-00	RES-CHIP	1.5K 5% 1/10W	R1011	1-216-295-91	SHORT	0
R928	1-216-057-00	RES-CHIP	2.2K 5% 1/10W	R1012	1-216-295-91	SHORT	0
R929	1-216-049-91	RES-CHIP	1K 5% 1/10W	R1013	1-216-295-91	SHORT	0
R932	1-208-792-11	METAL CHIP	2.7K 0.5% 1/10W	R1014	1-216-295-91	SHORT	0
R935	1-216-025-91	RES-CHIP	100 5% 1/10W	R1015	1-216-295-91	SHORT	0
R936	1-216-025-91	RES-CHIP	100 5% 1/10W	R1101	1-216-041-00	RES-CHIP	470 5% 1/10W
R937	1-216-025-91	RES-CHIP	100 5% 1/10W	R1102	1-216-041-00	RES-CHIP	470 5% 1/10W
R938	1-208-766-11	METAL CHIP	220 0.5% 1/10W	R1103	1-216-022-00	RES-CHIP	75 5% 1/10W
R939	1-208-766-11	METAL CHIP	220 0.5% 1/10W	R1106	1-216-041-00	RES-CHIP	470 5% 1/10W
R941	1-216-061-00	RES-CHIP	3.3K 5% 1/10W	R1107	1-216-041-00	RES-CHIP	470 5% 1/10W
R942	1-216-065-91	RES-CHIP	4.7K 5% 1/10W	R1108	1-216-113-00	RES-CHIP	470K 5% 1/10W
R943	1-216-041-00	RES-CHIP	470 5% 1/10W	R1109	1-216-113-00	RES-CHIP	470K 5% 1/10W
R945	1-216-057-00	RES-CHIP	2.2K 5% 1/10W	R1110	1-216-089-91	RES-CHIP	47K 5% 1/10W
R950	1-216-043-91	RES-CHIP	560 5% 1/10W	R1111	1-216-025-91	RES-CHIP	100 5% 1/10W
R951	1-216-053-00	RES-CHIP	1.5K 5% 1/10W	R1112	1-216-022-00	RES-CHIP	75 5% 1/10W
R952	1-216-049-91	RES-CHIP	1K 5% 1/10W	R1113	1-216-022-00	RES-CHIP	75 5% 1/10W
R953	1-216-025-91	RES-CHIP	100 5% 1/10W	R1114	1-216-022-00	RES-CHIP	75 5% 1/10W
R954	1-216-025-91	RES-CHIP	100 5% 1/10W	R1115	1-216-113-00	RES-CHIP	470K 5% 1/10W
R955	1-216-025-91	RES-CHIP	100 5% 1/10W	R1116	1-216-113-00	RES-CHIP	470K 5% 1/10W
R956	1-216-025-91	RES-CHIP	100 5% 1/10W	R1117	1-216-022-00	RES-CHIP	75 5% 1/10W
R957	1-216-025-91	RES-CHIP	100 5% 1/10W	R1118	1-216-022-00	RES-CHIP	75 5% 1/10W
R958	1-216-025-91	RES-CHIP	100 5% 1/10W	R1119	1-216-022-00	RES-CHIP	75 5% 1/10W
R959	1-208-806-11	METAL CHIP	10K 0.5% 1/10W	R1120	1-216-113-00	RES-CHIP	470K 5% 1/10W
R960	1-208-806-11	METAL CHIP	10K 0.5% 1/10W	R1121	1-216-113-00	RES-CHIP	470K 5% 1/10W
R961	1-208-806-11	METAL CHIP	10K 0.5% 1/10W	R1122	1-216-022-00	RES-CHIP	75 5% 1/10W
R962	1-208-806-11	METAL CHIP	10K 0.5% 1/10W	R1123	1-216-022-00	RES-CHIP	75 5% 1/10W
R963	1-208-806-11	METAL CHIP	10K 0.5% 1/10W	R1124	1-216-022-00	RES-CHIP	75 5% 1/10W
R964	1-208-806-11	METAL CHIP	10K 0.5% 1/10W	R1126	1-216-113-00	RES-CHIP	470K 5% 1/10W
R965	1-208-806-11	METAL CHIP	10K 0.5% 1/10W	R1127	1-216-113-00	RES-CHIP	470K 5% 1/10W
R966	1-208-806-11	METAL CHIP	10K 0.5% 1/10W	R1128	1-216-019-00	RES-CHIP	56 5% 1/10W



REF. NO.	PART NO.	DESCRIPTION		REMARK	REF. NO.	PART NO.	DESCRIPTION		REMARK		
R1129	1-216-017-91	RES-CHIP	47	5%	1/10W	R1211	1-216-065-91	RES-CHIP	4.7K 5%	1/10W	
R1130	1-216-025-91	RES-CHIP	100	5%	1/10W	R1212	1-216-025-91	RES-CHIP	100	5%	1/10W
R1131	1-216-057-00	RES-CHIP	2.2K	5%	1/10W	R1213	1-216-025-91	RES-CHIP	100	5%	1/10W
R1132	1-216-073-00	RES-CHIP	10K	5%	1/10W	R1214	1-216-025-91	RES-CHIP	100	5%	1/10W
R1135	1-216-041-00	RES-CHIP	470	5%	1/10W	R1215	1-216-025-91	RES-CHIP	100	5%	1/10W
R1136	1-216-041-00	RES-CHIP	470	5%	1/10W	R1216	1-216-025-91	RES-CHIP	100	5%	1/10W
R1137	1-216-073-00	RES-CHIP	10K	5%	1/10W	R1217	1-216-025-91	RES-CHIP	100	5%	1/10W
R1138	1-216-089-91	RES-CHIP	47K	5%	1/10W	R1218	1-216-025-91	RES-CHIP	100	5%	1/10W
R1139	1-216-041-00	RES-CHIP	470	5%	1/10W	R1221	1-216-025-91	RES-CHIP	100	5%	1/10W
R1140	1-216-065-91	RES-CHIP	4.7K	5%	1/10W	R1222	1-216-295-91	SHORT	0		
R1141	1-216-073-00	RES-CHIP	10K	5%	1/10W	R1223	1-216-025-91	RES-CHIP	100	5%	1/10W
R1142	1-216-089-91	RES-CHIP	47K	5%	1/10W	R1601	1-216-065-91	RES-CHIP	4.7K	5%	1/10W
R1143	1-216-049-91	RES-CHIP	1K	5%	1/10W	R1603	1-216-049-91	RES-CHIP	1K	5%	1/10W
R1144	1-216-057-00	RES-CHIP	2.2K	5%	1/10W	R1604	1-216-049-91	RES-CHIP	1K	5%	1/10W
R1147	1-216-041-00	RES-CHIP	470	5%	1/10W	R1605	1-208-802-11	METAL CHIP	6.8K	0.5%	1/10W
R1148	1-216-041-00	RES-CHIP	470	5%	1/10W	R1607	1-208-806-11	METAL CHIP	10K	0.5%	1/10W
R1150	1-216-049-91	RES-CHIP	1K	5%	1/10W	R1609	1-216-025-91	RES-CHIP	100	5%	1/10W
R1151	1-216-105-91	RES-CHIP	220K	5%	1/10W	R1610	1-216-025-91	RES-CHIP	100	5%	1/10W
R1156	1-216-025-91	RES-CHIP	100	5%	1/10W	R1614	1-216-049-91	RES-CHIP	1K	5%	1/10W
R1157	1-216-065-91	RES-CHIP	4.7K	5%	1/10W	R1615	1-208-802-11	METAL CHIP	6.8K	0.5%	1/10W
R1158	1-216-025-91	RES-CHIP	100	5%	1/10W	R1616	1-216-049-91	RES-CHIP	1K	5%	1/10W
R1159	1-216-065-91	RES-CHIP	4.7K	5%	1/10W	R1617	1-216-081-00	RES-CHIP	22K	5%	1/10W
R1160	1-216-025-91	RES-CHIP	100	5%	1/10W	R1618	1-216-033-00	RES-CHIP	220	5%	1/10W
R1161	1-216-049-91	RES-CHIP	1K	5%	1/10W	R1619	1-216-057-00	RES-CHIP	2.2K	5%	1/10W
R1162	1-216-081-00	RES-CHIP	22K	5%	1/10W	R1621	1-208-806-11	METAL CHIP	10K	0.5%	1/10W
R1163	1-216-089-91	RES-CHIP	47K	5%	1/10W	R1622	1-216-033-00	RES-CHIP	220	5%	1/10W
R1164	1-216-093-91	RES-CHIP	68K	5%	1/10W	R1623	1-216-025-91	RES-CHIP	100	5%	1/10W
R1165	1-216-065-91	RES-CHIP	4.7K	5%	1/10W	R1624	1-216-025-91	RES-CHIP	100	5%	1/10W
R1166	1-216-097-91	RES-CHIP	100K	5%	1/10W	R1627	1-216-061-00	RES-CHIP	3.3K	5%	1/10W
R1167	1-216-065-91	RES-CHIP	4.7K	5%	1/10W	R1701	1-208-806-11	METAL CHIP	10K	0.5%	1/10W
R1168	1-216-081-00	RES-CHIP	22K	5%	1/10W	R1702	1-216-047-91	RES-CHIP	820	5%	1/10W
R1169	1-216-089-91	RES-CHIP	47K	5%	1/10W	R1703	1-208-806-11	METAL CHIP	10K	0.5%	1/10W
R1170	1-216-089-91	RES-CHIP	47K	5%	1/10W	R1704	1-216-114-00	RES-CHIP	510K	5%	1/10W
R1171	1-216-049-91	RES-CHIP	1K	5%	1/10W	R1706	1-216-469-11	METAL OXIDE	12	5%	3W
R1172	1-216-065-91	RES-CHIP	4.7K	5%	1/10W	R1707	1-216-049-91	RES-CHIP	1K	5%	1/10W
R1173	1-216-049-91	RES-CHIP	1K	5%	1/10W	R1708	1-208-776-11	METAL CHIP	560	0.5%	1/10W
R1174	1-208-774-11	METAL CHIP	470	0.5%	1/10W	R1711	1-216-295-91	SHORT	0		
R1175	1-208-774-11	METAL CHIP	470	0.5%	1/10W	R1712	1-208-800-11	METAL CHIP	5.6K	0.5%	1/10W
R1180	1-216-089-91	RES-CHIP	47K	5%	1/10W	R1714	1-208-808-11	METAL CHIP	12K	0.5%	1/10W
R1182	1-216-049-91	RES-CHIP	1K	5%	1/10W	R1715	1-216-295-91	SHORT	0		
R1183	1-208-774-11	METAL CHIP	470	0.5%	1/10W	R1717	1-216-295-91	SHORT	0		
R1184	1-208-766-11	METAL CHIP	220	0.5%	1/10W	R1720	1-208-804-11	METAL CHIP	8.2K	0.5%	1/10W
R1187	1-216-025-91	RES-CHIP	100	5%	1/10W	R1721	1-208-757-11	METAL CHIP	91	0.5%	1/10W
R1188	1-216-025-91	RES-CHIP	100	5%	1/10W	R1722	1-208-776-11	METAL CHIP	560	0.5%	1/10W
R1191	1-216-025-91	RES-CHIP	100	5%	1/10W	R1724	1-216-041-00	RES-CHIP	470	5%	1/10W
R1193	1-216-041-00	RES-CHIP	470	5%	1/10W	R1725	1-216-057-00	RES-CHIP	2.2K	5%	1/10W
R1197	1-216-041-00	RES-CHIP	470	5%	1/10W	R1726	1-216-057-00	RES-CHIP	2.2K	5%	1/10W
R1202	1-216-025-91	RES-CHIP	100	5%	1/10W	R1727	1-208-776-11	METAL CHIP	560	0.5%	1/10W
R1203	1-216-065-91	RES-CHIP	4.7K	5%	1/10W	R1728	1-208-776-11	METAL CHIP	560	0.5%	1/10W
R1204	1-216-025-91	RES-CHIP	100	5%	1/10W	R1729	1-208-800-11	METAL CHIP	5.6K	0.5%	1/10W
R1205	1-216-065-91	RES-CHIP	4.7K	5%	1/10W	R1730	1-208-800-11	METAL CHIP	5.6K	0.5%	1/10W
R1206	1-216-025-91	RES-CHIP	100	5%	1/10W	R1736	1-216-041-00	RES-CHIP	470	5%	1/10W
R1207	1-216-049-91	RES-CHIP	1K	5%	1/10W	R1738	1-208-774-11	METAL CHIP	470	0.5%	1/10W
R1208	1-216-025-91	RES-CHIP	100	5%	1/10W	R1739	1-216-049-91	RES-CHIP	1K	5%	1/10W
R1209	1-216-065-91	RES-CHIP	4.7K	5%	1/10W	R1741	1-216-041-00	RES-CHIP	470	5%	1/10W
R1210	1-216-025-91	RES-CHIP	100	5%	1/10W	R1742	1-216-049-91	RES-CHIP	1K	5%	1/10W



REF. NO.	PART NO.	DESCRIPTION	REMARK	REF. NO.	PART NO.	DESCRIPTION	REMARK
R1743	1-208-768-11	METAL CHIP	240 0.5% 1/10W	R1955	1-216-089-91	RES-CHIP	47K 5% 1/10W
R1745	1-208-772-11	METAL CHIP	390 0.5% 1/10W	R1956	1-208-806-11	METAL CHIP	10K 0.5% 1/10W
R1746	1-216-025-91	RES-CHIP	100 5% 1/10W	R1957	1-216-041-00	RES-CHIP	470 5% 1/10W
R1747	1-216-025-91	RES-CHIP	100 5% 1/10W	R1958	1-216-057-00	RES-CHIP	2.2K 5% 1/10W
R1901	1-216-049-91	RES-CHIP	1K 5% 1/10W	R1959	1-216-049-91	RES-CHIP	1K 5% 1/10W
R1902	1-216-049-91	RES-CHIP	1K 5% 1/10W	R1960	1-208-778-11	METAL CHIP	680 0.5% 1/10W
R1903	1-216-065-91	RES-CHIP	4.7K 5% 1/10W	R1961	1-208-778-11	METAL CHIP	680 0.5% 1/10W
R1904	1-216-065-91	RES-CHIP	4.7K 5% 1/10W	R1962	1-208-778-11	METAL CHIP	680 0.5% 1/10W
R1905	1-216-065-91	RES-CHIP	4.7K 5% 1/10W	R1963	1-216-069-00	RES-CHIP	6.8K 5% 1/10W
R1906	1-216-065-91	RES-CHIP	4.7K 5% 1/10W	R1964	1-216-049-91	RES-CHIP	1K 5% 1/10W
R1907	1-216-049-91	RES-CHIP	1K 5% 1/10W	R1965	1-216-025-91	RES-CHIP	100 5% 1/10W
R1908	1-216-049-91	RES-CHIP	1K 5% 1/10W	R1966	1-216-041-00	RES-CHIP	470 5% 1/10W
R1909	1-216-065-91	RES-CHIP	4.7K 5% 1/10W	R1967	1-216-049-91	RES-CHIP	1K 5% 1/10W
R1910	1-216-061-00	RES-CHIP	3.3K 5% 1/10W	R1968	1-216-049-91	RES-CHIP	1K 5% 1/10W
R1911	1-216-065-91	RES-CHIP	4.7K 5% 1/10W	R1969	1-208-774-11	METAL CHIP	470 0.5% 1/10W
R1912	1-216-065-91	RES-CHIP	4.7K 5% 1/10W	R1970	1-208-780-11	METAL CHIP	820 0.5% 1/10W
R1913	1-216-057-00	RES-CHIP	2.2K 5% 1/10W	R1972	1-216-057-00	RES-CHIP	2.2K 5% 1/10W
R1914	1-216-049-91	RES-CHIP	1K 5% 1/10W	R1974	1-216-097-91	RES-CHIP	100K 5% 1/10W
R1915	1-216-033-00	RES-CHIP	220 5% 1/10W	R1975	1-216-041-00	RES-CHIP	470 5% 1/10W
R1916	1-216-045-00	RES-CHIP	680 5% 1/10W	R1976	1-208-776-11	METAL CHIP	560 0.5% 1/10W
R1917	1-216-061-00	RES-CHIP	3.3K 5% 1/10W	R1977	1-216-075-00	RES-CHIP	12K 5% 1/10W
R1918	1-216-025-91	RES-CHIP	100 5% 1/10W	R1978	1-216-081-00	RES-CHIP	22K 5% 1/10W
R1919	1-216-025-91	RES-CHIP	100 5% 1/10W	R1979	1-216-033-00	RES-CHIP	220 5% 1/10W
R1920	1-216-073-00	RES-CHIP	10K 5% 1/10W	R1980	1-216-033-00	RES-CHIP	220 5% 1/10W
R1921	1-216-109-00	RES-CHIP	330K 5% 1/10W	R1981	1-216-057-00	RES-CHIP	2.2K 5% 1/10W
R1923	1-216-049-91	RES-CHIP	1K 5% 1/10W	R1982	1-216-097-91	RES-CHIP	100K 5% 1/10W
R1924	1-216-049-91	RES-CHIP	1K 5% 1/10W	R1983	1-208-794-11	METAL CHIP	3.3K 0.5% 1/10W
R1925	1-216-049-91	RES-CHIP	1K 5% 1/10W			<TUNER>	
R1926	1-208-774-11	METAL CHIP	470 0.5% 1/10W	TU151	8-598-431-00	TUNER, FSS BTF-WA411	
R1927	1-216-025-91	RES-CHIP	100 5% 1/10W	TU152	8-598-430-00	TUNER, FSS BTF-FA401	
R1928	1-216-025-91	RES-CHIP	100 5% 1/10W			<CRYSTAL>	
R1929	1-208-801-11	METAL CHIP	6.2K 0.5% 1/10W	X001	1-781-589-21	VIBRATOR, CRYSTAL 16MHz	
R1930	1-216-295-91	SHORT	0	X202	1-567-505-11	OSCILLATOR, CRYSTAL 3.58MHz	
R1931	1-216-071-00	RES-CHIP	8.2K 5% 1/10W	X203	1-579-583-11	VIBRATOR, CERAMIC 503.5kHz	
R1932	1-216-077-91	RES-CHIP	15K 5% 1/10W	X801	1-767-925-21	VIBRATOR, CRYSTAL 12MHz	
R1933	1-216-025-91	RES-CHIP	100 5% 1/10W	X1901	1-579-583-11	VIBRATOR, CERAMIC 503.5kHz	
R1934	1-216-049-91	RES-CHIP	1K 5% 1/10W	X1902	1-567-505-11	OSCILLATOR, CRYSTAL 3.58MHz	
R1935	1-216-073-00	RES-CHIP	10K 5% 1/10W	X1903	1-760-095-21	VIBRATOR, CRYSTAL 20.48MHz	
R1936	1-216-053-00	RES-CHIP	1.5K 5% 1/10W			*****	
R1937	1-216-073-00	RES-CHIP	10K 5% 1/10W				
R1938	1-216-025-91	RES-CHIP	100 5% 1/10W				
R1939	1-216-025-91	RES-CHIP	100 5% 1/10W				
R1940	1-216-025-91	RES-CHIP	100 5% 1/10W				
R1941	1-216-073-00	RES-CHIP	10K 5% 1/10W				
R1942	1-216-025-91	RES-CHIP	100 5% 1/10W				
R1943	1-216-053-00	RES-CHIP	1.5K 5% 1/10W				
R1944	1-216-073-00	RES-CHIP	10K 5% 1/10W				
R1945	1-216-025-91	RES-CHIP	100 5% 1/10W				
R1947	1-216-295-91	SHORT	0				
R1948	1-216-025-91	RES-CHIP	100 5% 1/10W				
R1949	1-216-025-91	RES-CHIP	100 5% 1/10W				
R1950	1-216-025-91	RES-CHIP	100 5% 1/10W				
R1951	1-216-089-91	RES-CHIP	47K 5% 1/10W				
R1952	1-216-049-91	RES-CHIP	1K 5% 1/10W				
R1953	1-216-025-91	RES-CHIP	100 5% 1/10W				
R1954	1-216-025-91	RES-CHIP	100 5% 1/10W				

Les composants identifiés par une trame et une marque Δ sont critiques pour la sécurité. Ne les remplacer que par une pièce portant le numéro spécifié.

The components identified by shading and mark Δ are critical for safety. Replace only with part number specified.

• The components identified by \blacktriangle in this manual have been carefully factory-selected for each set in order to satisfy regulations regarding X-ray radiation. Should replacement be required, replace only with the value originally used.



REF. NO.	PART NO.	DESCRIPTION	REMARK	REF. NO.	PART NO.	DESCRIPTION	REMARK
* A-1316-437-A	G BOARD, COMPLETE (53S75/53N77)			C555	1-104-665-11	ELECT	100 μ F 20% 25V
*****				C556	1-104-665-11	ELECT	100 μ F 20% 25V
* A-1316-471-A	G BOARD, COMPLETE (48S75/61S75)			C557	1-128-562-11	ELECT	47 μ F 20% 100V
*****				C563	1-104-664-11	ELECT	47 μ F 20% 25V
* A-1316-475-A	G BOARD, COMPLETE (43T75)			C564	1-102-129-00	CERAMIC	0.01 μ F 10% 50V
*****				C565	1-102-129-00	CERAMIC	0.01 μ F 10% 50V
* A-1316-498-A	G BOARD, COMPLETE (61S75 Serial No. 9,500,001-)			C566	1-104-666-11	ELECT	220 μ F 20% 25V
*****				C567	1-106-387-00	MYLAR	0.068 μ F 5% 200V
* A-1316-499-A	G BOARD, COMPLETE (53S75 Serial No. 9,500,001-)			C601 Δ	1-136-311-11	MYLAR	0.47 μ F 20% 125V
*****				C602	1-129-722-00	FILM	0.047 μ F 5% 630V
1-533-223-11	HOLDER, FUSE			C604 Δ	1-113-920-11	CERAMIC	0.0022 μ F 20% 250V
* 4-039-590-01	SHIELD, TRANSFORMER			C606 Δ	1-113-920-11	CERAMIC	0.0022 μ F 20% 250V
4-382-854-11	SCREW (M3X10), P, SW (+)			C607 Δ	1-136-311-11	MYLAR	0.47 μ F 20% 125V
7-682-952-09	SCREW +PSW 3X16			C608	1-107-670-11	ELECT	10 μ F 20% 400V
<CAPACITOR>				C609	1-130-467-00	MYLAR	470pF 5% 50V
C501	1-126-959-11	ELECT	0.47 μ F 20% 50V	C610	1-130-471-00	MYLAR	0.001 μ F 5% 50V
C502	1-102-002-00	CERAMIC	680pF 10% 500V	C611	1-104-350-11	ELECT(BLOCK)	1000 μ F 20% 250V
C505	1-106-383-00	MYLAR	0.047 μ F 10% 200V	C612	1-104-350-11	ELECT(BLOCK)	1000 μ F 20% 250V
C506	1-102-212-00	CERAMIC	820pF 10% 500V	C613	1-136-165-00	MYLAR	0.1 μ F 5% 50V
C508	1-102-002-00	CERAMIC	680pF 10% 500V	C614	1-130-467-00	MYLAR	470pF 5% 50V
C510	1-130-471-00	MYLAR	0.001 μ F 5% 50V	C615	1-104-331-11	CERAMIC	0.0022 μ F 10% 1KV
C513	1-126-933-11	ELECT	100 μ F 20% 16V	C616	1-130-471-00	MYLAR	0.001 μ F 5% 50V
C514	1-130-495-00	MYLAR	0.1 μ F 5% 50V	C617	1-137-605-11	MYLAR	0.01 μ F 10% 250V
C515	1-126-960-11	ELECT	1 μ F 20% 50V	C618	1-126-965-11	ELECT	22 μ F 20% 50V
C516	1-126-965-11	ELECT	22 μ F 20% 50V	C619	1-104-664-11	ELECT	47 μ F 20% 16V
\blacktriangle C517 Δ	CERAMIC		2KV	C620	1-136-175-00	MYLAR	0.68 μ F 5% 50V
C518	1-130-487-00	MYLAR	0.022 μ F 5% 50V	C622	1-136-171-00	MYLAR	0.33 μ F 5% 50V
C521 Δ	1-128-660-91	FILM	0.039 μ F 3% 630V	C623	1-136-171-00	MYLAR	0.33 μ F 5% 50V
C522 Δ	1-117-658-11	FILM	14000pF 3% 1.2KV	C624	1-104-330-91	CERAMIC	470pF 10% 1KV
C525	1-136-479-11	FILM	0.001 μ F 5% 50V	C625	1-104-664-11	ELECT	47 μ F 20% 16V
C526	1-130-475-00	MYLAR	0.0022 μ F 5% 50V	C626	1-104-664-11	ELECT	47 μ F 20% 16V
C527	1-129-702-00	FILM	0.001 μ F 5% 630V	C651	1-164-644-11	CERAMIC	330pF 10% 500V
C529	1-130-495-00	MYLAR	0.1 μ F 5% 50V	C654	1-126-953-11	ELECT	2200 μ F 20% 35V
C531	1-117-673-11	FILM	1.5 μ F 5% 250V	C655	1-126-953-11	ELECT	2200 μ F 20% 35V
C533	1-106-359-00	MYLAR	0.0047 μ F 5% 100V	C656	1-102-121-00	CERAMIC	0.0022 μ F 10% 50V
C534	1-162-116-00	CERAMIC	680pF 10% 2KV	C657	1-126-768-11	ELECT	2200 μ F 20% 16V
C535	1-162-116-00	CERAMIC	680pF 10% 2KV	C658	1-126-943-11	ELECT	2200 μ F 20% 25V
C536	1-126-965-11	ELECT	22 μ F 20% 50V	C659	1-126-943-11	ELECT	2200 μ F 20% 25V
C537	1-102-244-00	CERAMIC	220pF 10% 500V	C662	1-123-024-21	ELECT	33 μ F 160V
C538	1-106-359-00	MYLAR	0.0047 μ F 5% 100V	C663	1-104-665-11	ELECT	100 μ F 20% 25V
C540	1-107-645-11	ELECT	22 μ F 20% 160V	C664	1-107-910-11	ELECT	100 μ F 20% 35V
C542	1-102-228-00	CERAMIC	470pF 10% 500V	C665	1-126-934-11	ELECT	220 μ F 20% 10V
C543	1-117-813-11	FILM	0.75 μ F 5% 250V	C666	1-126-927-11	ELECT	2200 μ F 20% 10V
C544	1-110-626-11	ELECT	330 μ F 20% 160V	C667	1-104-664-11	ELECT	47 μ F 20% 25V
C545	1-162-114-00	CERAMIC	0.0047 μ F 2KV	C668	1-104-664-11	ELECT	47 μ F 20% 25V
C546	1-107-649-11	ELECT	2.2 μ F 20% 250V	C669	1-104-664-11	ELECT	47 μ F 20% 25V
C547	1-126-971-11	ELECT	470 μ F 20% 50V	C670	1-106-343-00	MYLAR	0.001 μ F 10% 200V
C548	1-104-665-11	ELECT	100 μ F 20% 25V	C671	1-106-343-00	MYLAR	0.001 μ F 10% 200V
C549	1-130-489-00	MYLAR	0.033 μ F 5% 50V	C672	1-104-664-11	ELECT	47 μ F 20% 25V
C550	1-104-665-11	ELECT	100 μ F 20% 25V	C673	1-126-960-11	ELECT	1 μ F 20% 50V
C551	1-126-971-11	ELECT	470 μ F 20% 50V	C674	1-104-664-11	ELECT	47 μ F 20% 25V
C552	1-130-489-00	MYLAR	0.033 μ F 5% 50V	C676	1-126-940-11	ELECT	330 μ F 20% 25V
C553	1-126-935-11	ELECT	470 μ F 20% 16V	C678	1-104-665-11	ELECT	100 μ F 20% 25V
C554	1-126-935-11	ELECT	470 μ F 20% 16V	C679	1-104-664-11	ELECT	47 μ F 20% 25V
				C680	1-128-551-11	ELECT	22 μ F 20% 25V



Les composants identifiés par une trame et une marque Δ sont critiques pour la sécurité. Ne les remplacer que par une pièce portant le numéro spécifique.

The components identified by shading and mark Δ are critical for safety. Replace only with part number specified.

REF. NO.	PART NO.	DESCRIPTION	REMARK
C1501	1-130-495-00	MYLAR	0.1μF 5% 50V
C1502	1-126-941-11	ELECT	470μF 20% 25V
C1504	1-102-106-00	CERAMIC	100pF 10% 50V
C1505	1-104-664-11	ELECT	47μF 20% 25V
C1506	1-102-106-00	CERAMIC	100pF 10% 50V
C1507	1-126-942-61	ELECT	1000μF 20% 25V
C1508	1-102-121-00	CERAMIC	0.0022μF 10% 50V
C1510	1-126-941-11	ELECT	470μF 20% 25V
C1511	1-126-964-11	ELECT	10μF 20% 50V
C1512	1-126-933-11	ELECT	100μF 20% 16V
C1513	1-126-964-11	ELECT	10μF 20% 50V
C1516	1-104-665-11	ELECT	100μF 20% 25V
C1517	1-130-471-00	MYLAR	0.001μF 5% 50V
C1518	1-102-125-00	CERAMIC	0.0047μF 10% 50V
C1519	1-102-106-00	CERAMIC	100pF 10% 50V
C1520	1-126-933-11	ELECT	100μF 20% 16V
C1521	1-126-941-11	ELECT	470μF 20% 25V
C1522	1-126-941-11	ELECT	470μF 20% 25V
C1523	1-126-964-11	ELECT	10μF 20% 50V
C1524	1-102-106-00	CERAMIC	100pF 10% 50V
C1525	1-102-852-91	CERAMIC	47pF 5% 50V
C1526	1-136-177-00	MYLAR	1μF 5% 50V
C1527	1-102-125-00	CERAMIC	0.0047μF 10% 50V
C1528	1-126-941-11	ELECT	470μF 20% 25V
C1530	1-102-106-00	CERAMIC	100pF 10% 50V
C1531	1-102-106-00	CERAMIC	100pF 10% 50V
C1533	1-126-941-11	ELECT	470μF 20% 25V
C1534	1-102-125-00	CERAMIC	0.0047μF 10% 50V
C1536	1-102-106-00	CERAMIC	100pF 10% 50V
C1537	1-102-125-00	CERAMIC	0.0047μF 10% 50V
C1538	1-126-941-11	ELECT	470μF 20% 25V
C1539	1-104-665-11	ELECT	100μF 20% 25V
C1540	1-126-941-11	ELECT	470μF 20% 25V
C1541	1-102-125-00	CERAMIC	0.0047μF 10% 50V
C1542	1-102-125-00	CERAMIC	0.0047μF 10% 50V
C1543	1-102-129-00	CERAMIC	0.01μF 10% 50V
C1544	1-102-129-00	CERAMIC	0.01μF 10% 50V
C1545	1-126-933-11	ELECT	100μF 20% 16V
C1546	1-102-125-00	CERAMIC	0.0047μF 10% 50V
C1547	1-130-487-00	MYLAR	0.022μF 5% 50V
C1548	1-136-177-00	MYLAR	1μF 5% 50V
C1549	1-130-471-00	MYLAR	0.001μF 5% 50V
C1550	1-104-665-11	ELECT	100μF 20% 25V
C1551	1-102-121-00	CERAMIC	0.0022μF 10% 50V
C1552	1-106-220-00	MYLAR	0.1μF 5% 100V
C1555	1-104-665-11	ELECT	100μF 20% 25V
C1556	1-104-665-11	ELECT	100μF 20% 25V
C1557	1-126-969-11	ELECT	220μF 20% 50V
C1559	1-137-401-11	MYLAR	0.22μF 5% 100V
C1560	1-126-942-61	ELECT	1000μF 20% 25V
C1561	1-102-121-00	CERAMIC	0.0022μF 10% 50V
C1562	1-102-125-00	CERAMIC	0.0047μF 10% 50V
C1563	1-137-370-11	MYLAR	0.01μF 5% 50V
C1566	1-137-370-11	MYLAR	0.01μF 5% 50V
C1570	1-130-471-00	MYLAR	0.001μF 5% 50V
C1571	1-102-074-00	CERAMIC	0.001μF 10% 50V
C1572	1-102-074-00	CERAMIC	0.001μF 10% 50V

REF. NO.	PART NO.	DESCRIPTION	REMARK
<CONNECTOR>			
CN501	* 1-779-890-11	CONNECTOR, BOARD TO BOARD 10P	
CN502	* 1-506-371-00	PIN, CONNECTOR 2P	
CN503	* 1-564-513-11	PLUG, CONNECTOR 10P	
CN504	* 1-580-689-11	PIN, CONNECTOR (PC BOARD) 4P	
CN505	* 1-580-689-11	PIN, CONNECTOR (PC BOARD) 4P	
CN506	* 1-580-689-11	PIN, CONNECTOR (PC BOARD) 4P	
CN507	* 1-691-134-11	PIN, CONNECTOR (PC BOARD) 2P	
CN508	1-695-915-11	TAB (CONTACT)	
(53S75/61S75 Serial No. 9,500,001-)			
CN601	* 1-580-843-11	PIN, CONNECTOR (POWER)	
CN605	* 1-779-890-11	CONNECTOR, BOARD TO BOARD 10P	
CN651	* 1-779-890-11	CONNECTOR, BOARD TO BOARD 10P	
CN652	* 1-573-963-11	PIN, CONNECTOR (PC BOARD) 3P	
CN653	1-695-915-11	TAB (CONTACT)	
CN1501	* 1-564-507-11	PLUG, CONNECTOR 4P	
CN1502	* 1-779-890-11	CONNECTOR, BOARD TO BOARD 10P	
CN1503	* 1-564-507-11	PLUG, CONNECTOR 4P	
CN1504	* 1-564-507-11	PLUG, CONNECTOR 4P	
CN1505	* 1-564-507-11	PLUG, CONNECTOR 4P	
CN1506	* 1-564-506-11	PLUG, CONNECTOR 3P	
CN1507	* 1-564-506-11	PLUG, CONNECTOR 3P	
CN1508	* 1-564-506-11	PLUG, CONNECTOR 3P	
<DIODE>			
D501	8-719-109-85	DIODE MTZJ-T-77-5.1B	
D505	8-719-110-41	DIODE MTZJ-T-77-15B	
D506	8-719-921-63	DIODE MTZJ-T-77-7.5B	
D507	8-719-991-33	DIODE 1SS133T-77	
D513	8-719-991-33	DIODE 1SS133T-77	
D517	8-719-979-85	DIODE RGP15J-6040G23	
D518	8-719-945-80	DIODE ERC06-15S	
D520	8-719-302-43	DIODE RGP10GPKG23	
D522	Δ 8-719-302-43	DIODE ELI Z-V1	
D525	8-719-018-82	DIODE RGP02-20EL-6394	
D526	8-719-018-82	DIODE RGP02-20EL-6394	
D528	8-719-908-03	DIODE GP08DPKG23	
D529	8-719-302-43	DIODE RGP10GPKG23	
D530	8-719-991-33	DIODE 1SS133T-77	
D531	8-719-991-33	DIODE 1SS133T-77	
D532	8-719-908-03	DIODE GP08DPKG23	
D533	8-719-302-43	DIODE RGP10GPKG23	
D534	8-719-302-43	DIODE RGP10GPKG23	
D601	8-719-068-00	DIODE ERC04-06SE	
D602	8-719-068-00	DIODE ERC04-06SE	
D603	Δ 8-719-510-53	DIODE D4SB60L-F	
D604	8-719-110-41	DIODE MTZJ-T-77-15B	
D605	8-719-110-49	DIODE MTZJ-T-77-18B	
D607	8-719-991-33	DIODE 1SS133T-77	
D609	8-719-948-45	DIODE ERA22-08TP3	
D610	8-719-510-48	DIODE D1N20R-TA	
D650	8-719-028-45	DIODE D2L20U-F	
D651	8-719-063-70	DIODE D1NL20U-TA	
D652	8-719-028-45	DIODE D2L20U-F	
D653	8-719-028-45	DIODE D2L20U-F	



Les composants identifiés par une trame et une marque Δ sont critiques pour la sécurité. Ne les remplacer que par une pièce portant le numéro spécifié.

The components identified by shading and mark Δ are critical for safety. Replace only with part number specified.

REF. NO.	PART NO.	DESCRIPTION	REMARK	REF. NO.	PART NO.	DESCRIPTION	REMARK
D654	8-719-057-96	DIODE D10SC6M-4012		IC502	8-759-133-90	IC μ PC339C	
D655	8-719-052-91	DIODE D4SBS4-F		IC601 Δ	8-729-045-39	TRANSISTOR MX0842AB-F	
D656	8-719-028-45	DIODE D2L20U-F		IC651	8-759-103-93	IC μ PC393C	
D657	8-719-028-45	DIODE D2L20U-F		IC652	8-759-701-84	IC NJM7905FA	
D658	8-719-063-70	DIODE D1NL20U-TA		IC653	8-759-701-75	IC NJM7805FA	
D659	8-719-063-70	DIODE D1NL20U-TA		IC654 Δ	8-749-012-13	IC DM-58	
D660	8-719-028-45	DIODE D2L20U-F		IC655	8-759-450-47	IC BA05T	
D661	8-719-991-33	DIODE 1SS133T-77		IC1501	8-752-068-36	IC CXA1726AS	
D662	8-719-991-33	DIODE 1SS133T-77		IC1502	8-749-014-37	IC STK392-150	
D663	8-719-991-33	DIODE 1SS133T-77		IC1504	8-759-634-51	IC NJM4558D	
D664	8-719-981-94	DIODE MTZJ-T-77-2.7A		IC1505	8-759-634-51	IC NJM4558D	
D665	8-719-991-33	DIODE 1SS133T-77		IC1506	8-749-014-37	IC STK392-150	
D666	8-719-991-33	DIODE 1SS133T-77		IC1507	8-759-634-51	IC NJM4558D	
D667	8-719-032-12	DIODE D1NS6-TR		IC1509	8-759-593-33	IC LA78045	
D668	8-719-110-61	DIODE MTZJ-T-77-24A				<COIL>	
D669	8-719-921-86	DIODE MTZJ-T-77-13		L501	1-412-533-21	INDUCTOR 47 μ H	
D670	8-719-027-22	DIODE D3S6M-F		L502	1-414-187-11	INDUCTOR 47 μ H	
D671	8-719-027-22	DIODE D3S6M-F		L503	1-459-104-00	COIL, DUST CORE	
D672	8-719-200-82	DIODE 11ES2-TA2B		L504 Δ	1-419-082-11	COIL, HORIZONTAL LINEARITY	
D673	8-719-991-33	DIODE 1SS133T-77		L505	1-412-552-11	INDUCTOR 2.2mH	
D674	8-719-991-33	DIODE 1SS133T-77		L601 Δ	1-433-900-11	TRANSFORMER, LINE FILTER	
D675	8-719-110-17	DIODE MTZJ-T-77-10B		L651	1-419-389-21	INDUCTOR 8.2 μ H	
D676	8-719-109-72	DIODE MTZJ-T-77-3.9B		L652	1-419-389-21	INDUCTOR 8.2 μ H	
D677	8-719-991-33	DIODE 1SS133T-77		L653	1-406-975-21	INDUCTOR 47 μ H	
D680	8-719-991-33	DIODE 1SS133T-77		L654	1-410-396-41	FERRITE 0.45 μ H	
D1501	8-719-109-89	DIODE MTZJ-T-77-5.6B		L655	1-410-396-41	FERRITE 0.45 μ H	
D1503	8-719-921-40	DIODE MTZJ-T-77-4.7B		L656	1-412-525-31	INDUCTOR 10 μ H	
D1504	8-719-110-08	DIODE MTZJ-T-77-8.2B		L657	1-412-525-31	INDUCTOR 10 μ H	
D1505	8-719-110-41	DIODE MTZJ-T-77-15B		L658	1-412-525-31	INDUCTOR 10 μ H	
D1506	8-719-110-41	DIODE MTZJ-T-77-15B		L659	1-412-521-31	INDUCTOR 4.7 μ H	
D1507	8-719-110-41	DIODE MTZJ-T-77-15B		L660	1-412-521-31	INDUCTOR 4.7 μ H	
D1509	8-719-110-41	DIODE MTZJ-T-77-15B		L1501	1-412-533-21	INDUCTOR 47 μ H	
D1510	8-719-110-41	DIODE MTZJ-T-77-15B		L1502	1-412-533-21	INDUCTOR 47 μ H	
D1513	8-719-110-41	DIODE MTZJ-T-77-15B		L1509	1-412-533-21	INDUCTOR 47 μ H	
D1515	8-719-110-41	DIODE MTZJ-T-77-15B		L1510	1-412-533-21	INDUCTOR 47 μ H	
D1520	8-719-109-93	DIODE MTZJ-T-77-6.2B		L1511	1-412-533-21	INDUCTOR 47 μ H	
D1521	8-719-109-93	DIODE MTZJ-T-77-6.2B		L1512	1-412-533-21	INDUCTOR 47 μ H	
D1522	8-719-924-16	DIODE MTZJ-T-77-24		L1513	1-412-525-31	INDUCTOR 10 μ H	
D1523	8-719-924-16	DIODE MTZJ-T-77-24		L1514	1-412-911-11	FERRITE 0 μ H	
D1525	8-719-908-03	DIODE GP08DPKG23		L1515	1-412-911-11	FERRITE 0 μ H	
JW168	8-719-018-82	DIODE RGP02-20EL-6394				<NEON LAMP>	
		<FUSE>		NL501	1-517-778-21	LAMP, NEON	
F601 Δ	1-576-193-11	FUSE 6.3A/125V		NL502	1-517-778-21	LAMP, NEON	
F651 Δ	1-576-360-21	FUSE, MULTIPLE 4A		NL503	1-517-778-21	LAMP, NEON	
F652 Δ	1-576-360-21	FUSE, MULTIPLE 4A		NL504	1-517-778-21	LAMP, NEON	
		<FERRITE BEAD>		NL505	1-517-778-21	LAMP, NEON	
FB651	1-410-396-41	FERRITE 0.45 μ H				<IC LINK>	
FB655	1-410-396-41	FERRITE 0.45 μ H		PS501	1-533-593-11	LINK, IC	
FB656	1-410-396-41	FERRITE 0.45 μ H		PS1501	1-533-593-11	LINK, IC	
FB657	1-410-396-41	INDUCTOR 0.45 μ H		PS1502	1-533-593-11	LINK, IC	
		<IC>		PS1503	1-533-593-11	LINK, IC	
				PS1504	1-533-593-11	LINK, IC	

**KP-43T75/48S75/
53N77/53S75/61S75
RM-Y906**



• The components identified by **▶** in this manual have been carefully factory-selected for each set in order to satisfy regulations regarding X-ray radiation. Should replacement be required, replace only with the value originally used.

Les composants identifiés par une trame et une marque **△** sont critiques pour la sécurité. Ne les remplacer que par une pièce portant le numéro spécifique.

The components identified by shading and mark **△** are critical for safety. Replace only with part number specified.

REF. NO.	PART NO.	DESCRIPTION	REMARK	REF. NO.	PART NO.	DESCRIPTION	REMARK
PS1505	1-533-593-11	LINK, IC		R530	1-249-428-11	CARBON	8.2K 5% 1/4W
PS1506	1-533-593-11	LINK, IC		R531	1-249-429-11	CARBON	10K 5% 1/4W
		<TRANSISTOR>		R532	1-249-430-11	CARBON	12K 5% 1/4W
Q501	8-729-048-47	TRANSISTOR	2SC2688(5)-LK	R535	1-247-887-00	CARBON	220K 5% 1/4W
Q502	8-729-048-46	TRANSISTOR	2SD2578-RF	▶ R536	△	METAL	1/4W
Q503	8-729-931-45	TRANSISTOR	IRF614-LF	R537	1-247-863-91	CARBON	22K 5% 1/4W
Q505	8-729-032-61	TRANSISTOR	2SC5022-02	R538	1-215-443-00	METAL	8.2K 1% 1/4W
Q506	8-729-119-76	TRANSISTOR	2SA1309A-QRSTA	R542	1-249-424-11	CARBON	3.9K 5% 1/4W
Q507	8-729-032-61	TRANSISTOR	2SC5022-02	R543	1-260-135-11	CARBON	1M 5% 1/2W
Q601	8-729-046-40	TRANSISTOR	2SK2663	R544	1-249-405-11	CARBON	100 5% 1/4W
Q602	8-729-922-39	TRANSISTOR	2SD2144S-TP-V	▶ R545	△	METAL	1/4W
Q651	8-729-119-76	TRANSISTOR	2SA1309A-QRSTA	R546	1-215-456-00	METAL	30K 1% 1/4W
Q652	8-729-922-39	TRANSISTOR	2SD2144S-TP-V	R548	1-215-449-00	METAL	15K 1% 1/4W
Q653	8-729-119-76	TRANSISTOR	2SA1309A-QRSTA	R550	1-215-910-00	METAL OXIDE	68 5% 3W
Q654	8-729-119-76	TRANSISTOR	2SA1309A-QRSTA	R551	1-215-910-00	METAL OXIDE	68 5% 3W
Q655	8-729-423-33	TRANSISTOR	2SC3311A-QRSTA	R556	1-249-437-11	CARBON	47K 5% 1/4W
Q656	8-729-423-33	TRANSISTOR	2SC3311A-QRSTA	R563	1-247-887-00	CARBON	220K 5% 1/4W
Q657	8-729-119-76	TRANSISTOR	2SA1309A-QRSTA	R566	1-215-868-00	METAL OXIDE	680 5% 1W
Q658	8-729-119-76	TRANSISTOR	2SA1309A-RTA	R567	1-249-437-11	CARBON	47K 5% 1/4W
Q1501	8-729-423-33	TRANSISTOR	2SC3311A-QRSTA	R568	1-249-405-11	CARBON	100 5% 1/4W
Q1502	8-729-119-76	TRANSISTOR	2SA1309A-QRSTA	R569	1-260-314-11	CARBON	68 5% 1/2W
Q1503	8-729-423-33	TRANSISTOR	2SC3311A-QRSTA	R570	1-247-807-31	CARBON	100 5% 1/4W
Q1505	8-729-423-33	TRANSISTOR	2SC3311A-QRSTA	R571	1-215-917-11	METAL OXIDE	1K 5% 3W
Q1506	8-729-423-33	TRANSISTOR	2SC3311A-QRSTA	R572	1-216-490-11	METAL OXIDE	39K 5% 3W
Q1508	8-729-423-33	TRANSISTOR	2SC3311A-QRSTA	R573	1-214-912-00	METAL	91K 1% 1/2W
Q1509	8-729-119-76	TRANSISTOR	2SA1309A-QRSTA	R574	1-216-490-11	METAL OXIDE	39K 5% 3W
Q1511	8-729-423-33	TRANSISTOR	2SC3311A-QRSTA	R575	1-247-863-91	CARBON	22K 5% 1/4W
		<RESISTOR>		R576	1-247-881-00	CARBON	120K 5% 1/4W
R501	1-247-843-11	CARBON	3.3K 5% 1/4W	R577	1-214-923-00	METAL	270K 1% 1/2W
R502	1-249-419-11	CARBON	1.5K 5% 1/4W	R578	1-216-490-11	METAL OXIDE	39K 5% 3W
R503	1-260-336-11	CARBON	4.7K 5% 1/2W	R579	1-216-490-11	METAL OXIDE	39K 5% 3W
R504	1-260-087-11	CARBON	100 5% 1/2W	R580	1-249-413-11	CARBON	470 5% 1/4W
R505	1-260-087-11	CARBON	100 5% 1/2W	R581	1-247-807-31	CARBON	100 5% 1/4W
R506	1-216-481-11	METAL OXIDE	1.2K 5% 3W	R582	1-260-292-11	CARBON	1 5% 1/2W
R507	1-216-481-11	METAL OXIDE	1.2K 5% 3W	R583	1-260-117-11	CARBON	33K 5% 1/2W
R508	1-216-481-11	METAL OXIDE	1.2K 5% 3W	R584	1-249-377-11	CARBON	0.47 5% 1/4W
R509	1-260-337-11	CARBON	5.6K 5% 1/2W	R586	1-215-862-11	METAL OXIDE	68 5% 1W (48S75/61S75)
R510	1-249-421-11	CARBON	2.2K 5% 1/4W	R586	1-215-863-11	METAL OXIDE	100 5% 1W (43T75)
R511	1-215-879-11	METAL OXIDE	47K 5% 1W	R586	1-215-864-00	METAL OXIDE	150 5% 1W (53N77/53S75)
R512	1-249-422-11	CARBON	2.7K 5% 1/4W	R587	1-216-349-00	METAL OXIDE	1 5% 1W
R513	1-249-422-11	CARBON	2.7K 5% 1/4W	R588	1-215-862-11	METAL OXIDE	68 5% 1W (48S75/61S75)
R514	1-249-422-11	CARBON	2.7K 5% 1/4W	R588	1-215-863-11	METAL OXIDE	100 5% 1W (43T75)
R515	1-260-131-11	CARBON	470K 5% 1/2W	R588	1-215-864-00	METAL OXIDE	150 5% 1W (53N77/53S75)
R517	1-247-891-00	CARBON	330K 5% 1/4W	R589	1-247-807-31	CARBON	100 5% 1/4W
R519	1-215-445-00	METAL	10K 1% 1/4W	R590	1-260-127-11	CARBON	220K 5% 1/2W
R522	1-215-399-00	METAL	120 1% 1/4W	R591	1-216-391-11	METAL OXIDE	1.5 5% 3W (53S75/61S75 Serial No. 9,500,001-)
R523	1-247-895-91	CARBON	470K 5% 1/4W	R591	1-216-392-11	METAL OXIDE	1.8 5% 3W (EXCET 53S75/61S75 Serial No. 9,500,001-)
R524	1-247-863-91	CARBON	22K 5% 1/4W	R592	1-247-863-91	CARBON	22K 5% 1/4W
R525	1-249-428-11	CARBON	8.2K 5% 1/4W	R593	1-249-429-11	CARBON	10K 5% 1/4W
R526	1-249-437-11	CARBON	47K 5% 1/4W				
R527	1-249-428-11	CARBON	8.2K 5% 1/4W				
R528	1-249-437-11	CARBON	47K 5% 1/4W				
R529	1-249-439-11	CARBON	68K 5% 1/4W				

Les composants identifiés par une trame et une marque Δ sont critiques pour la sécurité. Ne les remplacer que par une pièce portant le numéro spécifié.

The components identified by shading and mark Δ are critical for safety. Replace only with part number specified.



REF. NO.	PART NO.	DESCRIPTION			REMARK	REF. NO.	PART NO.	DESCRIPTION			REMARK
R594	1-249-377-11	CARBON	0.47	5%	1/4W	R680	1-249-429-11	CARBON	10K	5%	1/4W
R595	1-249-377-11	CARBON	0.47	5%	1/4W	R681	1-249-429-11	CARBON	10K	5%	1/4W
R596	1-249-377-11	CARBON	0.47	5%	1/4W	R682	1-249-417-11	CARBON	1K	5%	1/4W
R597	1-260-288-11	CARBON	0.47	5%	1/2W	R683	1-249-417-11	CARBON	1K	5%	1/4W
R598	1-249-377-11	CARBON	0.47	5%	1/4W	R684	1-249-425-11	CARBON	4.7K	5%	1/4W
R599	1-249-429-11	CARBON	10K	5%	1/4W	R685	1-249-417-11	CARBON	1K	5%	1/4W
R600	1-247-863-91	CARBON	22K	5%	1/4W	R686	1-215-445-00	METAL	10K	1%	1/4W
R601 Δ	1-219-776-11	CARBON	2.2M	10%	1/2W	R687	1-215-429-00	METAL	2.2K	1%	1/4W
R602 Δ	1-219-759-11	CARBON	1M	5%	1/2W	R688	1-215-429-00	METAL	2.2K	1%	1/4W
R603 Δ	1-240-881-11	CMT-MELF	0.82	5%	20W	R689	1-249-417-11	CARBON	1K	5%	1/4W
R604	1-260-298-51	CARBON	3.3	5%	1/2W	R690	1-215-437-00	METAL	4.7K	1%	1/4W
R605	1-249-415-11	CARBON	680	5%	1/4W	R691	1-249-417-11	CARBON	1K	5%	1/4W
R606 Δ	1-240-881-11	CMT-MELF	0.82	5%	20W	R1501	1-214-800-11	METAL	2.2	1%	1/2W
R607	1-249-389-11	CARBON	4.7	5%	1/4W	R1502	1-214-800-11	METAL	2.2	1%	1/2W
R608	1-247-791-91	CARBON	22	5%	1/4W	R1503	1-215-421-00	METAL	1K	1%	1/4W
R609	1-240-205-91	CARBON	22M	5%	1/2W	R1504	1-215-433-00	METAL	3.3K	1%	1/4W
R610	1-260-127-11	CARBON	220K	5%	1/2W	R1505	1-247-815-91	CARBON	220	5%	1/4W
R611	1-260-127-11	CARBON	220K	5%	1/2W	R1506	1-247-815-91	CARBON	220	5%	1/4W
R612 Δ	1-202-933-61	FUSIBLE	0.1	10%	1/2W	R1507	1-215-433-00	METAL	3.3K	1%	1/4W
R613	1-249-413-11	CARBON	470	5%	1/4W	R1508	1-215-421-00	METAL	1K	1%	1/4W
R615	1-249-437-11	CARBON	47K	5%	1/4W	R1509	1-214-800-11	METAL	2.2	1%	1/2W
R616	1-249-421-11	CARBON	2.2K	5%	1/4W	R1510	1-214-800-11	METAL	2.2	1%	1/2W
R617	1-216-349-00	METAL OXIDE	1	5%	1W	R1511	1-214-800-11	METAL	2.2	1%	1/2W
R618	1-260-127-11	CARBON	220K	5%	1/2W	R1512	1-214-800-11	METAL	2.2	1%	1/2W
R619	1-216-349-00	METAL OXIDE	1	5%	1W	R1513	1-215-421-00	METAL	1K	1%	1/4W
R620	1-215-493-00	METAL	1M	1%	1/4W	R1514	1-215-433-00	METAL	3.3K	1%	1/4W
R621	1-260-127-11	CARBON	220K	5%	1/2W	R1515	1-247-815-91	CARBON	220	5%	1/4W
R622	1-249-441-11	CARBON	100K	5%	1/4W	R1516	1-249-429-11	CARBON	10K	5%	1/4W
R623	1-260-127-11	CARBON	220K	5%	1/2W	R1517	1-247-887-00	CARBON	220K	5%	1/4W
R624	1-260-127-11	CARBON	220K	5%	1/2W	R1518	1-249-429-11	CARBON	10K	5%	1/4W
R652	1-249-377-11	CARBON	0.47	5%	1/4W	R1519	1-249-437-11	CARBON	47K	5%	1/4W
R654	1-216-365-00	METAL OXIDE	0.47	5%	2W	R1520	1-247-881-00	CARBON	120K	5%	1/4W
R655	1-260-288-11	CARBON	0.47	5%	1/2W	R1521	1-215-474-00	METAL	160K	1%	1/4W
R656	1-249-377-11	CARBON	0.47	5%	1/4W	R1522	1-214-800-11	METAL	2.2	1%	1/2W
R657	1-215-421-00	METAL	1K	1%	1/4W	R1523	1-214-800-11	METAL	2.2	1%	1/2W
R658	1-249-429-11	CARBON	10K	5%	1/4W	R1524	1-215-421-00	METAL	1K	1%	1/4W
R659	1-215-446-00	METAL	11K	1%	1/4W	R1525	1-215-433-00	METAL	3.3K	1%	1/4W
R660	1-215-439-00	METAL	5.6K	1%	1/4W	R1526	1-247-815-91	CARBON	220	5%	1/4W
R661	1-215-481-00	METAL	330K	1%	1/4W	R1527	1-247-815-91	CARBON	220	5%	1/4W
R662	1-215-445-00	METAL	10K	1%	1/4W	R1528	1-215-433-00	METAL	3.3K	1%	1/4W
R663	1-215-445-00	METAL	10K	1%	1/4W	R1529	1-215-421-00	METAL	1K	1%	1/4W
R664	1-249-425-11	CARBON	4.7K	5%	1/4W	R1530	1-214-800-11	METAL	2.2	1%	1/2W
R665	1-249-425-11	CARBON	4.7K	5%	1/4W	R1531	1-214-800-11	METAL	2.2	1%	1/2W
R666	1-247-887-00	CARBON	220K	5%	1/4W	R1532	1-214-800-11	METAL	2.2	1%	1/2W
R667	1-249-425-11	CARBON	4.7K	5%	1/4W	R1533	1-249-441-11	CARBON	100K	5%	1/4W
R668	1-249-429-11	CARBON	10K	5%	1/4W	R1534	1-214-800-11	METAL	2.2	1%	1/2W
R669	1-247-807-31	CARBON	100	5%	1/4W	R1535	1-215-421-00	METAL	1K	1%	1/4W
R670	1-249-417-11	CARBON	1K	5%	1/4W	R1536	1-215-433-00	METAL	3.3K	1%	1/4W
R671	1-249-429-11	CARBON	10K	5%	1/4W	R1537	1-247-815-91	CARBON	220	5%	1/4W
R672	1-249-417-11	CARBON	1K	5%	1/4W	R1538	1-249-429-11	CARBON	10K	5%	1/4W
R673	1-249-425-11	CARBON	4.7K	5%	1/4W	R1539	1-249-428-11	CARBON	8.2K	5%	1/4W
R675	1-249-429-11	CARBON	10K	5%	1/4W	R1540	1-249-417-11	CARBON	1K	5%	1/4W
R676	1-249-417-11	CARBON	1K	5%	1/4W	R1541	1-247-843-11	CARBON	3.3K	5%	1/4W
R677	1-249-417-11	CARBON	1K	5%	1/4W	R1542	1-249-429-11	CARBON	10K	5%	1/4W
R678	1-249-425-11	CARBON	4.7K	5%	1/4W	R1543	1-249-429-11	CARBON	10K	5%	1/4W
R679	1-247-807-31	CARBON	100	5%	1/4W	R1544	1-249-419-11	CARBON	1.5K	5%	1/4W
						R1548	1-249-438-11	CARBON	56K	5%	1/4W

Les composants identifiés par une trame et une marque Δ sont critiques pour la sécurité. Ne les remplacer que par une pièce portant le numéro spécifié.

The components identified by shading and mark Δ are critical for safety. Replace only with part number specified.



REF. NO.	PART NO.	DESCRIPTION	REMARK	REF. NO.	PART NO.	DESCRIPTION	REMARK
		<DIODE>					
D705	8-719-991-33	DIODE 1SS133T-77					
D706	8-719-991-33	DIODE 1SS133T-77					
D707	8-719-991-33	DIODE 1SS133T-77					
D708	8-719-991-33	DIODE 1SS133T-77					
D709	8-719-991-33	DIODE 1SS133T-77					
		<COIL>					
L701	1-414-188-41	INDUCTOR 68 μ H					
L702	1-412-911-11	FERRITE 0 μ H					
		<NEON LAMP>					
NL701	1-517-778-21	LAMP, NEON					
		<TRANSISTOR>					
Q704	8-729-423-33	TRANSISTOR 2SC3311A-QRSTA					
Q705	8-729-326-11	TRANSISTOR 2SC2611					
Q706	8-729-200-17	TRANSISTOR 2SA1091-O					
		<RESISTOR>					
R701	1-219-743-11	CARBON 100 5% 1/2W					
R702	1-260-132-11	CARBON 560K 5% 1/2W					
R703	1-216-486-00	METAL OXIDE 8.2K 5% 3W F					
R704	1-215-476-00	METAL 200K 1% 1/4W					
R711	1-247-807-31	CARBON 100 5% 1/4W					
R712	1-249-404-00	CARBON 82 5% 1/4W					
R713	1-216-486-00	METAL OXIDE 8.2K 5% 3W F					
R714	1-249-393-11	CARBON 10 5% 1/4W					
R715	1-249-419-11	CARBON 1.5K 5% 1/4W					
R718	1-260-133-11	CARBON 680K 5% 1/2W					
R719	1-249-425-11	CARBON 4.7K 5% 1/4W					
R720	1-260-099-11	CARBON 1K 5% 1/2W					
R721	1-260-099-11	CARBON 1K 5% 1/2W					
R722	1-260-087-11	CARBON 100 5% 1/2W					
R723	1-412-911-11	FERRITE 0 μ H					
		<SPARK GAP>					
SG701	1-519-422-11	GAP, SPARK					
SG702	1-517-729-31	GAP, SPARK					
		<TEST PIN>					
TP701	* 1-535-881-21	TERMINAL, TP (AUTO INSERTION)					

		<DIODE>					
D731	8-719-991-33	DIODE 1SS133T-77					
D732	8-719-991-33	DIODE 1SS133T-77					
D733	8-719-991-33	DIODE 1SS133T-77					
D734	8-719-991-33	DIODE 1SS133T-77					
D735	8-719-991-33	DIODE 1SS133T-77					
D736	8-719-109-85	DIODE RD5.1ES-B2					
D1304	8-719-991-33	DIODE 1SS133T-77					
		<COIL>					
L731	1-414-188-41	INDUCTOR 68 μ H					
L732	1-412-911-11	FERRITE 0 μ H					

* A-1331-923-A CG BOARD, COMPLETE

4-382-854-11 SCREW (M3X10), P, SW (+)

<CAPACITOR>

C731 1-104-664-11 ELECT 47 μ F 20% 25V
C732 1-104-570-11 CERAMIC 0.001 μ F 10% 2KV
C733 1-102-114-00 CERAMIC 470PF 10% 50V
C734 1-102-114-00 CERAMIC 470PF 10% 50V
C735 1-101-880-00 CERAMIC 47PF 5% 50V

C736 1-161-830-00 CERAMIC 0.0047 μ F 500V
C737 1-162-115-00 CERAMIC 330PF 10% 2KV
C738 1-107-662-11 ELECT 22 μ F 20% 250V
C1301 1-106-343-00 MYLAR 0.001 μ F 10% 200V
C1302 1-107-639-11 ELECT 47 μ F 20% 160V

C1303 1-126-933-11 ELECT 100 μ F 20% 16V
C1305 1-126-933-11 ELECT 100 μ F 20% 16V
C1308 1-106-383-00 MYLAR 0.047 μ F 10% 200V
C1309 1-106-383-00 MYLAR 0.047 μ F 10% 200V
C1310 1-126-960-11 ELECT 1 μ F 20% 50V

C1312 1-161-830-00 CERAMIC 0.0047 μ F 500V
C1313 1-102-129-00 CERAMIC 0.01 μ F 10% 50V
C1314 1-102-129-00 CERAMIC 0.01 μ F 10% 50V
C1315 1-126-933-11 ELECT 100 μ F 20% 16V

<CONNECTOR>

CN731 * 1-564-512-11 PLUG, CONNECTOR 9P
CN732 * 1-564-507-11 PLUG, CONNECTOR 4P
CN733 * 1-564-508-11 PLUG, CONNECTOR 5P
CN734 * 1-564-513-11 PLUG, CONNECTOR 10P
CN735 * 1-564-512-11 PLUG, CONNECTOR 9P

CN736 * 1-564-512-11 PLUG, CONNECTOR 9P
CN737 1-785-879-11 CONNECTOR, ONE TOUCH
CN738 1-695-915-11 TAB (CONTACT)
CN739 1-695-915-11 TAB (CONTACT)
CN740 Δ 1-251-182-11 SOCKET, CRT

CN1301* 1-564-506-11 PLUG, CONNECTOR 3P
CN1302* 1-564-506-11 PLUG, CONNECTOR 3P
CN1303* 1-564-506-11 PLUG, CONNECTOR 3P
CN1304* 1-564-509-11 PLUG, CONNECTOR 6P

<DIODE>

D731 8-719-991-33 DIODE 1SS133T-77
D732 8-719-991-33 DIODE 1SS133T-77
D733 8-719-991-33 DIODE 1SS133T-77
D734 8-719-991-33 DIODE 1SS133T-77
D735 8-719-991-33 DIODE 1SS133T-77

D736 8-719-109-85 DIODE RD5.1ES-B2
D1304 8-719-991-33 DIODE 1SS133T-77

<COIL>

L731 1-414-188-41 INDUCTOR 68 μ H
L732 1-412-911-11 FERRITE 0 μ H

CG

CB

Les composants identifiés par une trame et une marque Δ sont critiques pour la sécurité. Ne les remplacer que par une pièce portant le numéro spécifié.

The components identified by shading and mark Δ are critical for safety. Replace only with part number specified.

REF. NO.	PART NO.	DESCRIPTION	REMARK
L1301	1-412-911-11	FERRITE	0 μ H
L1302	1-412-911-11	FERRITE	0 μ H
<NEON LAMP>			
NL731	1-517-778-21	LAMP, NEON	
<TRANSISTOR>			
Q731	8-729-423-33	TRANSISTOR	2SC3311A-QRSTA
Q732	8-729-326-11	TRANSISTOR	2SC2611
Q733	8-729-200-17	TRANSISTOR	2SA1091-O
Q734	8-729-119-76	TRANSISTOR	2SA1175-HFE
Q1301	8-729-017-06	TRANSISTOR	2SC4793
Q1302	8-729-017-05	TRANSISTOR	2SA1837
Q1303	8-729-119-76	TRANSISTOR	2SA1175-HFE
Q1304	8-729-423-33	TRANSISTOR	2SC3311A-QRSTA
Q1305	8-729-423-33	TRANSISTOR	2SC3311A-QRSTA
Q1306	8-729-423-33	TRANSISTOR	2SC3311A-QRSTA
<RESISTOR>			
R731	1-219-743-11	CARBON	100 5% 1/2W
R732	1-260-132-11	CARBON	560K 5% 1/2W
R733	1-247-807-31	CARBON	100 5% 1/4W
R734	1-260-087-11	CARBON	100 5% 1/2W
R735	1-249-403-11	CARBON	68 5% 1/4W
R736	1-216-486-00	METAL OXIDE	8.2K 5% 3W F
R737	1-249-393-11	CARBON	10 5% 1/4W
R738	1-249-414-11	CARBON	560 5% 1/4W
R739	1-216-486-00	METAL OXIDE	8.2K 5% 3W F
R741	1-249-425-11	CARBON	4.7K 5% 1/4W
R742	1-260-099-11	CARBON	1K 5% 1/2W
R743	1-247-881-00	CARBON	120K 5% 1/4W
R744	1-260-133-11	CARBON	680K 5% 1/2W
R745	1-260-099-11	CARBON	1K 5% 1/2W
R746	1-249-437-11	CARBON	47K 5% 1/4W
R747	1-249-438-11	CARBON	56K 5% 1/4W
R753	1-412-911-11	FERRITE	0 μ H
R1301	1-215-916-11	METAL OXIDE	680 5% 3W F
R1302	1-215-916-11	METAL OXIDE	680 5% 3W F
R1303	1-249-400-11	CARBON	39 5% 1/4W F
R1304	1-249-391-11	CARBON	6.8 5% 1/4W F
R1305	1-249-391-11	CARBON	6.8 5% 1/4W F
R1306	1-249-429-11	CARBON	10K 5% 1/4W
R1307	1-260-311-11	CARBON	39 5% 1/2W
R1308	1-249-419-11	CARBON	1.5K 5% 1/4W
R1310	1-249-441-11	CARBON	100K 5% 1/4W
R1311	1-249-419-11	CARBON	1.5K 5% 1/4W F
R1314	1-249-419-11	CARBON	1.5K 5% 1/4W
R1315	1-249-399-11	CARBON	33 5% 1/4W
R1319	1-249-413-11	CARBON	470 5% 1/4W
R1321	1-249-406-11	CARBON	120 5% 1/4W
R1323	1-249-377-11	CARBON	0.47 5% 1/4W F
R1324	1-249-425-11	CARBON	4.7K 5% 1/4W
R1325	1-249-431-11	CARBON	15K 5% 1/4W
R1327	1-249-441-11	CARBON	100K 5% 1/4W

REF. NO.	PART NO.	DESCRIPTION	REMARK
R1328	1-249-435-11	CARBON	33K 5% 1/4W
<SPARK GAP>			
SG731	1-519-422-11	GAP, SPARK	
SG732	1-517-729-31	GAP, SPARK	
<TEST PIN>			
TP731	* 1-535-881-21	TERMINAL, TP (AUTO INSERTION)	
TP732	* 1-535-881-21	TERMINAL, TP (AUTO INSERTION)	
TP733	* 1-535-881-21	TERMINAL, TP (AUTO INSERTION)	

* A-1331-924-A CB BOARD, COMPLETE *****			
4-382-854-11		SCREW (M3X10), P, SW (+)	
<CAPACITOR>			
C761	1-104-664-11	ELECT	47 μ F 20% 25V
C762	1-104-570-11	CERAMIC	0.001 μ F 10% 2KV
C763	1-102-114-00	CERAMIC	470PF 10% 50V
C764	1-102-112-00	CERAMIC	330PF 10% 50V
C765	1-101-880-00	CERAMIC	47PF 5% 50V
C767	1-162-115-00	CERAMIC	330PF 10% 2KV
C768	1-126-964-11	ELECT	10 μ F 20% 50V
C769	1-161-830-00	CERAMIC	0.0047 μ F 500V
C770	1-107-662-11	ELECT	22 μ F 20% 250V
<CONNECTOR>			
CN761	* 1-564-508-11	PLUG, CONNECTOR	5P
CN762	* 1-564-512-11	PLUG, CONNECTOR	9P
CN763	1-785-879-11	CONNECTOR, ONE TOUCH	
CN764	1-695-915-11	TAB (CONTACT)	
CN765	1-695-915-11	TAB (CONTACT)	
CN766 Δ	1-251-182-11	SOCKET, CRT	
<DIODE>			
D761	8-719-991-33	DIODE	1SS133T-77
D762	8-719-991-33	DIODE	1SS133T-77
D763	8-719-991-33	DIODE	1SS133T-77
D764	8-719-991-33	DIODE	1SS133T-77
D765	8-719-991-33	DIODE	1SS133T-77
<COIL>			
L761	1-414-188-41	INDUCTOR	68 μ H
L762	1-412-911-11	FERRITE	0 μ H
<NEON LAMP>			
NL761	1-517-778-21	LAMP, NEON	



REF. NO.	PART NO.	DESCRIPTION	REMARK
<TRANSISTOR>			
Q761	8-729-423-33	TRANSISTOR 2SC3311A-QRSTA	
Q762	8-729-326-11	TRANSISTOR 2SC2611	
Q763	8-729-119-76	TRANSISTOR 2SA1175-HFE	
Q764	8-729-200-17	TRANSISTOR 2SA1091-O	
<RESISTOR>			
R761	1-219-743-11	CARBON 100 5%	1/2W
R762	1-260-132-11	CARBON 560K 5%	1/2W
R763	1-247-807-31	CARBON 100 5%	1/4W
R764	1-216-486-00	METAL OXIDE 8.8K 5%	3W F
R765	1-247-807-31	CARBON 100 5%	1/4W
R766	1-216-486-00	METAL OXIDE 8.2K 5%	3W F
R767	1-249-393-11	CARBON 10 5%	1/4W
R768	1-249-418-11	CARBON 1.2K 5%	1/4W
R770	1-249-404-00	CARBON 82 5%	1/4W
R771	1-249-426-11	CARBON 5.6K 5%	1/4W
R772	1-249-435-11	CARBON 33K 5%	1/4W
R773	1-260-099-11	CARBON 1K 5%	1/2W
R775	1-249-425-11	CARBON 4.7K 5%	1/4W
R776	1-260-133-11	CARBON 680K 5%	1/2W
R777	1-260-099-11	CARBON 1K 5%	1/2W
R778	1-259-880-11	CARBON 2.2M 5%	1/2W
R779	1-260-087-11	CARBON 100 5%	1/2W
R783	1-412-911-11	FERRITE 0μH	
<SPARK GAP>			
SG761	1-519-422-11	GAP, SPARK	
SG762	1-517-729-31	GAP, SPARK	
<TEST PIN>			
TP761	* 1-535-881-21	TERMINAL, TP (AUTO INSERTION)	

* A-1372-618-A HC BOARD, COMPLETE

<CAPACITOR>			
C1291	1-126-791-11	ELECT 10μF 20%	16V
<CONNECTOR>			
CN1291*	1-564-518-11	PLUG, CONNECTOR 3P	
<DIODE>			
D1291	8-719-066-43	DIODE GP1U28Y	
D1292	8-719-109-89	DIODE RD5.6ESB2	
D1293	8-719-109-89	DIODE RD5.6ESB2	

REF. NO.	PART NO.	DESCRIPTION	REMARK
<RESISTOR>			
R1291	1-247-807-31	CARBON 100 5%	1/4W

* A-1372-619-A HA BOARD, COMPLETE *****			
<CONNECTOR>			
CN1202*	1-564-517-11	PLUG, CONNECTOR 2P	
CN1203*	1-564-522-11	PLUG, CONNECTOR 7P	
<DIODE>			
D1201	8-719-053-43	DIODE SLR-325VCT31	
<RESISTOR>			
R1201	1-249-431-11	CARBON 15K 5%	1/4W
R1202	1-249-425-11	CARBON 4.7K 5%	1/4W
R1203	1-249-417-11	CARBON 1K 5%	1/4W
R1204	1-249-419-11	CARBON 1.5K 5%	1/4W
R1205	1-249-421-11	CARBON 2.2K 5%	1/4W
R1206	1-247-815-91	CARBON 220 5%	1/4W
<SWITCH>			
S1201	1-572-198-11	SWITCH, KEYBOARD (FLASH FOCUS)	
S1202	1-572-198-11	SWITCH, KEYBOARD (TV/VIDEO)	
S1203	1-572-198-11	SWITCH, KEYBOARD (VOLUME -)	
S1204	1-572-198-11	SWITCH, KEYBOARD (VOLUME +)	
S1205	1-572-198-11	SWITCH, KEYBOARD (CHANNEL -)	
S1206	1-572-198-11	SWITCH, KEYBOARD (CHANNEL +)	
S1207	1-572-198-11	SWITCH, KEYBOARD (POWER)	

* A-1372-620-A HB BOARD, COMPLETE

<CAPACITOR>			
C1251	1-128-551-11	ELECT 22μF 20%	25V
C1252	1-128-551-11	ELECT 22μF 20%	25V
C1253	1-128-551-11	ELECT 22μF 20%	25V
C1254	1-128-551-11	ELECT 22μF 20%	25V
C1255	1-128-551-11	ELECT 22μF 20%	25V
<CONNECTOR>			
CN1252*	1-564-517-11	PLUG, CONNECTOR 2P	
CN1253*	1-564-526-11	PLUG, CONNECTOR 11P	



Les composants identifiés par une trame et une marque Δ sont critiques pour la sécurité. Ne les remplacer que par une pièce portant le numéro spécifié.

The components identified by shading and mark Δ are critical for safety. Replace only with part number specified.

REF. NO.	PART NO.	DESCRIPTION	REMARK
<DIODE>			
D1251	8-719-110-17	DIODE RD10ESB2	
D1252	8-719-110-17	DIODE RD10ESB2	
D1253	8-719-110-17	DIODE RD10ESB2	
D1254	8-719-110-17	DIODE RD10ESB2	
D1255	8-719-110-17	DIODE RD10ESB2	
D1256	8-719-110-17	DIODE RD10ESB2	
<JACK>			
J1251	1-770-361-11	TERMINAL BLOCK, S	
<RESISTOR>			
R1251	1-249-429-11	CARBON 10K 5% 1/4W	
R1252	1-249-424-11	CARBON 3.9K 5% 1/4W	
R1253	1-249-421-11	CARBON 2.2K 5% 1/4W	
R1254	1-249-418-11	CARBON 1.2K 5% 1/4W	
R1255	1-249-425-11	CARBON 4.7K 5% 1/4W	
R1256	1-247-804-11	CARBON 75 5% 1/4W	
R1257	1-247-895-91	CARBON 470K 5% 1/4W	
R1258	1-247-895-91	CARBON 470K 5% 1/4W	
R1259	1-247-804-11	CARBON 75 5% 1/4W	
R1260	1-247-804-11	CARBON 75 5% 1/4W	
<SWITCH>			
S1251	1-572-198-11	SWITCH, KEYBOARD (SELECT)	
S1252	1-572-198-11	SWITCH, KEYBOARD (+)	
S1253	1-572-198-11	SWITCH, KEYBOARD (-)	
S1254	1-572-198-11	SWITCH, KEYBOARD (MENU)	
S1255	1-572-198-11	SWITCH, KEYBOARD (SET UP)	

* A-1390-933-A S BOARD, COMPLETE			

<CONNECTOR>			
CN3001*	1-564-506-11	PLUG, CONNECTOR 3P	
<DIODE>			
D3001	8-719-109-89	DIODE RD5.6ESB2	
<SWITCH>			
S3001	1-528-911-21	BATTERY, SOLAR	

REF. NO.	PART NO.	DESCRIPTION	REMARK
MISCELLANEOUS			

Δ	1-223-925-11	RESISTOR ASSY (HIGH-VOLTAGE) (FOCUS PACK)	
Δ	1-451-469-21	COIL ASSY, VM (53S75/61S75 Serial No. 9,500,001-)	
Δ	1-451-496-11	DEFLECTION YOKE (EXCEPT 53S75/61S75 Serial No. 9,500,001-)	
Δ	1-451-496-21	DEFLECTION YOKE (53S75/61S75 Serial No. 9,500,001-)	
Δ	1-452-790-21	NECK ASSY (EXCEPT 53S75/61S75 Serial No. 9,500,001-)	
Δ	1-452-909-31	MAGNET ASSY, 4 POLE (EXCEPT 53S75/61S75 Serial No. 9,500,001-)	
Δ	1-453-238-31	FLAYBACK TRANS ASSY (T504)	
	1-500-021-11	CLAMP, SLEEVE FERRITE	
	1-529-396-11	SPEAKER (10cm) (EXCEPT 53N77)	
	1-529-401-11	SPEAKER (13cm) (53N77)	
	1-529-403-11	SPEAKER (6.6cm) (53N77)	
	1-556-945-21	CABLE, P-P	
*	1-557-056-31	CABLE, P-P	
Δ	1-790-001-11	CORD, AC POWER (WITH CONNECTOR) (43T75,48S75,61S75)	
Δ	1-790-130-11	CORD, AC POWER (WITH CONNECTOR) (53N77,53S75)	
Δ	8-598-414-20	CHANGER, ANTENNA AS-2F	
Δ	8-598-955-30	BLOCK ASSY, HIGH-VOLTAGE	
Δ	8-733-570-15	CRT 07MXC2(G)(HEATER) (EXCEPT 53S75/61S75 Serial No. 9,500,001-)	
Δ	8-733-571-15	CRT 07MXC2(R)(HEATER) (43T75)	
Δ	8-733-572-15	CRT 07MXC3(R)(HEATER) (48S75,53N77,53S75)	
Δ	8-733-573-15	CRT 07MXC4(R)(HEATER) (61S75)	
Δ	8-733-574-15	CRT 07MAC2(B)(HEATER) (43T75)	
Δ	8-733-575-15	CRT 07MAC3(B)(HEATER) (48S75,53N77,53S75)	
Δ	8-733-576-15	CRT 07MAC4(B)(HEATER) (61S75)	
Δ	A-1501-520-A	COUPLER ASSY, CRT (B) (61S75 Serial No. 9,500,001-)	
Δ	A-1501-521-A	COUPLER ASSY, CRT (R) (61S75 Serial No. 9,500,001-)	
Δ	A-1501-522-A	COUPLER ASSY, CRT (G) (53S75/61S75 Serial No. 9,500,001-)	
Δ	A-1501-526-A	COUPLER ASSY, CRT (R) (53S75 Serial No. 9,500,001-)	
Δ	A-1501-527-A	COUPLER ASSY, CRT (B) (53S75 Serial No. 9,500,001-)	

ACCESSORIES AND PACKING MATERIALS			

*	4-041-423-01	SHEET, PROTECTION (43T75/48S75)	
*	4-041-425-01	BAG, PROTECTION (48S75)	
*	4-041-426-01	BAG, PROTECTION (53N77/53S75)	
*	4-042-463-01	SHEET, PROTECTION (53N77/53S75/61S75)	
*	4-049-155-01	BAG, PROTECTION (43T75)	

<u>REF. NO.</u>	<u>PART NO.</u>	<u>DESCRIPTION</u>	<u>REMARK</u>
*	4-069-525-01	CUSHION (UPPER) (ASSY) (48S75)	
*	4-069-526-01	CUSHION (LOWER) (ASSY) (48S75)	
*	4-069-531-01	INDIVIDUAL CARTON (48S75)	
*	4-069-532-01	PLATE, BOTTOM (48S75)	
*	4-069-533-01	TRAY (48S75)	
*	4-069-537-01	ASSY, CUSHION (UPPER) (43T75)	
*	4-069-538-01	ASSY, CUSHION (LOWER) (43T75)	
*	4-069-543-01	INDIVIDUAL CARTON (43T75)	
*	4-069-545-01	TRAY (43T75)	
*	4-069-573-01	INDIVIDUAL CARTON (53N77/53S75)	
*	4-069-574-01	BOARD, BOTTOM (53N77/53S75)	
*	4-069-575-01	TRAY (53N77/53S75)	
*	4-069-576-01	CUSHION (UPPER) (ASSY) (53N77/53S75)	
*	4-069-577-01	CUSHION (LOWER) (ASSY) (53N77)	
*	4-069-582-01	INDIVIDUAL CARTON (61S75)	
*	4-069-583-01	BOARD, BOTTOM (61S75)	
*	4-069-584-01	TRAY (61S75)	
*	4-069-585-01	CUSHION (UPPER) (ASSY) (61S75)	
*	4-069-591-01	CUSHION (LOWER) (ASSY) (53S75)	
*	4-069-594-01	CUSHION (LOWER) (ASSY) (61S75)	
*	4-076-420-01	BAG, PROTECTION (61S75)	
	4-077-171-11	MANUAL, INSTRUCTION	
	4-077-171-21	MANUAL, INSTRUCTION	
	4-077-171-31	MANUAL, INSTRUCTION	
	4-077-171-41	MANUAL, INSTRUCTION	
		REMOTE COMMANDER	

	1-418-469-11	REMOTE COMMANDER (RM-Y906)	
	4-978-977-01	COVER, BATTERY (FOR RM-Y906)	

**KP-43T75/48S75/
53N77/53S75/61S75**
RM-Y906